

УДК: 517.938.5

MSC 2010: 37D15

Characteristic space of orbits of Morse-Smale diffeomorphisms on surfaces

E. V. Nozdrinova, O. V. Pochinka, E. V. Tsaplina

Nozdrinova Elena Vyacheslavovna, maati@mail.ru Laboratory of Dynamical Systems and Applications, NRU HSE, 25/12, Bolshaya Pecherskaya St., Nizhny Novgorod, Russia, 603155

Pochinka Olga Vitalievna, olga-pochinka@yandex.ru Laboratory of Dynamical Systems and Applications, NRU HSE, 25/12, Bolshaya Pecherskaya St., Nizhny Novgorod, Russia, 603155

Tsaplina Ekaterina Vadimovna, ktsaplina11@mail.ru Laboratory of Dynamical Systems and Applications, NRU HSE, 25/12, Bolshaya Pecherskaya St., Nizhny Novgorod, Russia, 603155

Abstract

The classical approach to the study of dynamical systems consists in representing the dynamics of the system in the form of a "source-sink", that means identifying an attractor-repeller pair, which are attractor-repellent sets for all other trajectories of the system. If there is a way to choose this pair so that the space orbits in its complement (the characteristic space of orbits) is connected, this creates prerequisites for finding complete topological invariants of the dynamical system. It is known that such a pair always exists for arbitrary Morse-Smale diffeomorphisms given on any manifolds of dimension $n \geq 3$. Whereas for $n = 2$ the existence of a connected characteristic space has been proved only for orientation-preserving gradient-like (without heteroclinic points) diffeomorphisms defined on an orientable surface. In the present work, it is constructively shown that the violation of at least one of the above conditions (absence of heteroclinic points, orientability of a surface, orientability of a diffeomorphism) leads to the existence of Morse-Smale diffeomorphisms on surfaces that do not have a connected characteristic space of orbits.

1 Introduction and the statement of the result

Let $f : M^n \rightarrow M^n$ be a Morse-Smale diffeomorphism defined on a closed connected n -manifold. Denote by Ω_f^0 , Ω_f^1 , Ω_f^2 the set of sinks, saddles, and sources of the diffeomorphism f . For any (possibly empty) f -invariant set $\Sigma \subset \Omega_f^1$ such that $cl(W_\Sigma^u) \setminus W_\Sigma^u \subset \Omega_f^0$, set

$$A_\Sigma = \Omega_f^0 \cup W_\Sigma^u, R_\Sigma = \Omega_f^2 \cup W_{\Omega_f^1 \setminus \Sigma}^s.$$

It follows from [13] that A_Σ and R_Σ are an attractor and a repeller, which are called *dual*. In the monograph [12] the set

$$V_\Sigma = M^n \setminus (A_\Sigma \cup R_\Sigma)$$

is called the *characteristic space*, and the orbit space \hat{V}_Σ of the action f on V_Σ is called the *characteristic space of orbits*.

There are a number of examples where a reasonable choice of a dual pair leads to a complete topological classification of some subset of Morse-Smale dynamical systems (look, for example, [1], [2], [8], [10], [3], and an overview of [9]). In most cases, finding complete topological invariants is based on the existence of a connected characteristic space of orbits for the class of systems under consideration. For example, according to [1], for any Morse-Smale 3-diffeomorphism, the characteristic space of orbits constructed for the set Σ of saddle points with a one-dimensional unstable manifold is connected. This fact played a key role in obtaining a complete topological classification of such diffeomorphisms, obtained in [1]. According to [13], any Morse-Smale diffeomorphism defined on a manifold of dimension $n > 3$ also has a connected characteristic space of orbits. For orientation-preserving gradient-like (without heteroclinic points) diffeomorphisms on surfaces there is a result in the work [6] that the existence of a connected characteristic orbit space \hat{V}_Σ homeomorphic to the two-dimensional torus \mathbb{T}^2 .

The main result of the work is the proof of the fact that the violation of at least one of the conditions (absence of heteroclinic points, orientability of the surface, orientability of the diffeomorphism) leads to the existence of Morse-Smale diffeomorphisms on the surface that do not have a connected characteristic space of orbits. Exactly, the following theorem is proved.

Theorem 1.

1. *On any orientable surface M^2 there exists an orientation-changing gradient-like diffeomorphism that does not have a connected characteristic space of orbits.*
2. *On any non-orientable surface M^2 there exists a gradient-like diffeomorphism that does not have a connected characteristic space of orbits.*
3. *On any surface M^2 there exists a Morse-Smale diffeomorphism with heteroclinic points that does not have a connected characteristic space of orbits.*

Acknowledgment: The work was supported by the Russian Science Foundation, project no. 17-11-01041, except for section 3, supported by Laboratory of Dynamical Systems and Applications NRU HSE, grant of the Ministry of science and higher education of the RF, ag. № 075-15-2022-1101

2 Required information and facts

Let M^n be a smooth closed orientable manifold and f a diffeomorphism on M^n . For a diffeomorphism f , a point $x \in X$ is called *wandering* if there exists an open neighborhood U_x of x such that $f(U_x) \cap U_x = \emptyset$. Otherwise, the point x is called *non-wandering*. It

is immediate from the definition that any point in the neighborhood U_x of a wandering point x is wandering itself and therefore the set of wandering points is open while the set of non-wandering points is closed.

The set of all nonwandering points of the diffeomorphism f is called the *non-wandering set* and usually denoted by Ω_f .

The simplest examples of hyperbolic sets are primarily the hyperbolic fixed points of a diffeomorphism, which can be classified as follows. Let $f : X \rightarrow X$ be a diffeomorphism and $f(p) = p$. A point p is *hyperbolic* if and only if the absolute value of each eigenvalue of the Jacobi matrix $\left(\frac{\partial f}{\partial x}\right)|_p$ is not equal to 1. If the absolute values of all the eigenvalues are less than 1, then p is called a *attracting (a sink point, or sink)*; if the absolute values of all the eigenvalues are greater than 1 then p is called a *repelling (a source point, or source)*. Attracting or repelling points are called a *nodes*. A hyperbolic fixed point that is not a *node* is called a *saddle point or saddle*.

If the point p is a periodic point f with period $per(p)$, then applying the previous construction to the diffeomorphism $f^{per(p)}$, we obtain a classification of hyperbolic periodic points similar to the classification of fixed hyperbolic points .

The hyperbolic structure of a periodic point p leads to its *stable* $W_p^s = \{x \in M^n : \lim_{k \rightarrow +\infty} d(f^{kper(p)}(x), p) \rightarrow 0\}$ and *unstable* $W_p^u = \{x \in M^n : \lim_{k \rightarrow +\infty} d(f^{-kper(p)}(x), p) \rightarrow 0\}$ diversities that are smooth embeddings of \mathbb{R}^{n-q_p} and \mathbb{R}^{q_p} respectively. Here q_p is the number of eigenvalues of the Jacobian matrix $\left(\frac{\partial f^{per(p)}}{\partial x}\right)|_p$ modulo greater than 1.

For a hyperbolic fixed or periodic point p , the stable or unstable manifold is called the *invariant manifold* of this point, the connected component of the set $W_p^u \setminus p$ ($W_p^s \setminus p$) is called unstable (stable) *separatrix*.

A closed f -invariant set $A \subset M^n$ is called an *attractor* of a discrete dynamical system f if it has a compact neighborhood U_A such that $f(U_A) \subset \text{int } U_A$ and $A = \bigcap_{k \geq 0} f^k(U_A)$. The neighborhood of U_A is called *captivating or isolating*. *Repeller* is defined as an attractor for f^{-1} . An attractor and a repeller are called *dual* if the complement to the exciting neighborhood of the attractor is the exciting neighborhood of the repeller.

A diffeomorphism $f : M^n \rightarrow M^n$ is called a *Morse-Smale diffeomorphism* if

- 1) the nonwandering set Ω_f consists of a finite number of hyperbolic orbits;
- 2) the manifolds W_p^s, W_q^u intersect transversally for any nonwandering points p, q .

A Morse-Smale diffeomorphism is called *gradient-like* if the condition $W_{\sigma_1}^s \cap W_{\sigma_2}^u \neq \emptyset$ for different points $\sigma_1, \sigma_2 \in \Omega_f$ implies that $\dim W_{\sigma_1}^u < \dim W_{\sigma_2}^u$. In dimension $n = 2$, the set of gradient-like diffeomorphisms coincides with the set of Morse-Smale diffeomorphisms whose saddle separatrices do not intersect.

If M^n is an orientable manifold, then the diffeomorphism $f : M^n \rightarrow M^n$ is called *orientation-preserving*, if f has a positive Jacobian at least at one point, otherwise the diffeomorphism is called *orientation-changing*.

Let $f : M^2 \rightarrow M^2$ be a gradient-like diffeomorphism defined on a closed surface M^2 . Let

ω be the sink point of the period m_ω of the diffeomorphism f . According to [5, Theorem 5.5], the diffeomorphism f^{m_ω} in some neighborhood of the point ω is topologically conjugate to the linear diffeomorphism of the plane given by the matrix $\begin{pmatrix} \frac{1}{2} & 0 \\ 0 & \varsigma_\omega \cdot \frac{1}{2} \end{pmatrix}$, where $\varsigma_\omega = +1$ (-1) if $f^{m_\omega}|_{W_\omega^s}$ preserves (changes) orientation. We say that the sink ω has a *positive orientation type* if $\varsigma_\omega = +1$ and has a *negative orientation type* otherwise.

Denote by \mathcal{O}_ω the orbit of the point ω . Let $V_\omega = W_{\mathcal{O}_\omega}^s \setminus \mathcal{O}_\omega$. Denote by $\hat{V}_\omega = V_\omega/f$ the orbit space of the action of the group $F = \{f^k, k \in \mathbb{Z}\} \cong \mathbb{Z}$ on V_ω and by $p_\omega : V_\omega \rightarrow \hat{V}_\omega$ the natural projection.

Proposition 2.1 ([11], Утверждение 1). *The manifold \hat{V}_ω is diffeomorphic to a two-dimensional torus if $\varsigma_\omega = +1$ and is diffeomorphic to a Klein bottle if $\varsigma_\omega = -1$. Moreover, $\eta_\omega(\pi_1(\hat{V}_\omega)) = m_\omega \mathbb{Z}$.*

Similarly denote the orientation type ς_α for the periodic source α of the diffeomorphism f , the space of orbits \hat{V}_α and the projection of the stable separatrix of the saddle point into it.

Let σ be a saddle point of the period m_σ of the diffeomorphism f . According to [5, Theorem 5.5], the diffeomorphism f^{m_σ} in some neighborhood of the point σ is topologically conjugate to the linear diffeomorphism of the plane given by the matrix $\begin{pmatrix} \nu_\sigma \cdot \frac{1}{2} & 0 \\ 0 & \lambda_\sigma \cdot 2 \end{pmatrix}$, where $\nu_\sigma = +1$ (-1) if $f|_{W_\sigma^s}$ preserves (changes) orientation; $\lambda_\sigma = +1$ (-1) if $f|_{W_\sigma^u}$ preserves (changes) orientation. A pair $\varsigma_\sigma = (\nu_\sigma, \lambda_\sigma)$ will be called the *orientation type* of the saddle point σ and denote by $a_{\varsigma_\sigma} : \mathbb{R}^2 \rightarrow \mathbb{R}^2$ a corresponding linear diffeomorphism. If $\nu_\sigma > 0$, $\lambda_\sigma > 0$, then the type of orientation will be called *positive*, and *negative* otherwise.

Denote by \mathcal{O}_σ the orbit of the saddle point σ and set $N_\sigma^u = N_{\mathcal{O}_\sigma} \setminus W_{\mathcal{O}_\sigma}^s$. Then the group F acts on N_σ^u , generating the orbit space $\hat{N}_\sigma^u = N_\sigma^u/f$ and the natural projection $p_\sigma^u : N_\sigma^u \rightarrow \hat{N}_\sigma^u$ (see Figure 1 for the case $\varsigma_\sigma = (+1, +1)$).

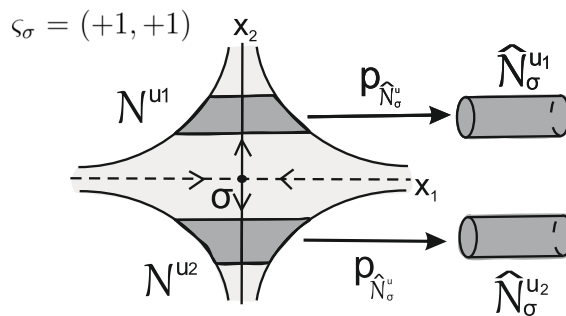

Figure 1: An orbit space \hat{N}_σ^u

Denote similarly by the orbit space $\hat{N}_\sigma^s = N_\sigma^s/f$ of the action of the group F on $N_\sigma^s = N_{\mathcal{O}_\sigma} \setminus W_{\mathcal{O}_\sigma}^u$, the natural projection $p_\sigma^s : N_\sigma^s \rightarrow \hat{N}_\sigma^s$ and mapping η_σ^s composed of homomorphisms into the group \mathbb{Z} from the fundamental group of each connected component of the space \hat{N}_σ^s .

In addition, the map

$$\hat{\psi}_\sigma = p_\sigma^s(p_\sigma^u)^{-1} : \partial\hat{N}_\sigma^u \rightarrow \partial\hat{N}_\sigma^s$$

is well defined and it will be called the *rearrangement map* (see Figure 2 for the case $\varsigma_\sigma = (+1, +1)$).

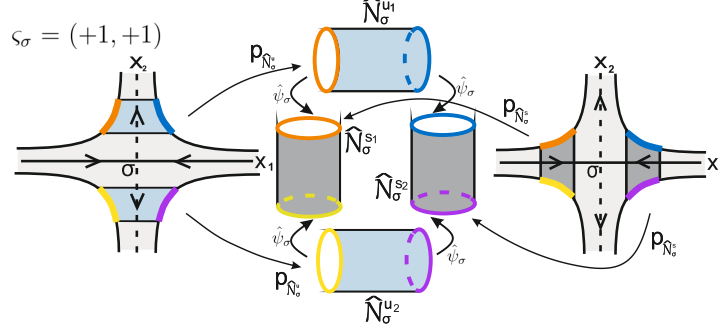

Figure 2: Rearrangement map

Denote by $\Omega_f^0, \Omega_f^1, \Omega_f^2$ the set of sinks, saddles, and sources of the diffeomorphism f . For any (possibly empty) f -invariant set $\Sigma \subset \Omega_f^1$ such that $cl(W_\Sigma^u) \setminus W_\Sigma^u \subset \Omega_f^0$, we set

$$A_\Sigma = \Omega_f^0 \cup W_\Sigma^u, R_\Sigma = \Omega_f^2 \cup W_{\Omega_f^1 \setminus \Sigma}^s.$$

The set

$$V_\Sigma = M^2 \setminus (A_\Sigma \cup R_\Sigma)$$

is called the *characteristic space*. The factor space

$$\hat{V}_\Sigma = V_\Sigma / f$$

is called the *characteristic space of orbits*. Let $V_\Sigma^1 = p_\Sigma^{-1}(\hat{V}_\Sigma^1), \dots, V_\Sigma^k = p_\Sigma^{-1}(\hat{V}_\Sigma^k)$ and denote by m_1, \dots, m_k the number of connected components in the sets $V_\Sigma^1, \dots, V_\Sigma^k$ respectively.

Proposition 2.2 ([7], Proposition 1). *Each connected component of the characteristic orbit space \hat{V}_Σ is homeomorphic either to a two-dimensional torus or to a Klein bottle.*

Proposition 2.3 ([4] Lemma 4.1). *Let $\Sigma' = \Sigma \cup \mathcal{O}_\sigma$ for some saddle orbit \mathcal{O}_σ and \hat{v}, \hat{v}' be the disjoint union of the connected components of the spaces $\hat{V}_\Sigma, \hat{V}_{\Sigma'}$ which have non-empty intersection with $\hat{N}_\sigma^u, \hat{N}_\sigma^s$, respectively. Then*

$$\hat{V}_{\Sigma'} \cong (\hat{V}_\Sigma \setminus \text{int } \hat{N}_\sigma^u) \cup_{\hat{\psi}_\sigma} \hat{N}_\sigma^s.$$

Wherein

$$\hat{V}_{\Sigma'} \cong (\hat{V}_\Sigma \setminus \hat{v}) \sqcup \hat{v}' \tag{1}$$

Corollary 2.1. *If σ is a saddle point with a positive orientation $\varsigma_\sigma = (+1, +1)$, then for the sets \hat{v}, \hat{v}' in the formula (1) the following features are implemented:*

- \hat{v} – a disjoint union of two Klein bottles, \hat{v}' – a disjoint union of two Klein bottles (see Figure 3(1));
- \hat{v} – a torus, \hat{v}' – a disjoint union of two tori (see Figure 3(2));
- \hat{v} – a disjoint union of two tori and \hat{v}' – a torus;
- \hat{v} – a disjoint union of a torus and a Klein bottle and \hat{v}' – a Klein bottle;
- \hat{v} – a Klein bottle and \hat{v}' – a disjoint union of a torus and a Klein bottle;
- \hat{v} – a torus and \hat{v}' – a torus (if M^2 -nonorientable surface).

If σ is a saddle point with negative orientation $\varsigma_\sigma = (-1, -1)$, then the following possibilities are realized:

- \hat{v} – a Klein bottle and \hat{v}' – a Klein bottle;
- \hat{v} – a torus and \hat{v}' – a torus.

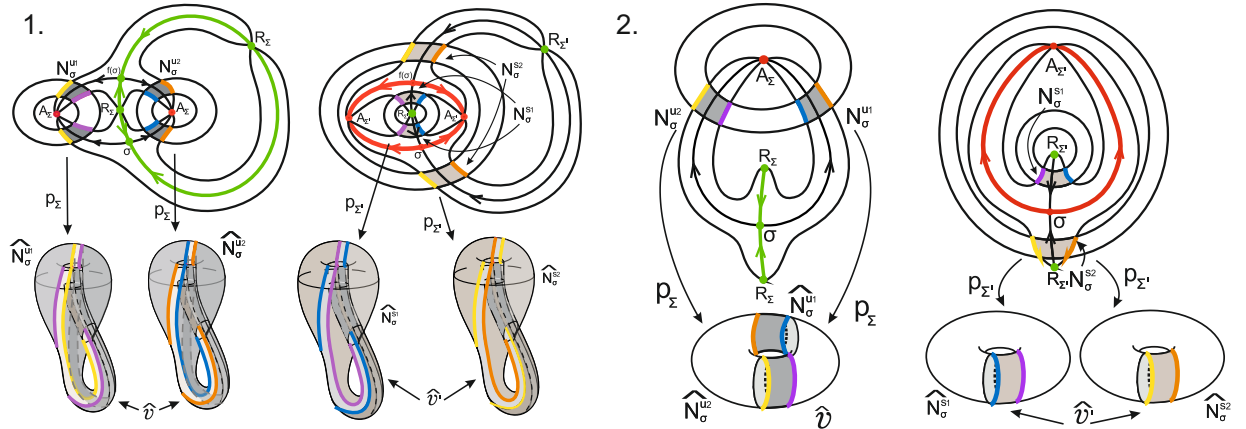

Figure 3: Illustration for the collary 2.1

3 Construction of model diffeomorphisms

In this section, we construct several basic diffeomorphisms, the proof of the theorem 1 will be based on them.

3.1 Gradient-like diffeomorphism ψ_0 on the sphere S^2

Define polar coordinates (r, φ) on the plane \mathbb{R}^2 . Denote by $\varrho(r)$ the function depicted on the graph(see Figure 4), which has the property $\varrho(r) = \varrho(\frac{1}{r})$. Also define a vector field

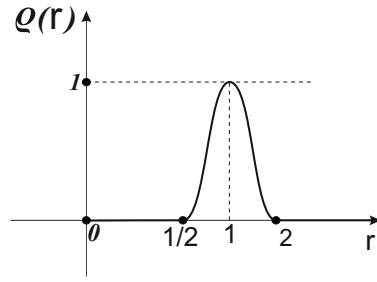

Figure 4: Function graph q .

on the plane \mathbb{R}^2 using the following system of differential equations:

$$\begin{cases} \dot{r} = \begin{cases} -r(r-1), & 0 \leq r \leq 1; \\ 1-r, & r > 1; \end{cases} \\ \dot{\varphi} = q(r) \sin 2\varphi. \end{cases}$$

Denote by χ^t the flow induced by this vector field, and denote by χ^t the diffeomorphism, which is the shift of the flow χ^t per unit of time. The result is a diffeomorphism that has a hyperbolic source at the origin O , hyperbolic saddles at points A_1, A_3 and hyperbolic drains at points A_0, A_2 (see Figure 5) .

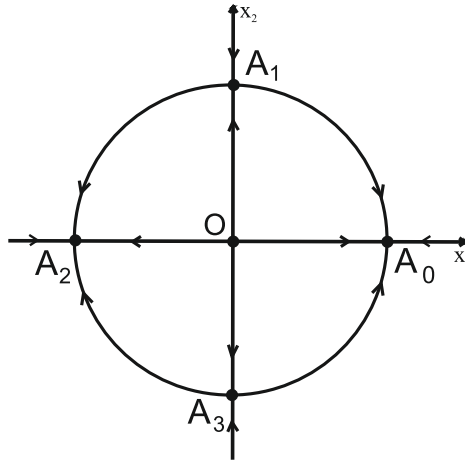

Figure 5: Phase portrait of a diffeomorphism χ

Let a diffeomorphism $\theta : \mathbb{R}^2 \rightarrow \mathbb{R}^2$ be as follows as $\theta(r, \varphi) = (r, -\varphi)$. We define the diffeomorphism $\bar{\psi}_0 : \mathbb{R}^2 \rightarrow \mathbb{R}^2$ by the formula

$$\bar{\psi}_0 = \theta \circ \chi.$$

By the construction, the nonwandering set of the diffeomorphism $\bar{\psi}_0$ coincides with a non-wandering diffeomorphism set χ . Consider the standard two-dimensional sphere

$$\mathbb{S}^2 = \{(x_1, x_2, x_3) \in \mathbb{R}^3 : x_1^2 + x_2^2 + x_3^2 = 1\}.$$

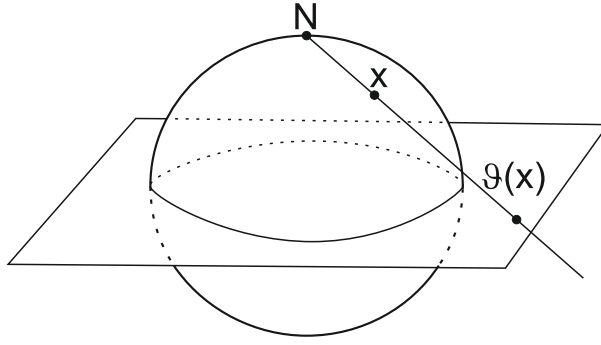

Figure 6: Stereographic projection

Denote by $N(0, 0, 1)$ north pole and define a stereographic projection (see Figure 6) $\vartheta : \mathbb{S}^2 \setminus \{N\} \rightarrow \mathbb{R}^2$ formula

$$\vartheta(x_1, x_2, x_3) = \left(\frac{x_1}{1 - x_3}, \frac{x_2}{1 - x_3} \right).$$

Define a diffeomorphism $\psi_0 : \mathbb{S}^2 \rightarrow \mathbb{S}^2$ by the formula

$$\psi_0(x) = \begin{cases} \vartheta^{-1} \circ \bar{\psi}_0 \circ \vartheta(x), & x \in \mathbb{S}^2 \setminus \{N\}, \\ N, & x = N. \end{cases}$$

By construction, ψ_0 is an orientation-changing gradient-like 2-sphere diffeomorphism whose nonwandering set consists of two fixed sources $\alpha_1 = N$, $\alpha_2 = \vartheta^{-1}(O)$ of negative orientation ($\varsigma_{\alpha_1} = \varsigma_{\alpha_2} = -1$); two fixed sinks $\omega_0 = \vartheta^{-1}(A_0)$, $\omega_1 = \vartheta^{-1}(A_2)$ of negative orientation ($\varsigma_{\omega_0} = \varsigma_{\omega_1} = -1$) and saddle orbit $\mathcal{O}_\sigma = \{\sigma = \vartheta^{-1}(A_1), \psi_0(\sigma) = \vartheta^{-1}(A_3)\}$ of period 2 with orientation type $\varsigma_\sigma = (+1, +1)$ (see Figure 7):

$$\Omega_{\psi_0} = \{\alpha_1, \alpha_2, \omega_0, \omega_1, \sigma, \psi_0(\sigma)\}.$$

3.2 Gradient-like diffeomorphism $\tilde{\psi}_1$ on the projective plane $\mathbb{R}P^2$

Consider the diffeomorphism $\psi_0 : \mathbb{S}^2 \rightarrow \mathbb{S}^2$ defined in 3.1 and the group $\mathbb{Z}_2 = \{+1, -1\}$ acting on the two-dimensional sphere $\mathbb{S}^2 = \{(x_1, x_2, x_3) \in \mathbb{R}^3 : x_1^2 + x_2^2 + x_3^2 = 1\}$ as follows:

$$\pm 1 \cdot x = \pm x, \quad x = (x_1, x_2, x_3) \in \mathbb{S}^2.$$

Then the orbit space $\mathbb{S}^2/\mathbb{Z}_2$ of the action of the group \mathbb{Z}_2 on \mathbb{S}^2 is the projective plane $\mathbb{R}P^2$. Let $p : \mathbb{S}^2 \rightarrow \mathbb{R}P^2$ be the natural projection. Let the diffeomorphism $\tilde{\psi}_1 : \mathbb{R}P^2 \rightarrow \mathbb{R}P^2$ be defined by the formula

$$\tilde{\psi}_1(x) = p \circ \psi_0 \circ p^{-1}(x), \quad x \in \mathbb{R}P^2.$$

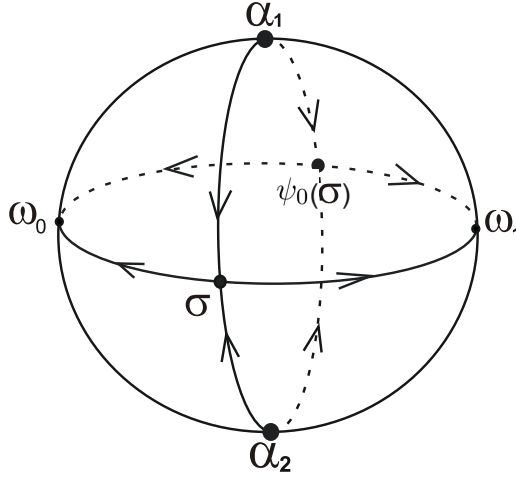

Figure 7: Diffeomorphism ψ_0

By construction, the nonwandering set of the constructed diffeomorphism consists of three fixed points: the source $\tilde{\alpha}$ of negative orientation ($\varsigma_{\tilde{\alpha}} = -1$), the sink $\tilde{\omega}$ of negative orientation ($\varsigma_{\tilde{\omega}} = -1$) and saddle $\tilde{\sigma}_1$ with orientation type $\varsigma_{\tilde{\sigma}_1} = (-1, -1)$ (see Figure 8):

$$\Omega_{\tilde{\psi}_1} = \{\tilde{\alpha}, \tilde{\omega}, \tilde{\sigma}_1\}.$$

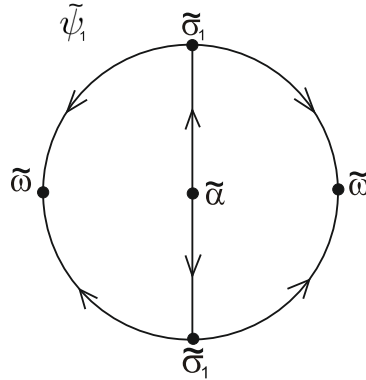

Figure 8: Diffeomorphism $\tilde{\psi}_1$

3.3 Gradient-like diffeomorphism $\tilde{\psi}_q$ on a non-orientable surface of genus q

Let $S_q^- = \mathbb{S}^2 \# \underbrace{\mathbb{R}P^2 \# \dots \# \mathbb{R}P^2}_q$. Construct a model diffeomorphism $\tilde{\psi}_q : S_q^- \rightarrow S_q^-$. The source $\tilde{\alpha}$ and the sink $\tilde{\omega}$ of the diffeomorphism $\tilde{\psi}_1$ should be considered. Whereas they are hyperbolic, there are non-intersecting 2-discs around them $B_{\tilde{\omega}}, B_{\tilde{\alpha}}$, что $\tilde{\psi}_1(B_{\tilde{\omega}}) \subset \text{int } B_{\tilde{\omega}}, \tilde{\psi}_1^{-1}(B_{\tilde{\alpha}}) \subset \text{int } B_{\tilde{\alpha}}$. Then the connected sum of two copies of projective planes along the disks $B_{\tilde{\omega}}, B_{\tilde{\alpha}}$ is a non-orientable surface S_2^- of genus 2 (see Figure 9). Since the

dynamics in the disk $B_{\tilde{\omega}}$ is inverse to the dynamics in the disk $B_{\tilde{\alpha}}$, a diffeomorphism $\tilde{\psi}_2$ is well defined on the surface S_2^- , which coincides with $\tilde{\psi}_1$ to $\mathbb{RP}^2 \setminus B_{\tilde{\alpha}}$ and to $\mathbb{RP}^2 \setminus B_{\tilde{\omega}}$. We say that the diffeomorphism $\tilde{\psi}_2$ is the *connected sum* of two copies of the diffeomorphism $\tilde{\psi}_1$ ($\tilde{\psi}_2 = \tilde{\psi}_1 \# \tilde{\psi}_1$) along the sink $\tilde{\omega}$ and source $\tilde{\alpha}$.

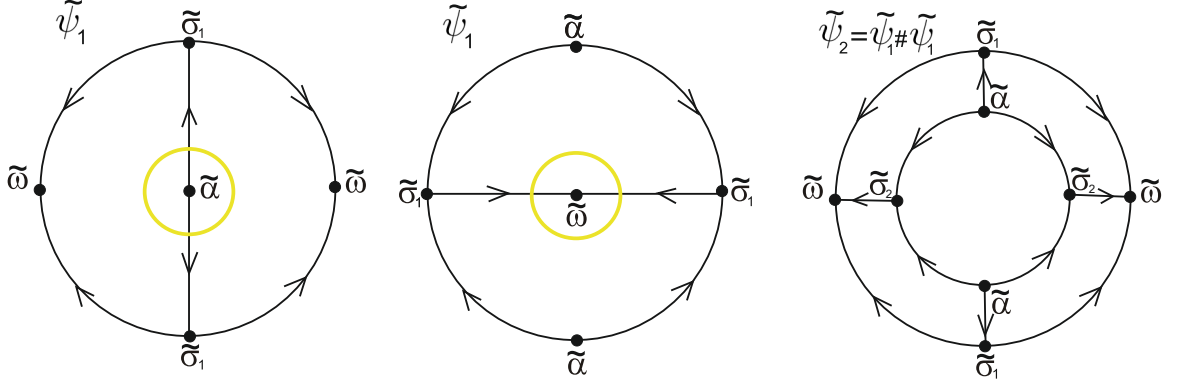

Figure 9: Diffeomorphism $\tilde{\psi}_2$

By induction, a diffeomorphism $\tilde{\psi}_q : S_q^- \rightarrow S_q^-$ on a nonorientable surface of genus $q \geq 2$ is constructed as a connected sum of diffeomorphisms $\tilde{\psi}_{q-1}$ and $\tilde{\psi}_1$ ($\tilde{\psi}_q = \tilde{\psi}_{q-1} \# \tilde{\psi}_1$) along the $\tilde{\omega}$ sink and $\tilde{\alpha}$ source. By construction, the nonwandering set of the diffeomorphism $\tilde{\psi}_q$ consists of $q + 2$ fixed points: the source $\tilde{\alpha}$ of negative orientation ($\varsigma_{\tilde{\alpha}} = -1$), the sink $\tilde{\omega}$ negative orientation ($\varsigma_{\tilde{\omega}} = -1$) and q saddles $\tilde{\sigma}_1, \dots, \tilde{\sigma}_q$ with orientation type $\varsigma_{\tilde{\sigma}_i} = (+1, +1)$ (see Figure 9 for $q = 2$):

$$\Omega_{\tilde{\psi}_q} = \{\tilde{\alpha}, \tilde{\omega}, \tilde{\sigma}_1, \dots, \tilde{\sigma}_q\}.$$

3.4 Gradient-like diffeomorphism ψ_1 on a torus \mathbb{T}^2

We construct a diffeomorphism ψ_1 on the two-dimensional torus \mathbb{T}^2 as a cartesian product of two orientation-preserving source-sink diffeomorphisms on the circle \mathbb{S}^1 . For this we should consider the function $\bar{F} : \mathbb{R} \rightarrow \mathbb{R}$ given by the formula:

$$\bar{F}(x) = x + \frac{1}{6\pi} \sin 2\pi x$$

(see Figure 10).

Consider the projection $\pi : \mathbb{R} \rightarrow \mathbb{S}^1$ given by the formula $\pi(x) = e^{2\pi i x}$. Since the function \bar{F} is strictly monotonically increasing and satisfies the condition $\bar{F}(x + 1) = \bar{F}(x) + 1$, it admits a projection onto a circle in diffeomorphism $F : \mathbb{S}^1 \rightarrow \mathbb{S}^1$ given by

$$F(z) = \pi \bar{F} \pi^{-1}(z), \quad z \in \mathbb{S}^1.$$

By construction, the diffeomorphism F has a fixed hyperbolic sink and source and is an orientation-preserving source-sink diffeomorphism. Define a diffeomorphism $F_1 : \mathbb{T}^2 \rightarrow \mathbb{T}^2$

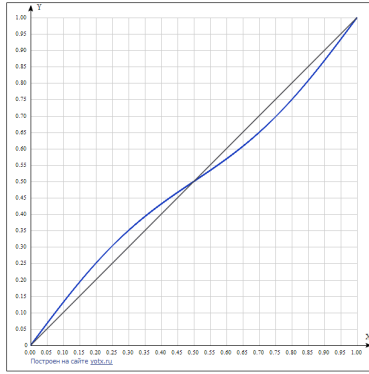

Figure 10: Function Graph \bar{F}

by the formula

$$F_1(z, w) = (F(z), F(w)), \quad z, w \in \mathbb{S}^1.$$

Then the diffeomorphism F_1 is orientation-preserving, and its nonwandering set consists of four fixed points: a source α of positive orientation ($\varsigma_\alpha = +1$), a sink ω of positive orientation ($\varsigma_\omega = +1$) and two saddles σ_1, σ_2 of positive orientation type (see Figure 11):

$$\Omega_{F_1} = \{\alpha, \omega, \sigma_1, \sigma_2\}.$$

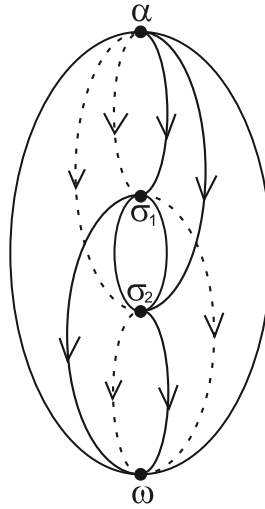

Figure 11: Diffeomorphism F_1

Let us represent the two-dimensional torus \mathbb{T}^2 as the factor group of the group \mathbb{R}^2 with respect to the integer lattice \mathbb{Z}^2 : $\mathbb{T}^2 = \mathbb{R}^2/\mathbb{Z}^2$. Consider the matrix $A = \begin{pmatrix} 0 & 1 \\ 1 & 0 \end{pmatrix} \in GL(2, \mathbb{Z})$ and the algebraic torus automorphism $\hat{A}: \mathbb{T}^2 \rightarrow \mathbb{T}^2$,

$$\hat{A}(x, y) = (y, x) \pmod{1}$$

Let

$$\psi_1 = \hat{A} \circ F_1 : \mathbb{T}^2 \rightarrow \mathbb{T}^2.$$

By construction, the diffeomorphism ψ_1 is an orientation-changing gradient-like diffeomorphism whose nonwandering set consists of a source α and a sink ω of negative orientation types ($\varsigma_\alpha = \varsigma_\omega = -1$), as well as periodic saddle orbit $\mathcal{O}_{\sigma_1} = \{\sigma_1, \psi_1(\sigma_1)\}$ of period 2 and orientation type $\varsigma_{\sigma_1} = (+1, +1)$ (see Figure 12):

$$\Omega_{\psi_1} = \{\alpha, \omega, \sigma_1, \psi_1(\sigma_1)\}.$$

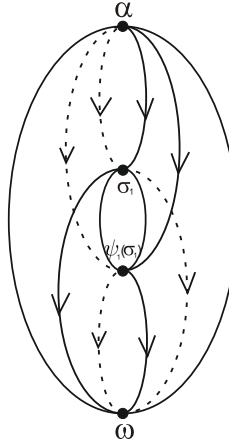

Figure 12: Diffeomorphism ψ_1

3.5 Gradient-like diffeomorphism ψ_g on an orientable surface of genus g

Let $S_g^+ = \mathbb{S}^2 \# \underbrace{\mathbb{T}^2 \# \dots \# \mathbb{T}^2}_g$. Let us construct a model diffeomorphism $\psi_g : S_g^+ \rightarrow S_g^+$. To

do this, firstly, we should construct a diffeomorphism $\psi_2 : S_2^+ \rightarrow S_2^+$ as a connected sum of two copies of the diffeomorphism ψ_1 ($\psi_2 = \psi_1 \# \psi_1$) along the sink ω and the source α (see Fig. 13). Then, by induction, we define the diffeomorphism $\psi_g : S_g^+ \rightarrow S_g^+$ as a connected sum of diffeomorphisms ψ_{g-1} and ψ_1 ($\psi_g = \psi_{g-1} \# \psi_1$) along the sink ω and the source α . By construction, the nonwandering set of the diffeomorphism ψ_g consists of a fixed source α and a fixed sink ω of negative orientation types ($\varsigma_\alpha = \varsigma_\omega = -1$), and g saddle periodic orbits $\mathcal{O}_{\sigma_1} = \{\sigma_1, \psi_1(\sigma_1)\}, \dots, \mathcal{O}_{\sigma_g} = \{\sigma_g, \psi_1(\sigma_g)\}$ of period 2 and orientation type $\varsigma_{\sigma_i} = (+1, +1)$ (see Figure 13 for $g = 2$):

$$\Omega_{\psi_g} = \{\alpha, \omega, \sigma_1, \psi_g(\sigma_1), \dots, \sigma_g, \psi_g(\sigma_g)\}.$$

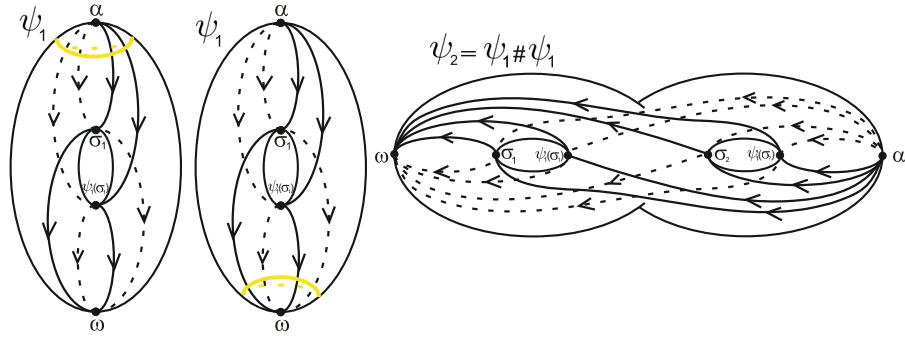

Figure 13: Diffeomorphism ψ_2

3.6 Non-gradient-like Morse-Smale diffeomorphism ξ_0 on the sphere \mathbb{S}^2

Consider the diffeomorphism $h : \mathbb{R}^2 \rightarrow \mathbb{R}^2$ given in polar coordinates (r, φ) , $\varphi \in (-\frac{\pi}{2}, \frac{3\pi}{2}]$ by the formula $h(r, \varphi) = (\frac{r}{2}, \varphi)$. Let $A_- = \{(r, \varphi) \in \mathbb{R}^2 \setminus \{0\} : \frac{3\pi}{4} \leq \varphi \leq \frac{5\pi}{4}\}$, $A_+ = \{(r, \varphi) \in \mathbb{R}^2 \setminus \{0\} : |\varphi| \leq \frac{\pi}{4}\}$. Let $C = \mathbb{R} \times [-2, 2]$ and define the diffeomorphisms $\eta_- : A_- \rightarrow C$, $\eta_+ : A_+ \rightarrow C$ by the formulas

$$\eta_-(r, \varphi) = \left(3 - \log_2 r, 8 \left(\frac{\varphi}{\pi} - 1\right)\right), \quad \eta_+(r, \varphi) = \left(-3 - \log_2 r, \frac{8\varphi}{\pi}\right).$$

It is directly verified that the diffeomorphism $\eta_- (\eta_+)$ conjugates the diffeomorphism h with the diffeomorphism $g : C \rightarrow C$ defined by the formula $g(x, d) = (x + 1, d)$ and $\eta_-(2, \pi) = (2, 0)$ ($\eta_+(1/2, 0) = (-2, 0)$). It is obvious that the diffeomorphism g is included in the flow $g^t : C \rightarrow C$ defined by the formula

$$g^t(x, d) = (x + t, d).$$

We define the flow ϕ_-^t on C using the formulas

$$\begin{cases} \dot{x} = \begin{cases} 1 - \frac{1}{9}(x^2 + d^2 - 4)^2, & x^2 + d^2 \leq 4 \\ 1, & \text{else} \end{cases} \\ \dot{d} = \begin{cases} \frac{d}{2} \left(\sin\left(\frac{\pi}{2}(x^2 + d^2 - 3)\right) - 1 \right), & 2 < x^2 + d^2 \leq 4 \\ -d, & x^2 + d^2 \leq 2 \\ 0, & \text{else} \end{cases} \end{cases}$$

By construction, the flow ϕ_-^t coincides with the flow g^t for $|x| \geq 2$. Moreover, the diffeomorphism $\phi_- = \phi_-^1$ has exactly two fixed points: the saddle $P_-(1, 0)$ and the sink $Q_-(-1, 0)$ (see Figure 14), besides both points are hyperbolic. One unstable separatrix of the P_- saddle is an open interval $(-1, 1) \times \{0\}$ belonging to the Q_- sink basin, and the other is a ray $(1, +\infty) \times \{0\}$.

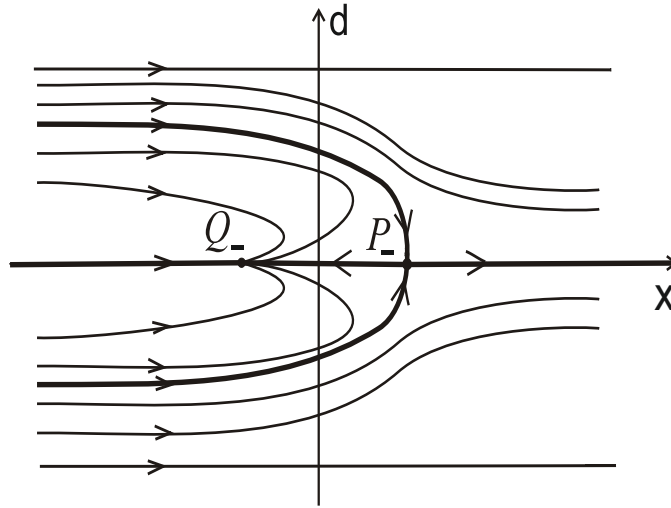

Figure 14: Flow paths ϕ_-^t

Define the flow ϕ_+^t on C by the formulas

$$\begin{cases} \dot{x} = \begin{cases} 1 - \frac{1}{9}(x^2 + d^2 - 4)^2, & x^2 + d^2 \leq 4 \\ 1, & \text{else} \end{cases} \\ \dot{d} = \begin{cases} -\frac{d}{2}(\sin(\frac{\pi}{2}(x^2 + d^2 - 3)) - 1), & 2 < x^2 + d^2 \leq 4 \\ d, & x^2 + d^2 \leq 2 \\ 0, & \text{else} \end{cases} \end{cases}$$

By construction, the flow ϕ_+^t coincides with the flow g^t for $|x| \geq 2$. In this case, the

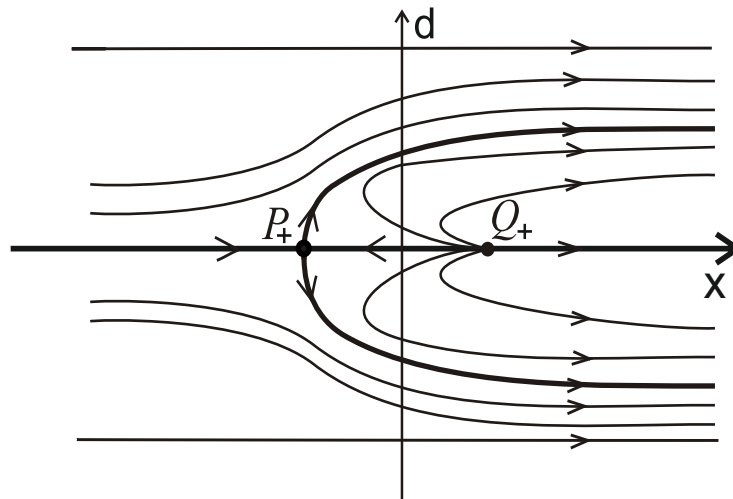

Figure 15: Flow paths ϕ_+^t

diffeomorphism $\phi_+ = \phi_+^1$ has exactly two fixed points: the saddle $P_+(-1.0)$ and the source $Q_+(1.0)$ (see Figure 15), similarly, both points are hyperbolic. One stable separatrix of the saddle P_+ is the open interval $(-1, 1) \times \{0\}$ belonging to the source basin Q_+ , and the other

is the ray $(-\infty, -1) \times \{0\}$.

Define diffeomorphism $\bar{f} : \mathbb{R}^2 \rightarrow \mathbb{R}^2$ so that \bar{f} coincides h outside $A_+ \cup A_-$ and coincides $\eta_-^{-1} \phi_- \eta_-$ and $\eta_+^{-1} \phi_+ \eta_+$ to A_- and A_+ respectively.

Consider on \mathbb{R}^2 the annulus $K = \{(x_1, x_2) \in \mathbb{R}^2 : 1 \leq x_1^2 + x_2^2 \leq 4\}$. Define the function $\nu : [1, 2] \rightarrow [1, 2]$ (see Figure 17) by the formula:

$$\nu(t) = \begin{cases} 1, & t = 1, \\ 1 + \frac{1}{1 + \exp\left(\frac{1}{(t-1)^2(t-2)^2}\right)}, & 1 < t < 2, \\ 2, & t = 2. \end{cases}$$

On the annulus K we can define the Dehn twist $\bar{d} : K \rightarrow K$ formula

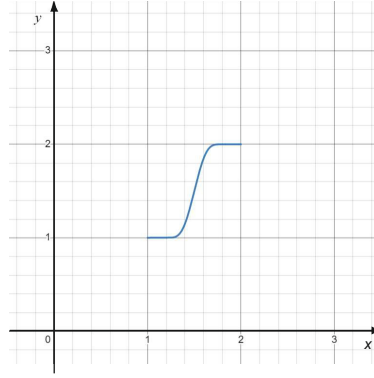

Figure 16: Function Graph $\nu : [1, 2] \rightarrow [1, 2]$

$$\bar{d}(t, e^{i\phi}) = (t, e^{i(\phi + 2\pi\nu(t))}).$$

Let $\bar{\xi}_0 = \bar{d} \circ \bar{f} : \mathbb{R}^2 \rightarrow \mathbb{R}^2$ (see Figure 17).

By construction, the diffeomorphism $\bar{\xi}_0$ coincides with h in some neighborhood of the point O and the point at infinity, therefore, it induces on \mathbb{S}^2 a Morse-Smale diffeomorphism $\xi_0 : \mathbb{S}^2 \rightarrow \mathbb{S}^2$ by the formula

$$\xi_0(x) = \begin{cases} \vartheta^{-1} \circ \bar{\xi}_0 \circ \vartheta(x), & x \in \mathbb{S}^2 \setminus \{N\}, \\ N, & x = N. \end{cases}$$

It follows directly from the construction that the nonwandering set of the diffeomorphism ξ_0 consists of six fixed points of positive orientation: two sources $\alpha_1 = N$, $\alpha_2 = \xi_0(\vartheta^{-1}(Q_+))$, two sinks $\omega_0 = \xi_0(\vartheta^{-1}(Q_-))$, $\omega = S$ and two saddles $\sigma = \xi_0(\vartheta^{-1}(P_-))$, $\sigma_0 = \xi_0(\vartheta^{-1}(P_+))$

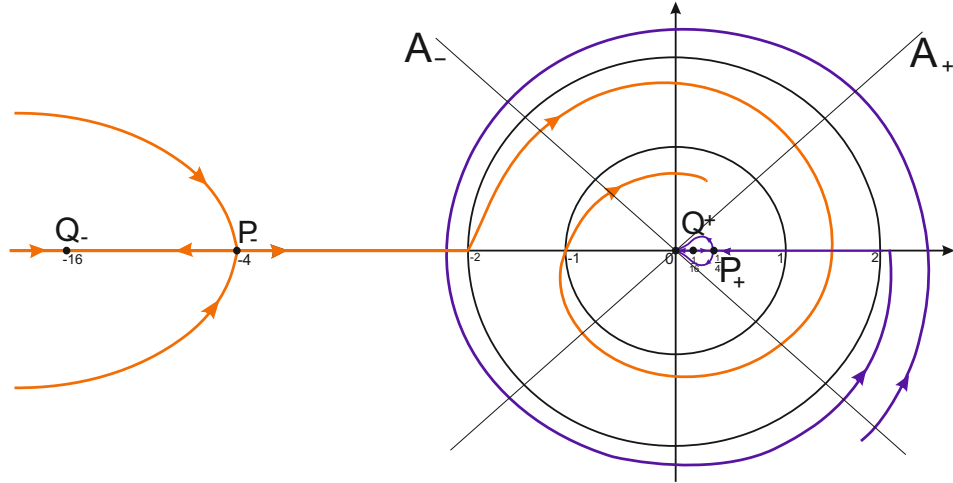

Figure 17: Diffeomorphism $\bar{\xi}_0$

(see Figure 18):

$$\Omega_{\bar{\xi}_0} = \{\alpha_1, \alpha_2, \omega_0, \omega, \sigma_0, \sigma\}.$$

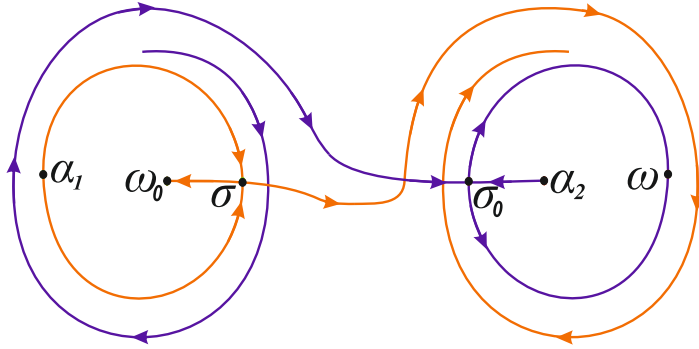

Figure 18: Phase portrait of a diffeomorphism ξ_0

4 Proof of the main result

In this section, we will prove the theorem 1, each item in a separate lemma below.

Lemma 4.1. *On any orientable surface M^2 there exists an orientation-changing gradient-like diffeomorphism that does not have a connected characteristic space of orbits.*

Proof. To prove the lemma, consider a diffeomorphism $f_g : S_g^+ \rightarrow S_g^+$ such that $f_0 = \psi_0$ and f_g ($g > 0$) is the connected sum of the diffeomorphism ψ_0 with the diffeomorphism ψ_g along sink ω_0 and source α respectively. By construction, the diffeomorphism f_g changes orientation, and its nonwandering set consists of two fixed sources α_1, α_2 , two fixed sinks ω, ω_1 of negative orientation ($\varsigma_{\alpha_1} = \varsigma_{\alpha_2} = \varsigma_{\omega} = \varsigma_{\omega_1} = -1$) and $g + 1$ saddle periodic orbits

$\mathcal{O}_\sigma = \{\sigma, f_g(\sigma)\}, \mathcal{O}_{\sigma_1} = \{\sigma_1, f_g(\sigma_1)\}, \dots, \mathcal{O}_{\sigma_g} = \{\sigma_g, f_g(\sigma_g)\}$ of period 2 and orientation type $(+1, +1)$ (see Figure 13):

$$\Omega_{f_g} = \{\alpha, \omega, \sigma, f_g(\sigma_1), \sigma_1, f_g(\sigma_1), \dots, \sigma_g, f_g(\sigma_g)\}.$$

Let us show that the diffeomorphism f_g does not have a connected characteristic space of

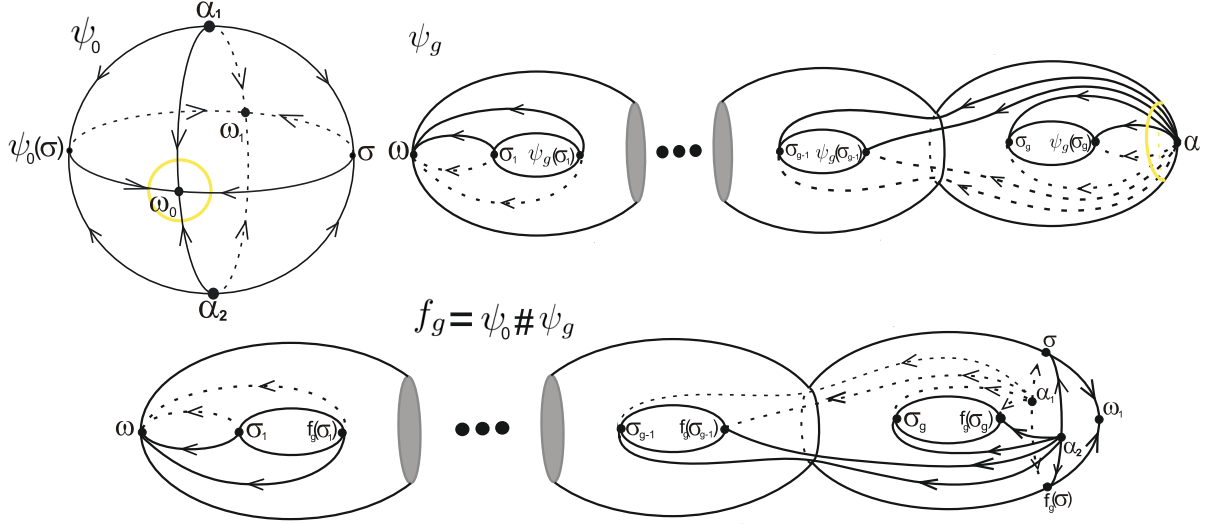

Figure 19: Diffeomorphism f_g

orbits.

Indeed, by the proposition 2.1, each of the orbit spaces $\hat{V}_\omega, \hat{V}_{\omega_1}$ is homeomorphic to a Klein bottle. Therefore, if $\Sigma = \emptyset$, then the characteristic orbit space \hat{V}_Σ is not connected and consists of two Klein bottles. Since all saddle points of the diffeomorphism f_g have a positive orientation type, then, according to the corollary 2.1, adding the orbits of such saddles to the set Σ does not decrease the number of connected components of the characteristic space of orbits. \square

Lemma 4.2. *On any non-orientable surface M^2 there exists a gradient-like diffeomorphism that does not have a connected characteristic space of orbits.*

Proof. Define a diffeomorphism $\tilde{f}_q : S_q^- \rightarrow S_q^-$, $q \in \mathbb{N}$ as a connected sum of diffeomorphisms ψ_0 and $\tilde{\psi}_q$ ($\tilde{f}_q = \psi_0 \# \tilde{\psi}_q$) along the sink ω_0 of the diffeomorphism ψ_0 and the source $\tilde{\alpha}$ of the diffeomorphism $\tilde{\psi}_q$ (see Fig. 20 for $q = 1$). By construction, the nonwandering set $\Omega_{\tilde{f}_q}$ consists of two sources α_1, α_2 and two sinks $\omega_1, \tilde{\omega}$ of negative orientation types ($\varsigma_{\omega_1} = \varsigma_{\tilde{\omega}} = \varsigma_{\alpha_1} = \varsigma_{\alpha_2} = -1$), also of q fixed saddles $\tilde{\sigma}_1, \dots, \tilde{\sigma}_q$ of orientation type $\varsigma_{\tilde{\sigma}_i} = (-1, -1)$ and a saddle orbit $\mathcal{O}_\sigma = \{\sigma, \tilde{f}_q(\sigma)\}$ of period 2 with a positive orientation type (see Figure 20 for $q = 1$):

$$\Omega_{\tilde{f}_q} = \{\alpha_1, \alpha_2, \omega_1, \tilde{\omega}, \sigma, \tilde{f}_q(\sigma_1), \tilde{\sigma}_1, \dots, \tilde{\sigma}_q\}.$$

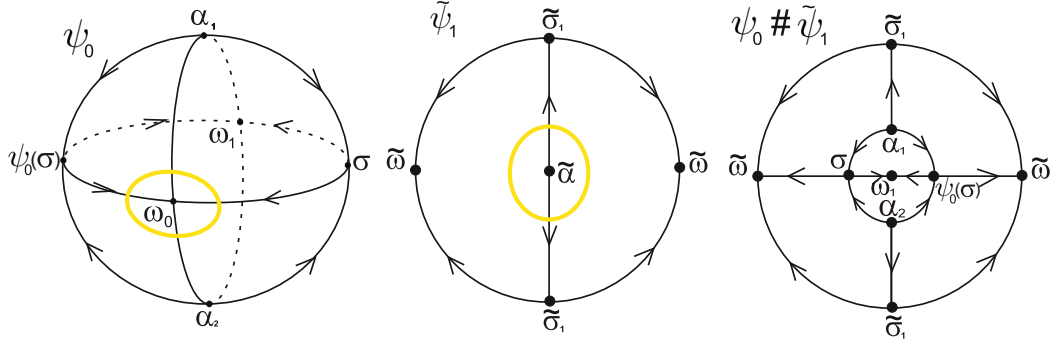

Figure 20: Diffeomorphism \tilde{f}_1

Let us show that the diffeomorphism \tilde{f}_q does not have a connected characteristic space of orbits.

By the construction and proposition 2.1, each of the orbit spaces $\hat{V}_{\tilde{\omega}}$, \hat{V}_{ω_1} is homeomorphic to a Klein bottle. If $\Sigma = \emptyset$, then the characteristic orbit space \hat{V}_{Σ} is not connected and consists of two Klein bottles. Since all saddle points of the diffeomorphism \tilde{f}_q have orientation type either $(+1, +1)$ or $(-1, -1)$, then, according to the corollary 2.1, adding the orbits of such saddles to the set Σ does not decrease the number of connected components of the characteristic space of orbits. \square

Lemma 4.3. *On any surface M^2 there exists a Morse-Smale diffeomorphism with heteroclinic points that does not have a connected characteristic space of orbits.*

Proof. We construct a diffeomorphism $\xi_g : S_g^+ \rightarrow S_g^+$ as a connected sum of diffeomorphisms ξ_0 and ψ_g^2 ($\xi_g = \xi_0 \# \psi_g^2$) along the sink ω_0 of the diffeomorphism ξ_0 and the source α of the diffeomorphism ψ_g^2 . By construction, the diffeomorphism ξ_g preserves orientation, its nonwandering set consists of points of positive orientation type: two sinks ω, ω_1 and two sources α_1, α_2 and $2 + 2g$ saddles $\sigma_0, \sigma, \sigma_1, \dots, \sigma_{2g}$ (a special case for $g = 1$ is shown in Figure 21).

Let us show that the diffeomorphism ξ_g does not have a connected characteristic space of orbits.

Let the set $\Sigma = \emptyset$, then the characteristic orbit space consists of two tori \hat{V}_{ω_1} and \hat{V}_{ω} . Since the unstable saddle point manifolds $\sigma_1, \dots, \sigma_{2g}$ contain the only one sink ω in their closures, then adding these saddles to the set Σ does not reduce the number of components of the characteristic space of orbits. The unstable manifold of the saddle σ_0 contains the only one sink ω_1 in its closure, then adding this saddle to the set Σ increases the number of connected components of the characteristic space to three. The saddle σ is above the saddle σ_0 by the Smale order, so the saddle σ can be added to the set Σ only together with the saddle σ_0 . Whence it follows that for any set Σ the number of connected components of the characteristic space is greater than one.

Also, let us construct a diffeomorphism $\tilde{\xi}_q : S_q^- \rightarrow S_q^-$ as a connected sum of diffeomorphisms ξ_0 and $\tilde{\psi}_q^2$ ($\tilde{\xi}_q = \xi_0 \# \tilde{\psi}_q^2$) along the sink ω_0 of the diffeomorphism ξ_0 and the

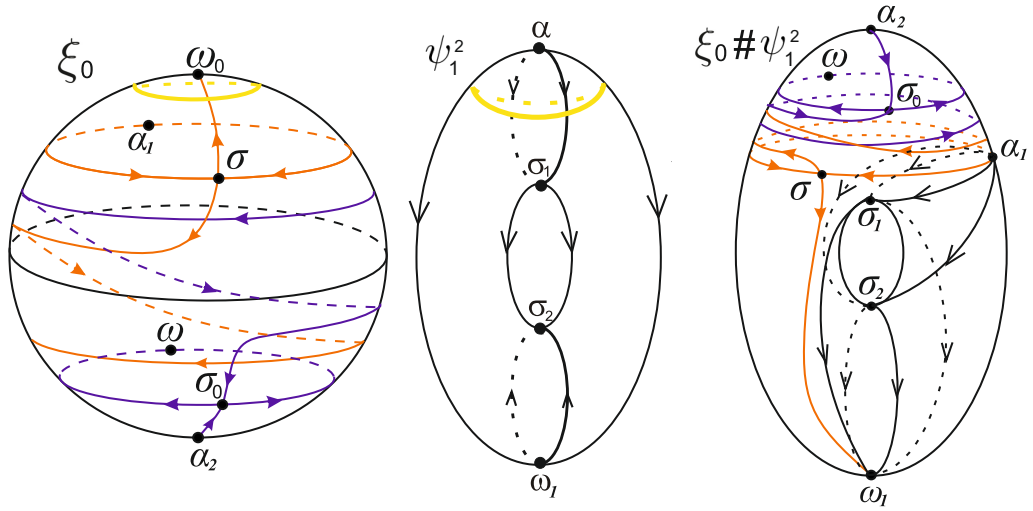

Figure 21: Diffeomorphism ξ_1

source $\tilde{\alpha}$ of the diffeomorphism $\tilde{\psi}_q^2$ (a special case for $q = 1$ is shown in Figure 22). The nonwandering set of the diffeomorphism ζ_q consists of points of positive orientation type: two sources α_1, α_2 , two sinks $\omega_1, \tilde{\omega}$ and $q + 2$ saddles $\sigma, \sigma_0, \tilde{\sigma}_1, \dots, \tilde{\sigma}_q$.

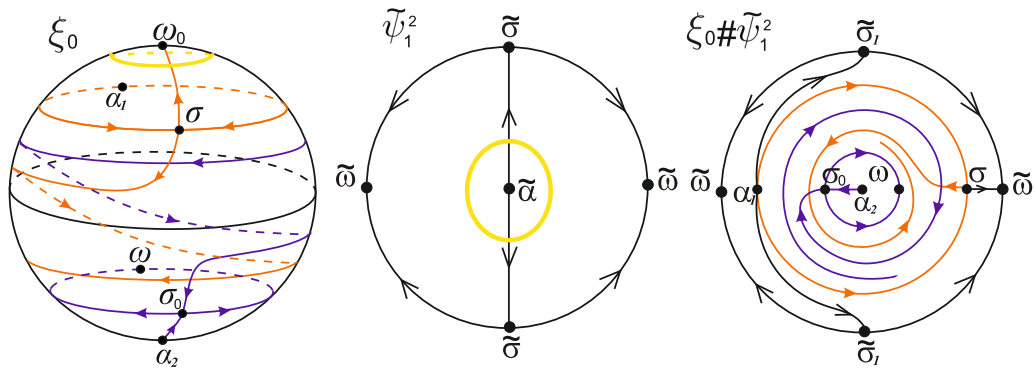

Figure 22: Connected sum of diffeomorphisms ξ_0 and $\tilde{\psi}_1^2$

Similar Arguments to the case of orientable surfaces prove that the diffeomorphism $\tilde{\xi}_q$ does not have a connected characteristic space of orbits.

□

References

- [1] V. Grines C. Bonatti and O. Pochinka. Topological classification of morse–smale diffeomorphisms on 3-manifolds. *Duke Mathematical Journal*, 168(13):2507–2558, 2019.
- [2] V. Medvedev C. Bonatti, V. Grines and E. Pecou. Topological classification of gradient-like diffeomorphisms on 3-manifolds. *Topology*, 43(2):369–391, 2004.

- [3] A. Morozov D. Malyshev and O. Pochinka. Combinatorial invariant for morse–smale diffeomorphisms on surfaces with orientable heteroclinic. *Chaos: An Interdisciplinary Journal of Nonlinear Science*, 31(2):023119, 2021.
- [4] E. Tsaplina E. Nozdrinova, O. Pochinka. A criterion for the existence of a connected characteristic space of orbits for a gradient-like diffeomorphism of a surface. 2022.
- [5] W. de Melo J. Palis. *Geometric Theory of Dynamical Systems*. 1986.
- [6] E. Nozdrinova. Existence of a connected characteristic space for gradient-like diffeomorphisms of surfaces. *Journal of the Middle Volga Mathematical Society*, 19(2):91–97, 2017.
- [7] D. Pixton. Wild unstable manifolds. *Topology*, 16(2):167–172, 1977.
- [8] E. Gurevich V. Grines and O. Pochinka. Topological classification of morse–smale diffeomorphisms without heteroclinic intersections. *Journal of Mathematical Sciences*, 208(1):81–90, 2015.
- [9] E. Zhuzhoma V. Grines, E. Gurevich and O. Pochinka. Classification of morse–smale systems and topological structure of underlying manifolds. *Russian Mathematical Surveys*, 74(1 (445):41–116, 2019.
- [10] O. Pochinka V. Grines, E. Gurevich and D. Malyshev. On topological classification of morse–smale diffeomorphisms on the sphere S^n ($n > 3$). *Nonlinearity*, 33(12):7088, 2020.
- [11] O. Pochinka V. Grines, S. Kapkaeva. A three-colour graph as a complete topological invariant for gradient-like diffeomorphisms of surfaces. *Matematicheskii Sbornik*, 205(10):19–46, 2014.
- [12] T. Medvedev V. Grines and O. Pochinka. *Dynamical systems on 2-and 3-manifolds*, volume 46. Springer, 2016.
- [13] V. Medvedev O. Pochinka V. Grines, E. Zhuzhoma. Global attractor and repeller of morse–smale diffeomorphisms. *Proceedings of the Steklov Institute of Mathematics*, 271(0):111–133, 2010.