

acp

2  
0  
1  
3

The Official Conference  
Proceedings 2013

i  
a  
f  
o  
r

ISSN: 2187-4743





# The Asian Conference on Psychology & the Behavioral Sciences

Osaka Japan 2013

## The Asian Conference on Psychology & the Behavioral Sciences

### Conference Proceedings 2013

**Dr Shamim Ali**

Lecturer,  
National University of Modern Languages, Pakistan

**Professor David N Aspin**

Professor Emeritus and Former Dean of the Faculty of  
Education, Monash University, Australia  
Visiting Fellow, St Edmund's College, Cambridge University,  
UK

**Dr William Baber**

Associate Professor  
Kyoto University Graduate School of Management, Japan

**Professor Don Brash**

Former Governor of the Reserve Bank, New Zealand  
Former Leader of the New National Party, New Zealand  
Adjunct Professor, AUT, New Zealand & La Trobe University,  
Australia

**Lord Charles Bruce of Elgin and Kincardine**

Lord Lieutenant of Fife  
Chairman of the Patrons of the National Galleries of  
Scotland  
Trustee of the Historic Scotland Foundation, UK

**Professor Judith Chapman**

Professor of Education, Australian Catholic University,  
Australia  
Visiting Fellow, St Edmund's College, Cambridge University,  
UK  
Member of the Order of Australia

**Professor Chung-Ying Cheng**

Professor of Philosophy, University of Hawai'i at Manoa, USA  
Editor-in-Chief, The Journal of Chinese Philosophy

**Professor Tien-Hui Chiang**

Professor and Chair, Department of Education  
National University of Tainan, Taiwan/Chinese Taipei

**Mr Marcus Chidgey**

CEO, Captive Minds Communications Group, London, UK

**Professor Kevin Cleary**

President of the Japan Association of Language Teachers  
(JALT)

**Professor Steve Cornwell**

Professor of English and Interdisciplinary Studies  
Osaka Jogakuin University, Osaka, Japan  
Osaka Local Conference Chair

Professor Michael A. Cusumano  
SMR Distinguished Professor of Management and  
Engineering Systems,  
MIT Sloan School of Management  
Massachusetts Institute of Technology, USA

**Professor Dexter Da Silva**

Professor of Educational Psychology  
Keisen University, Tokyo, Japan

**Professor Georges Depeyrot**

Professor and Director of Research  
French National Center for Scientific Research (CNRS)/Ecole  
Normale Supérieure, Paris, France

**Professor Sue Jackson**

Professor of Lifelong Learning and Gender  
Pro-Vice Master of Teaching and Learning  
Birkbeck, University of London, UK

**Professor June Henton**

Dean  
College of Human Sciences  
Auburn University, USA

**Professor Michael Hudson**

President of The Institute for the Study of Long-Term  
Economic Trends (ISLET)  
Distinguished Research Professor of Economics at the  
University of Missouri, Kansas City

**Vice-Consul Kathryn Kiser**

Cultural Affairs Officer, Lahore, Pakistan  
The United States Department of State, USA

**Mr Shahzada Khalid**

Deputy Director  
SAARC Energy Center, Pakistan

**Mrs Eri Kudo**

Head Private Sector Fundraising  
United Nations World Food Programme Japan, Tokyo, Japan

**Professor Sing Kong Lee**

Director  
The National Institute of Education, Singapore

**Dr Woon Chia Liu**

Associate Dean, Practicum and School Partnerships, Teacher  
Education  
The National Institute of Education, Singapore

**Professor Sir Geoffrey Lloyd**

Senior Scholar in Residence, The Needham Research  
Institute, Cambridge, UK  
Fellow and Former Master, Darwin College, University of  
Cambridge  
Fellow of the British Academy  
Honorary Foreign Member, The American Academy of Arts  
and Sciences

**Dr Robert Logie**

Associate Professor of Computer Science  
Osaka Gakuin University, Japan

**Dr David McLoughlin**

Associate Professor  
Meiji University, Japan

**Professor Vasile Meita**

General Manager  
The National Institute for Research and Development in  
Construction, Urban Planning and Sustainable Spatial  
Development (URBAN=INCERC), Romania

**Professor Keith Miller**

Louise Hartman Schewe and Karl Schewe Professor of  
Computer Science  
The University of Illinois Springfield, USA  
Editor-in-Chief, IEEE Technology and Society

**Professor Marjo Hannele Mitsutomi**

Head of English Language Teaching Practices and the  
Language Development Intercultural Studies Center  
Akita International University, Japan

**Professor Ka Ho Joshua Mok**

Chair Professor of Comparative Policy, Associate Vice-  
President (External Relations)  
Dean of the Faculty of Arts and Sciences  
The Hong Kong Institute of Education, Hong Kong SAR



**Dr Jo Mynard**

Associate Professor & Director of the SALC, Kanda University  
of International Studies, Japan

**Professor Michiko Nakano**

Professor of English  
Director of the Distance Learning Center  
Waseda University, Tokyo, Japan

**Ms Karen Newby**

Director  
Par les mots solidaires, Paris, France

**Professor Jerry Platt**

Professor of Business,  
Akita International University, Japan,  
Dean and Professor Emeritus, College of Business, San  
Francisco State, USA

**Professor Michael Pronko**

Professor of American Literature and Culture  
Meiji Gakuin University, Tokyo, Japan

**Professor Richard Roth**

Senior Associate Dean  
Medill School of Journalism, Northwestern University, Qatar

**Professor Monty P. Satiadarma**

Clinical Psychologist and Lecturer in Psychology  
Former Dean of the Department of Psychology and Rector of  
the University  
Tarumanagara University, Indonesia

**Mr Michael Sakamoto**

Interdisciplinary Artist  
UCLA, USA

**Mr Mohamed Salaheen**

Director  
The United Nations World Food Programme, Japan & Korea

**Mr Lowell Sheppard**

Asia Pacific Director  
HOPE International Development Agency, Canada/Japan

**Professor Ken Kawan Soetanto**

Professor and Director of CLEDSI  
Waseda University, Japan

**Dr Jeffrey Sommers**

Associate Professor of Economics, University of Wisconsin-  
Milwaukee, USA  
Visiting Faculty, Stockholm School of Economics, Riga,  
Latvia

**His Excellency Dr Drago Stambuk**

Croatian Ambassador to Brazil  
Brazil

**Professor Mary Stuart**

Vice-Chancellor  
The University of Lincoln, UK

**Professor Gary Swanson**

Distinguished Journalist-in-Residence & Mildred S. Hansen  
Endowed Chair  
The University of Northern Colorado, USA

**Dr David Wilkinson**

Associate Dean (International & External Programmes)  
Faculty of Law and Management  
La Trobe University, Australia

**Professor Kensaku Yoshida**

Professor of English  
Director of the Center for the Teaching of Foreign  
Languages in General Education  
Sophia University, Tokyo, Japan

**Mrs Elly Zaniewicka**

Political Correspondent  
BBC Political Programmes, London, UK

© The International Academic Forum 2013  
The International Academic Forum (IAFOR)  
Sakae 1-16-26-201  
Naka Ward, Nagoya, Aichi  
Japan 460-0008  
ISSN – 2187-4743  
[http://iafor.org/acp\\_proceedings.html](http://iafor.org/acp_proceedings.html)



- Family Therapeutic Alliance and the Prevention of Relapse in Collectivist Malay Community in Malaysia*  
Zall M.R  
Mahmood N.M pp. 1-11
- Cognitive-Behavioral Therapy of Bipolar Depressive Disorder (Manic-depressive): A Case Study*  
Mohammad Khodayarifard pp. 12-22
- Measuring Trust in China: Resolving Eastern and Western Differences in Concepts of Trust*  
Robert J. Taormina pp. 23-34
- Personal Communicative Activity in a Cultural Adaptation Process*  
Tatiana Pilishvili pp. 35-44
- Overview of conflict occurring in Youth-Headed Households (YHHs) of siblings in Rwanda*  
Immaculée Mukashema pp. 45-56
- Risk Management for the Future: Age, Risk, and Choice Architecture*  
Orly Lobel  
On Amir pp. 57-79
- Meta-analysis of Intelligence Scores of 'Street Children' in Developing Countries*  
Graham Pluck  
Daniel Banda-Cruz pp. 80-91
- Multiple Creativities: A Task to Set up a New Model to Creative Thinking*  
Hossam-Eddin AbulHassan Hassan pp. 92-100
- Taiwanese Parents' Reactions to the Achievement of their Children: Vertical Distinctiveness Versus Horizontal Distinctiveness*  
Kuei-Hsiang Han pp. 101-115
- How to Predict Professional Success in Music and Beyond? Constructing Universal Talent's Structure for the Best Vocational Choices*  
Dina Kirnarskaya pp. 116-125
- Holistic Theory of Behaviour*  
Surendra Nath Dubey pp. 126-147
- Consumer Market for Functional Foods in Thailand*  
Phanchita Methakornkulnan  
Ying-Jiun Hsieh  
Lan-Ying Huang pp. 148-158
- Can Personality Type be Predicted by Social Media Network Structures?*  
Matthew Escobido  
Gillian Stevens pp. 159-173



*The Level of Social Bond among Indonesian Higher-Education Students Who Access Facebook*

Azalia Primadita Muchransyah

Tri Iswardani A

pp. 174-185

*The Role of Empathy in Experiencing of Loneliness of Others and Existential-Behavioral Training in the Empathy Development.*

Emma Meshcheryakova

Elena Litke

pp. 186-192

*Seniors Use of Medical Electric Scooters with the Intention Satisfaction Study in Taiwan*

Win-Chin Lee

Cheng-Hung Huang

Chih-Fu Wu

Yi-Jung Lee

pp. 193-204

*Examining Critical Success Factors for Medical Device Industry in Taiwan*

Ying-Jiun Hsieh

Hui-Ting Lin

pp. 205-220

*Creating an Audio-Tactile Braille Storybook for Visually Impaired Children: The Role of Audio Feedback in Inducing Pleasure*

Sara Partow

pp. 221-235

*Risk Assessment Tool for Adverse Outcomes of Occupational Stress: Development and Investigation of its Psychometric Properties*

Nataša Sedlar

Tatjana Novak

Lilijana Šprah

Gregor Sočan

pp. 236-248

*The Moderating Effect of Work Motivation and Coping Strategies on Job Satisfaction and Psychological Well Being among Fire Fighters*

Mohd. Dahlan Hj. A. Malek

Ida Shafinaz Mohd. Kamil

pp. 249-262

*An Exploratory Study of Core Competencies in Psychological Assessment —A Taiwan Perspective*

Yu-Ling Lan

Yuhsuan Chang

pp. 263-268

*Tragedy Aesthetics of Ki-duk Kim film*

Yu Di Huang

Chien-Chih Lin

Li-Chieh Chen

Mei-Chu Cheng

M-H. Mia Chen

pp. 269-279



- Stress Resistance, Adaptability, and Emotional Stability of Medical Students Obtaining Categories 4 and 5 on the Psychometric Test and Related Factors*  
Sri Linuwih Menaldi  
Adhityawarman Menaldi  
Iwan Dwiprahasto  
Aria Kekalih  
Ova Emilia  
Yayi Suryo Prabandari pp. 280-291
- Emotion Regulation: A Critical Review of Cross-cultural Validity of Emotion Suppression*  
Kullaya Pisitsungkagarn  
Phongmanus Busayaprateep pp. 292-301
- Altruism among Teacher*  
Reza Olitalia  
Erik Wijaya  
Khadijah Almakiyah  
Laksmiari Saraswati pp. 302-311
- Dealing with Emotional Crisis: A Phenomenological Exploration of Thai Helpers' Perception and Experiences*  
Nattasuda Taephant  
Arunya Tuicomepee  
Supapan Kotrajaras pp. 312-318
- Children's Understanding of First- and Second-Order False Beliefs in One Narrative*  
Kumiko Matsumoto pp. 319-329
- Living Arrangements and Adjustment of Elderly Persons*  
Nisha Dilip Mundada  
Revati Hatkanagalekar pp. 330-345
- The Relationships of Trust in Supervisor, On-the-Job Embeddedness, and Intentions to Leave: Testing the Mediating Effect of On-the-Job Embeddedness*  
Debora Purba  
Janneke Oostrom  
Marise Born  
Henk van der Molen pp. 346-348
- Self-Acceptance of Sexual Orientation in Gay Men: A Consensual Qualitative Research*  
Phakphoom Decha-ananwong  
Arunya Tuicomepee  
Supapan Kotrajaras pp. 349-365
- Relations between Intention to Self-change and Cognitions of benefit and Cost to Self-change in University Students*  
Yuta Chishima pp. 366-373

- Consideration of Cross-cultural Issues in Relation to Somatization*  
Ming Meng  
Yue Ling Jin pp. 374-382
- Factoring in the Correct Answers Ratio in a Psycho-Educational Program*  
Yukako Nakane  
Ayako Ito pp. 383-393
- Validation of Psychological Capital Questionnaire in Thai Employees*  
Siriporn Sapyaprapa  
Arunya Tuicomepee  
Rewadee Watakakosol pp. 394-399
- Negligence in a Modern Families Lives*  
Roswiyani Roswiyani pp. 400-405
- Explaining Context Effects through the Perspective of Preference Uncertainty*  
Jih-Jeng Huang pp. 406-418
- Social Policy and Female-Headed Household in the Post Revolutionary Iran*  
Shokouh Dibaji Forooshani pp. 419-427
- Preliminary Study of 3D Base Navigation Websites Development - Use 3D Virtual Temple Navigate Websites for Example*  
Hsuan-Jan Kao  
Li-Chieh Chen pp. 428-449
- The Indonesian Moslem Marital Quality Scale: Development, Validation, and Reliability*  
Hepi Wahyuningsih  
Sartini Nuryoto  
Tina Afiatin  
Avin Helmi pp. 450-462
- Learn to Cope with Hypoglycemia in Patients with Diabetes*  
Fei Ling Wu pp. 463-476
- Competition Anxiety in Egyptians Children Sportsmen*  
Amr Hassan  
Ahmed Ali pp. 477-484
- The Diagnostic Technique of Activity, Action and Deed Reflection*  
Maria Kuznetsova pp. 485-500
- Connectedness between Individul, Community and Environmental Factors in the Process of Recovery People Affected Merapi Eruption in 2010*  
Mellia Christia  
Arnfinn Helleve pp. 501-507



- Modeling Choice Behavior of Delivery Provider of Online Auctioneer*  
 Yi-Wen Kuo  
 Yu-Kai Huang pp. 508-517
- Applying Technology-Mediation to Assist Junior College Students to Learn Japanese as 2<sup>nd</sup> Language and Improve the Efficiency*  
 Shih Hsiu-Ching pp. 518-528
- The Relationship between Analytic and Holistic Styles of Thinking and Forgiveness*  
 Loan Bui  
 Sharon Flicker pp. 529-542
- Development of Resilience Quotient (RQ) Support Activities Set for Disabled Students*  
 Ammaret Netasit pp. 543-553
- Effect of Transpersonal Psychotherapy in Reducing Symptom of Craving and the Level Dependency in People with Substance Use Disorder*  
 Diah Fridari  
 Indra Surya  
 Eko Budi  
 Aninditha Veera  
 Karina Putri  
 Puspasari Dewi  
 Ayana Wiria pp. 554-561
- A Developing Second-order Measurement Model of Thai Adolescent's Desirable Characteristics*  
 Panidaporn Jongrache  
 Puntip Sirivunnabood  
 Penpilai Rithakananone pp. 562-570
- An Analysis of Film Voice-Over and Sound Interpretation Techniques from a Cross-Cultural Perspective*  
 Chun-Wen Fang  
 Li-Chieh Chen  
 Chin Shin Chen pp. 571-577
- Medical Morality in Islamic Civilization*  
 Gholamreza Montazeri pp. 578-582
- Bilingualism Helps Asian Families Flourish*  
 Gina Ko pp. 583-596

*Family Therapeutic Alliance and the Prevention of Relapse in  
Collectivist Malay Community in Malaysia*

Zall, M.R\*<sup>1</sup>, Mahmood N.M\*<sup>2</sup>

\*<sup>1</sup>University Malaysia Sabah (UMS), Malaysia, \*<sup>2</sup>Cyberjaya University College of  
Medical Sciences (CUCMS), Malaysia

0009

The Asian Conference on Psychology & the Behavioral Sciences 2013

Official Conference Proceedings 2013

Abstract

Being a drug addict makes one's alienation possible, even if one belongs to a strong interdependent familial relationship community. Culturally it is simply that he has deviated from his family piously held values and norms. By capitalizing on the idea of therapeutic alliance (Rogers, 1957), researcher managed to identify yet another stronger but slightly different form of therapeutic alliance which is a core value flourishes naturally in the Malay collectivist culture. Working on this collectivist family therapeutic alliance has enhanced effective communication and cooperation among the recovering addict (RA) and their family members which resulted in RA capability to stay drug-free. In this study, four RAs and thirty two of their family members were drawn together to form four research groups. Open-orientation group is adopted to suit the unpredictable group member's attendance during the four-month period of treatment. For the purpose of data collecting, researcher used 3 sets of inventory called Establishing and Maintaining Therapeutic Alliance Inventory or IKMP.1, IKMP.2 and IKMP.3, partly based on modified version of Working Alliance Inventory (WAI: Tracy & Kokotovic version, 1989) format. The results from pre and post-test have shown that there is strong readiness among the subjects to establish and to maintain therapeutic alliance. The follow up test, conducted 2 years after the last research group received treatment, showed that three out of four RAs successfully 'kick the habit' and are living drug free lives.

*Keywords: collectivist family therapeutic alliance, relapse prevention*

iafor

The International Academic Forum

[www.iafor.org](http://www.iafor.org)



## Introduction

In traditional Malay collectivist community he or she who addicted to drug is labeled as deviating against his or her family's values and norms. And to get back into the family circle, one has to go through a long way to prove to the family that he has repented and really committed to a new drug-free life. This is largely due to traditional role as the guardian of the culture/religion played by their parents and families apart from self-guilt experienced by the addict himself. For the family, giving in to a member of the family who is apparently against the family values may be seen as encouraging the addict to continuously using and repeating other unbecoming drug-related behaviors of which also punishable sins from their religious perspective. On the other hand, for the addict to walk straight back into the circle of his family-of-origin, after the 'shameful' and heart breaking experiences inflicted upon his or her family, is a another challenge to the family reunion. In such a situation, action shouldbe taken to help dissolve alienation of recovering drug addict (RA) within his own family and community

There are many Malay old sayings such as, "*Sebusuk-busuk daging, dibasuh, dimakan juga*" and "*Setinggi-tinggi terbang bangau, akhirnya hingga di belakang kerbau,*" (Malay idioms /perumpamaan) which reflect two important values of unconditional positive regard and homecoming. The first saying means no matter how bad a blood brother or a sister is, should he or she repent, he or she should be accepted back into the family. The latter means no matter how far, how long or on what reasons one leaves his family, he will come home eventually. Combining both sayings witness a situation where members of the conflicting parties are showing strong inclination to get together and to revive their familial relationship or "*silaturahmi*" but hindered by various undefined cultural values. Exploring these values may help researcher to get closer to the heart of the problem faced by RA and his family members in Malays collectivist culture.

Respecting the tense relationship amongthe RA and his family members in this research, an acid test is applied to investigate whether the underlying values which determines the nature of therapeutic relationship among collectivist community is strong enough to sweep aside existing conflicts and to establish alliance between them. Inevitably, one of the most challenging tasks of this project is to convince both parties to get together in a group, putting their conflicts aside and work together to achieve the set goal of helping the RA preventing relapse.

### Therapeutic Alliance vs. Collectivist Family Therapeutic Alliance

Rogers (1957) defined therapeutic alliance as, ". . . *the degree to which the client and therapist care about one another and agree on the goals and tasks of therapy.*"The kind of caring is preferable at a high level and strong enough to put aside individual self-interest in helping one another toward achieving the counseling goals. Strupp (1992) put up a stronger definition of therapeutic alliance. He said that the degree of relationship that qualifies for the therapeutic alliance is when individuals are able to

*“communicate commitment, caring, interest, respect, and human concern for the patient.”*

In the Malaysian Malay community, probably as most races of the East collectivist society, a slightly different form of therapeutic alliance or family therapeutic alliance has always been a foundation of family unity. Recognizable associated collectivist values such as faithfulness, family identity and cooperation which related to the concept familial-self (Sinha & Sinha, 1997; Masaka, 2003; Sue & Sue, 2008; Corey, 2008), are functioning similarly to qualities underlying therapeutic alliance mentioned by both Rogers (1957) and Strupp (1992). But as the degree of relationship in the family therapeutic alliance occurs at family level, it is assumed that the alliance created is much stronger than the former alliance. Both Malays cultural and their religious beliefs are part of the enforcing or binding elements to their family alliance. For example, among the traditional collectivist Malays, the belief is that, it is individual's as well as family's responsibilities to uphold the religious value of “*silaturahmi*” or familial relationship and failing to do so, is punishable from their religious perspective. So, in order to uphold this deep rooted value and religious teaching of “*silaturahmi*”, one is ever willing to do as much as he can, even to the extent of “*bergadai bergolok*” (Malay proverb) or giving out to the last-penny.

Considering this cultural and religious value of the Malays, collectivist family therapeutic alliance or simply family therapeutic alliance is defined as “*A nature of relationship that tangled by love and concern for blood brothers/sisters and also by responsibility to balance family homeostasis.*” It differs from the therapeutic alliance (Rogers, 1957) mainly in term of its membership, values and the nature of the relationship it forms.

### Research Background

In 1984, a research found that prisoners charged under Malaysian Dangerous Drug Act (1952, amended 1980) confessed that the issue closest to their heart and found most disturbing about being released (from prisons) was whether or not they would be accepted by their family (Zall, 1984). Again after 20 years, in 2004, the same question was asked to the prisoners from two prisons and one rehabilitation centre (a Therapeutic Community), the answers were the same (Zall, 2004). Another research finding showed that 94.5% residents of a Malaysian Anti-Drug Agency Rehabilitation Center in Sabah chose to go home to their family once they completed their program (Zall, Amran & Ismail, 2007).

### Literature Review

Therapeutic alliance has been widely recognized as basic to therapeutic relation (Corey, 2008). For more than thirty years ago researches showed that quality therapeutic alliance “*is a modest yet robust predictor of treatment outcome in individual psychotherapy with adults*” (Horvath, 1994, 2000; Horvath & Lubrosky, 1993; Horvath & Symonds, 1991; Martin, Farske, & Davis, 2000). For older client, therapeutic alliance measured at the early treatment stage showed a better indicator than the result measured at middle stage (Hovath, 1994, 2001; Hovath & Symonds, 1991). Researchers also found that the alliance between therapists and their clients, and therapists with clients families showing encouraging results (Horvath, 1994a; Perkinson, 2002; Shirk & Karver, 2003; Corey, 2008; Gladding, 2009). In drug addiction treatment, family involvement forms a vital part in counseling (Hook, 2008;



Capuzi & Sauffer, 2008). Family members have the influence in motivating drug addicts to stop taking drug or prevent them from getting involved in dangerous activities (Steinberg, Epstein, McCrady, & Hirsch, 1977). This has been a strong indication that where family forms a significant entity as in the collectivist society, alliance between family members is a potential element to be used in psychotherapy.

### Research Questions /Objective

The main objectives of this study are destined to answer research questions as; i) Whether or not the Malays collectivist RAs and their family members, are willing to go through a therapeutic alliance based group treatment together, in spite of their continuous strenuous relationship? ii) As the treatment meant to empower the family, does the family therapeutic alliance last through a critical period of two years? iii) Does the therapeutic alliance-based empowered family capable of helping the RA prevent relapse? iv) How feasible is a cultural/religious friendly therapeutic alliance based approach used in this study to the clients of Malays collectivist subjects?

### Theoretical Framework

Figure 1 shows the pathway commonly travelled by the Malays drug addicts who walk out on his family's main cultures to embrace or get acculturated into contesting addict sub-culture. When he gains sobriety after doing his time in prison or compulsory drug rehabilitation center, he eventually race home hoping to find shelter under the care of his family. Though most of the time this 'stay in' with the family occur just for a while, before he decide to get back to the old trail to addiction, but this is the point where his motivation to cooperate with the family to prevent relapse is high. Empowered and skilled family members would have the opportunity to take the advantage of this short stay of RA at their family home to form family therapeutic alliance and foster changes in him.

**FIGURE 1  
 MALAY RECOVERING ADDICT HOMECOMING CIRCLE**

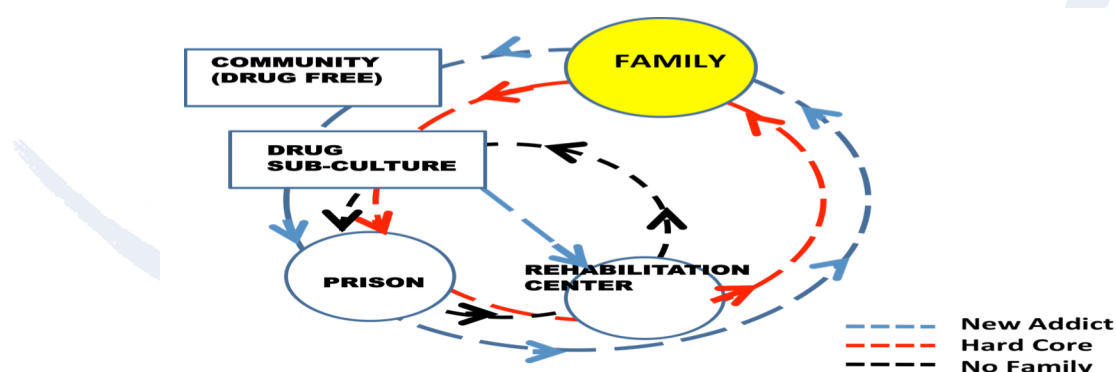

Theories such as system, collectivism, multicultural and social learning theory are used in explaining the research theoretical framework. From social learning theory, the research believes that drug addiction is a socially learned behavior and certainly it can be unlearned. Family approach with multicultural perspective is adopted to enable the family see things from RA's perspective in order to have a deeper understanding of the issues surrounding their RA. The concept of familial-self is strongly supported

by the Malay culture and religious teaching, in which priority is given to family over individual needs. This in turn helps to increase the bargaining power for a therapist to encourage re-establishment of family therapeutic alliance for both RA and his family. Once the subjects enter the alliance, the values of faithfulness, family identity and “*silaturrahim*” are put to their best effect to create feeling of closeness, wanted and love which makes kicking the habit of going back to drug is worthwhile for the RA. This also brings satisfaction to family members as union means to be able to adhere to the religious teaching of “*silaturrahim*” and a chance to balance family homeostasis. The RA would also culturally free himself from the sin of being “*durhaka*” or infidel towards his family especially his parents. In Malay collectivist community, a drug free life is a life that is free from cultural and religious sanctions.

### Methodology

This research uses is a mix-method with field experiment longitudinal design. A purposive-snowball sampling was conducted to select samples for the research. A briefing on the research project was given to a group of 37 final phase residents of one of the Malaysian Government drug rehabilitation program in Kuala Lumpur, Malaysia. Four residents out 7 residents who volunteered to participate and managed to get their families involvement, and selected for this research project.

**Table 1.1: Research Groups**

<b>Families' Labels</b>	<b>Age</b>	<b>Male</b>	<b>Female</b>	<b>Total</b>
Small Family	21 –50 years	2	3	5
Large Family	12– 48 years	4	6	10
Remarried Family	30– 53 years	5	2	7
Extended Family	27– 61 years	8	5	13
		19	16	35

Table 1.1 shows number of groups / families and total members of each individual group i.e. range from 5 to 13 members. Three of the groups are nuclear families while the fourth is extended which shows the participation of an uncle, cousins and brothers /sisters in laws.

A pre and post-test were conducted using a set of questionnaire (IKMP.1, IKMP.2 and IKMP.3) before and after the groups went through 8 sessions of a specially created Collective Family Group Therapy (CFGT). The follow up test was conducted 2 years after all groups completed their treatment sessions.



## **Research Instruments**

Instrument used in this research is called the Readiness to Establish Therapeutic Alliance or IKMP were constructed partly based on modified version of Working Alliance Inventory (WAI: Tracy & Kokotovic, 1989) format. However, IKMP differs from the modified version of WAI (Tracy & Kokotovic, (1989) in many ways i.e. number in inventory sections, its sub-scales used and of course the items. There are only two sections in IKMP (Client Section and Family Section) whereas WAI consists of 3 sections. As IKMP focuses on collectivist clients, it uses 'faithfulness', 'family identity' and 'perception of the treatment approach or family alliance' as its sub-scales. Faithfulness and family identity domains are widely used to measure collectivist trait of interdependent and familial-self (Triandis, Chan, et al. 1995; Masaki Yuki, 2003; Heine, Lehman, Markus, & Kitayama, 1999, Sinha & Sinha, 1997; Kim, 1997). While perception toward treatment and therapist approach is an important indicator for measuring individual's tendency to get professional help (Cusack, Deane, Wilson, & Ciarrochi, 2004).

The first 12 items of the two sections IKMP.1 and IKMP.2 namely the Family Section and the Client Section levels of reliability are 0.76 and 0.95; 0.88 and 0.98 respectively, whereas the follow up IKMP.3 level of reliability is 0.89 (Family Section) and 0.9 (Client Section) as on the Alfa Cronbach.

## **The Treatment Module (Collective Group Family Therapy)**

Based on working experience with Malay clients in Malaysian Prisons more than 30 years, researcher introduced an integrated multicultural family therapeutic alliance based Collective Family Therapy for the treatment of the subjects. Theoretically CFT is an integration of the Structure, Social Constructionism, Adlerian and multicultural theories with underlying Malay collectivist cultural and religious values. The main aim of CFT is to help RAs and family members (co-dependents) to empower their family. Steps are taken to initially redefine certain traditional Malay values that form stumbling block to effective communication, and also by collaborating with values that are commonly embedded in psychotherapy and counselling such as levelling, openness, feedback and confrontation. The long term snowball effect of the therapy is observed in term of family capability to maintain the alliance through the two years critical period and its effect on the group ultimate goal of helping their RAs to prevent relapse.

## **Data Analysis**

For the quantitative data, descriptive analysis is used particularly using percentage, table and also charts to explain data collected during the pre, post and follow up test. This is due to the small sample of research subjects and open group orientation that allows family members attending the treatment sessions based on their free times. On the other hand, qualitative data analysis is used to analysis the data collected through various activities such as observation of the therapy process, structured and unstructured interviews, telephone conversations and short messaging system (SMS). The accessibility of data from numerous resources also enables the researcher to use triangulation method to explain the research conclusion.

## Result

Table: 1.0 shows both qualitative and quantitative evident used to reach at the conclusions. IKMP.1, IKMP.2 and IKMP.3 used at pre, post and follow up test show 100% positive scores. Family identity gets the highest scores of 66.11% and 75.6% respectively. These indicate that family identity is the predictor for readiness to establish and to continue the family therapeutic alliance (after RA completed residential drug program). On the other hand, to be able to really stick to the alliance for a long time, a stronger value of faithfulness toward one's family is essential. Follow-up test shows that faithfulness scores 91.8% and is the indicator for maintaining family therapeutic alliance over a long period or in the case of this study is an interval of 2 years.

Data collected from various resources are used to construct a triangulation, as demonstrates in Table 1.1 below, to explain the research conclusion.

**Table: 1.1**  
**Triangulation Evident**

Evident	Conclusions
1. Subjects successfully forming and maintaining their therapeutic alliance through treatment and interval period of two years.	
2. Data established in form of Metric Resources and Data Extract (Fairclough, 1995) show changes in various aspects of relationship.	1. The subjects were 100% ready to establish and to maintain family therapeutic alliance.
3. All IKMP.1 items scores showed 100% support to establish therapeutic alliance	2. The therapeutic alliance empowered family has a 75% chance to survive through the 2 years critical period.
4. All IKMP.2 items scores showed 100% support to continue therapeutic alliance	3. Family therapeutic alliance capable of helping RAs to stay drug free.
5. All IKMP.3 items scores show 100% support to maintain therapeutic alliance	4. The intervention approach used in this study is feasible in treating collectivist Malays family subjects.
6. Three out of four groups/families (subjects) managed to maintain therapeutic alliance throughout the 2 years critical period	
7. Three out of four RAs managed to stay drug free lives during and after the two years critical period.	

Two critical findings collected from the follow-up test are i) three out of four families managed to maintain therapeutic alliance over the two years of research interval period, and ii) all three RAs from the survived empowered families saw their RAs are able to stay drug free. The family that failed to maintain the therapeutic alliance

among its family members, due to the unsettled broken-home related issues, saw their RA going back to using drug.

As for CFT, the above results are supportive of its feasibility as a treatment approach for research subjects (collectivist Malay families and their RAs). Item number 14 of the IKMP.2, conducted during post-test, “*I agree to recommend for more residents and their families to be treated with this approach (CFT),*” showed a 100% positive response (Agree, 20%; Very Much Agree, 80%)

## Discussion

Homecoming is a common phenomenon among the Malays as well many other Eastern collectivist communities. This phenomenon, as shown in the theoretical framework of this research, is also common among the addicts who had served time in prisons or compulsory rehabilitation center is high despite of their worry of not being accepted by their family (Zall, 1984, 2004; Zall, Amran & Ismail, 2007). Generally they recognize that family is a very significant entity. For an addict, going home also means “...*balik ke pangkal jalan*” (Malay idiom) or go back to where you started (as a non-addict) when you are lost at the end of the road. This old saying has been considered as an advice or a call from the family to its member to stop being unruly.

A related research conducted among addict’s family members and friends show that there is a significant social support for the RAs to start a drug free life (Zall, Balan & Joki, 2009). Since this support is not explicitly echoed to the addicts by the family members due to lack of open-communication between them and also for the fear that they would be taken for granted, alienation among the addict is prevalent. The family seems not trying hard enough to help its member to free themselves from drug addiction.

On the other hand, self-guilt and the uncertainty of the chance to be accepted by their family, due to their past experience of rejection, tend to pull the addict back into the same old track leading them to their addict peers. As it is, both parties seem to have reasons of their own to not start the effective communication ball rolling.

As there are positive inclinations for both parties to re-establish relationship between them, steps to initially educate the family members, helping them to understand the need to get to the bottom of their issues and to revive their hope for a balance family homeostasis, as shown by the research finding, is high. At this point they need a good persuasion or reasons for doing it or even a common goal. The next thing is an appropriate strategy to address the issues around the RA and his family. Consideration should also be given to the cultural values and religious belief of the family. This is where cultural/religious-friendly family therapeutic alliance based therapy (CFT) is crucial, mainly to encourage a full acceptance of the treatment strategy and to effectively mend the rift of communication between the both parties

The Malays cultural/religious teaching demand respect of individual member for the elders, especially one’s parents. This in turn, helpsto ease the elderly members or one’s parents’ role as leaders in his family when the power is made available and strongly supported by the cultural and religious teaching. For example, as



“*silaturahim*” is in their blood and their mind, establishing a proposed family therapeutic alliance to this family is just like helping them to get together again as they used to be but with a new and better perspective of living together. This is a gateway to overcome various issues among the family members, which is most welcomed as in the case of this study.

The cultural and religious demand also reflected during the running of 8 sessions of Collective Family Group Therapy (CFT). Begin with the 100% response to the call for establishing, completing the entire treatment, continuously adapting to the norms and values practiced in the group, and maintaining the alliance throughout the interval of 2 years period. Although family decision sometimes is not truly a collective decision, rather it may be the father’s or parents’ decision, but the inclination to abide to this decision is genuinely resulted out of faithfulness, family identity and “*silaturrahim*”. The fact that a hundred percent readiness to establish, to continue and to maintain therapeutic alliance showed by the subjects in this research demonstrates the support given to the concept of familial-self. It is an imperative act in a collectivist Malay community as it stresses on individuals compliance to give priority to their family over their own individual interests. For example, in this research, to be able to participate in the 8 sessions of all members’ family-of-origin of therapy group, a member is required to leave their own immediate family on weekends for a period of three to four months, abandon other social obligations, and travel over hundreds of kilometers. In a situation like this, one may not hesitate to appreciate the kind of love the members have towards their family which includes the problematic ones.

Therapeutic alliance (Rogers, 1957) in form of family therapeutic alliance is much relevant to the Malays interdependent way of life as it is culturally and religiously supported concept. By integrating certain theories and strategies commonly found in the western originated counseling and psychotherapy with these critical aspects of the Malay community, it has resulted in a friendlier CFT.

### Research Limitation

Obviously one major setback of this study is its small sample. This has greatly affected the data analysis for it minimizes researcher’s option to descriptive and qualitative analysis only. As the treatment approach is combining both RAs and their family in a same group, many potential subjects seem reluctant to come out and to join the research project. Several factors contributed to this refusal such as low confidence in getting familial participation and support, not all RAs, particularly the older ones who still have their family-of-origin around or at least still communicating with them. Most importantly, the researcher is in no position to guarantee positive outcome for those who participated in the research treatment.

Being hardcore and had been in and out of drug programs several times, the RAs are very much exposed to various approaches of counseling and therapies or other modalities but without success. Their perception of an unknown therapy like the one proposed in this study might be just ‘another therapy’. As one of the subjects (RA) commented, when he was first asked for the reason of joining the research project, “I don’t think I can change or get cured, but I would like to give a try especially with my family around”. But the risk he took paid off and now he is living a drug-free life.

## Suggestion

As limitation of this research is small sample, more researches with bigger sample is required in order to get a more satisfactory and consistent results. Even though this research is focusing on Malay subjects, therapeutic alliance or family therapeutic alliance is an approach to bring the traditional values which much relevant in this modern-day Eastern collectivist community. Many aspects both culturally and religiously/spiritually, may be different from one community to another, but values such as living interdependently, faithfulness, family identity and cooperation, which is the core aspects of a strong family therapeutic alliance, are common. Researchers from different ethnic groups seem capable of studying their own family therapeutic alliance and its potential to resolve multiple issues between family members.

## Conclusion

Alienation from one's family-of-origin or the other way round can occur even in a close knitted family such as the collectivist Malay family. This can be caused by the lack of effective communication which is hindered by conflicting values such as the tendency to uphold the '*silaturrahim*' but refusing to have anything to do with a 'sinful person'. Therapeutic alliance in forming a family therapeutic alliance is a convincing way to reunite the family, enhance communication by redefining the conflicting values as well as injecting values common to the psychotherapy or family counseling. The multicultural approach for special group of people such as the Malays of Malaysia (CFGT) would be best if some considerations are given based on various aspects of cultural/ spiritual or religious beliefs of the community.

## References:

- Alexander, J.F., Holtzworth-Munroe, A. & Jameson, P.B. (1994). The process and outcome of marital and family therapy; Research review and evaluation. In A.E. Bergin, and S.L. Garfield (Eds), *Handbooks of Psychotherapy and Behavior Change*. New York: John Wiley and Sons, pp. 595-630.
- Bordin, E. S. (1979). The generalizability of the psychoanalytic of the psychoanalytic concept of the working alliance. *Psychotherapy*, 16, 252-260.
- Corey, G. (2005b). *Theory and practice of group counseling and psychotherapy (7<sup>th</sup> ed.) and Manual*. Belmont, CA: Thomson Brollks /Cole.
- Horvath, A.G., & Greenberg, I.S. (1994). *The working alliance: Theory, research, and practice*. New York: Wiley.
- Horvath, A.O. (1994a). Research on the alliance. In A.O. Horvath & L.S. Greenberg (Eds.) *The working alliance: Theory, research, and practice* (pp. 259-286). New York: Wiley.
- Horvath, A.O., & Greenberg, L.S. (1989). *The working alliance: Theory, research, and practice*. New York; Wiley.
- Horvath, A.G., & Seymond, D.B. (1991). Relationship between working alliance and outcome in psychotherapy: A meta-analysis. *Journal of Counseling Psychology*, 38, 139-149.

- Horvath A. O., & Luborsky, L. (1993). The role of the therapeutic alliance in psychotherapy. *Journal of Consultant and Clinical Psychology*, 61, 561-573.
- House, J. S. (1981). *Work stress and social support*. Reading, M.A: Addison-Wesley.
- Horvath A. O., & Luborsky, L. (1993). The role of the therapeutic alliance in psychotherapy. *Journal of Consultant and Clinical Psychology*, 61, 561-573.
- Horvath, A. O. (1994). Research on the alliance. In A.O. Horvath & L.S. Greenberg (Eds.) *The working alliance: Theory, research, and practice* (pp. 259-286). New York: Wiley.
- Kim, U. (1997). Asian collectivism: An indigenous perspective. In H.R.S., Koa and D. Sinha (Eds) *Asian Perspective on Psychology*. New Delhi: Sage, 147-163.
- Liddle, H. A. (2002) *Multidimensional family therapy treatment (MDFT) for adolescent cannabis users*. Rockvile, MD: Substance Abuse and Mental Health Services Administration..
- Liddle H. A., & Dakof, G.A. (1995) Efficacy of family therapy for drug abuse: Promising but not definitive. *Journal of Marital and Family Therapy*, 21, 511-543.
- Martin, D. J., Garske, J.P. & Davis, M.K. (2000) Relation of the therapeutic alliance with outcome and other variables: A meta-analytic review. *Journal of Consulting and Clinical Psychology*, 68, 438-450.
- Sinha, D., & Sinha, M. (1997). Orientations to psychology: Asian and Western. In S.R. Kao and Sinha (Eds) *Asian Perspectives on Psychology*. Princeton University Press.
- Rogers, C. R. (1957). The necessary and sufficient conditions of therapeutic personality change. *Journal of Consulting Psychology*, 21, 95-103.
- Shirk, S. R. & Karver, M. (2003) Prediction of treatment outcome from relationship variables in child and adolescent therapy. A meta-analytic review. *Journal of Consulting and Clinical Psychology*, 71, 452-464.
- Shweder, R. (1991). *Thinking Through Cultures*. Harvard University Press.
- Stanton, M. D., & Shadish, W. R. (1997) .Outcome, attrition, and family-couple treatment for drug abuse. A meta-analysis and review of the controlled comparative studies. *Psychological Bulletin*, 122, 170-19.
- Triandis, H. C. (1995). *Individualism and Collectivism*. Boulder, Colorado: Westview Press.
- Yalom, I. D. (1985). *Theory and Practice of group psychotherapy* (3<sup>rd</sup>). New York Basic Books.
- Zall, M. R. (1984). *Kaunseling Kelompok; Perbandingan Di antara Pendekatan Terarah Dengan Tanpa Arah. Satu Kajian Kes di Penjara Kajang*, dalam Daftar Bidang Masalah Kepulihan (DBMK): Penilaian Program Pemulihan Dadah Dari Perpektif Penagih Separa-pulih, *Prosiding Persidangan Dadah Kebangsaan I, 2007*, Universiti Malaysia, Sabah.
- Zall, M. R. (2004). *Kaunseling Pra-Kepulihan, Laporan Ilmiah Program Sarjana Kaunseling (Psikologi)*, Universiti Kebangsaan Malaysia, dalam Daftar Bidang Masalah Kepulihan (DBMK): Penilaian Program Pemulihan Dadah Dari Perpektif Penagih Separa-pulih, *Prosiding Persidangan Dadah Kebangsaan I, 2007* Universiti Malaysia, Sabah.
- Zall, M. R. Shuaib, C.D., R. Balan & Joki P.S. (2007). *Hubungan Sokongan Sosial Dengan Kadar Relaps: Satu Kajian Multibudaya Di Sabah, Prosiding Seminar Psikologi SEAP, UMS, 2009*.

*Cognitive-Behavioral Therapy of Bipolar Depressive Disorder (Manic-depressive): A Case Study*

Mohammad Khodayarifard

University of Tehran, Iran

0012

The Asian Conference on Psychology & the Behavioral Sciences 2013

Official Conference Proceedings 2013

Abstract

**Introduction:** The usual treatments of the bipolar depressive disorder, such as medication and electroconvulsive therapy (ECT) have negative side effects on memory and cognition and the likelihood of recurrence. Researchers and clinical experts have been trying to design alternative psychotherapeutic methods for treating this disorder. For example, cognitive behavior therapy (CBT) has been shown to be an efficient treatment.. **Objective:** the purpose of the present case study is to examine the efficiency of CBT combined with medication in the treatment of bipolar depression. **Method:** Two participants with bipolar disorder were treated using CBT and medication. In this method, techniques such as self-monitoring, positivism, relaxation, cognitive re-construction, training problem solving and social skills were applied. **Result:** The results showed that the combination of CBT and medication can be effective in treating bipolar depression. **Conclusion:** The findings, which are congruent with those of previous investigations, indicating that unhealthy beliefs, attitudes and cognitive constructs may play an important role in the formation and continuation of this disorder, and therefore a proper way of treating it would be to work with those unhealthy cognitive constructs.

**Key words:** Mood disorders, bipolar disorder, manic depression, cognitive behavior therapy



## Introduction

Bipolar disorders include type I bipolar disorders, type II bipolar disorder, cyclothymia and the bipolar disorders which have not been specified in other ways. In type I bipolar disorder, the patients have completely manic syndrome or mixed episodes while, in type II bipolar disorder, in contrast to the patients with type I bipolar disorder, they have only mild mania episodes Hypomania cycles and experience one major depression episode (Barlow, 2001). Type II bipolar disorder or recurrent major depressive episodes with hypomania episodes with the prevalence rate of 0.5% in society is one of the most prevalent psychiatric disorders. The important specifications of bipolar depression disorder include severe emotional irregularities and mood fluctuations ranging from major depression to severe mania. This disorder is usually accompanied by committing suicide and results in escape from school, educational dropout, occupational failure and divorce in the patients. Goodwin and Jamison, 1990; quoted from Zaretsky, Segal and Gemar, 1999).

Although recognition and knowledge about depressive-maniac disorder are growing, there are limited studies on bipolar depression therapy. In addition, although medication are common therapies for this disorder, almost all medication have some limitations. For instance, it has been observed that therapy with lithium reduces risk of suicide in the patients with bipolar disorder to 1.6 (Tondol, Jamison and Baldessarini); however, in a long run, lithium protects only 1.2 of the patients with bipolar disorder from the risk of remission. Even in optimal conditions, syndromes of the disorder recur after 2 years (Goldberg, Harrow and Grossman, 1995). Many patients suffering from bipolar depression disorder are resistant to lithium and other medication (Calabrese and Post, 1999; quoted from Williams, 2001) and some cannot tolerate their side effects (Ketler and Post, 1994, quoted from Joffe, 2002). It has been also observed that therapy with lithium leads to more reduction of mania in the patients than reduction of their depression. On the other hand, use of the antidepressants leads to mood instability in the patients suffering from bipolar disorder (Bowden et al., 1994). Although electroshock therapy is effective for the treatment of most major and resistant depressions, it has adverse and undesirable effects on memory and cognition (Hollon, Thase and Markowitz, 2002). For this reason, clinical specialists and researchers have been interested in different psychotherapeutic approaches for treating bipolar disorder which include dynamic psychotherapy, interpersonal psychotherapy and cognitive-behavioral therapy. Moreover, research results have shown that cognitive-behavioral therapy by itself or combined with medication is a more efficient treatment than medication alone, which may not only reduce acute disorders but also prevent from remission of the disorder symptoms and recurrence of the disease in a long run and after stopping medication (Carolyn, 2002, Hollon, Thase and Markowitz, 2002). Most studies which have been conducted so far in this field have concentrated on studying the efficiency of cognitive-behavioral techniques for the treatment of unipolar depression and a limited number of the

studies have evaluated usefulness and effectiveness of cognitive-behavioral therapy in the treatment of bipolar depression. Considering what was said before, the main goal of the present research was to report two successful cases of treating bipolar depression disorder using the cognitive-behavioral therapy techniques combined with psychotherapy.

### **Review of the Literature**

The results of some studies have demonstrated that the cognitive-behavioral therapy approach not only is an efficient therapy for mood disorders but also leads to the creation of some stable skills in the participants, which reduces the possibility of the diseases remission after the therapy (Hollon and Thase, 1983). Some results of these studies are referred to in the rest of this research.

Williams (2001) presented a cognitive-behavioral model for the evaluation and treatment of bipolar disorders and reported a successful therapy case of an adult suffering from bipolar depression disorder using the cognitive-behavioral model. The participant of this research was 43 years old suffering from bipolar disorders who improved within 38 weekly sessions of cognitive-behavioral therapy and had no sign of disorder remission one year after stopping the therapy. This researcher mentioned a five-part evaluation for bipolar disorders in the present cognitive-behavioral approach which included: 1- determining position, conditions, relations and practical problems by the participant, 2- influential thinking, 3- influential feelings, 4- influential physical symptoms and 5- influential behavior.

In the research entitled "treatment and prevention from depression", Hollon, Thase and Markowitz (2002) introduced different efficient therapy methods of depression and bipolar disorders and found that cognitive-behavioral therapy alone or combined with medication was the most efficient therapeutic technique for treating and preventing from the syndrome remission of type I and II bipolar disorder in the patients suffering from these disorders.

### **Research Method**

In this research, two participants (one male and one female) who were suffering from type II bipolar disorders based on the results of clinical interviews, psychiatrist's diagnosis, reference to medical files and diagnostic criteria (DSM-IV-TR) for bipolar disorders were investigated. During the therapy sessions, both participants received therapy using the combined technique of cognitive-behavior therapy and medication. After terminating and stopping therapy sessions, they were followed-up for two years.

The therapy method used in this research was cognitive-behavioral therapy based on the techniques mentioned by Beck (1964). This therapeutic method was first used by Beck (1952) for treating depression. In Beck's cognitive model (1964) on depression, three kinds of cognition were assumed: 1) automatic thoughts, 2) schemas (or influential presuppositions) and 3) cognitive distortions. According to this theory,

influential false beliefs or the schemas which are formed during life of the person result in changes of thoughts, emotions and behavior. Automatic thoughts include the thoughts and imaginations which result from cognitive schemas of people and help in the formation of feelings of uselessness, compunction, incompetence, inadequacy, loneliness and despair in the person. Cognitive distortions also result in negative construction and interpretation of the world, self and ability for effective dealing with future events and adversely affect emotional and behavioral responses of the person. Schemas may remain immobile or stagnant until they are activated by an external event and result in abnormal behaviors and emotional states in people. On this basis, Beck et al. (1979) believed that intervention is an effective strategy at false and useless cognitions level. For this purpose, false beliefs and attitudes of the person should be restructured. Goal of the therapy is to facilitate this change and restructuring which is a kind of participatory empiricism combined with cooperation of the patient and therapist. The patient is conducted toward self-exploration using Socratic Questioning and takes action regarding his/her cognitive restructuring using self-monitoring, positive thinking and problem solving techniques. On the other hand, the results of studies have shown that bipolar depression (BD) disorder is both genetic disposition and results from stresses (Simos, 2001, quoted from Caroline, 2002). In other words, studies have demonstrated that genetic disposition components result in biochemical abnormalities which endanger the patients for showing complete disorder states but genetic problems and factors cannot cause of bipolar disorder by themselves because environmental factors such as stressful ones play an important role in affliction with this disorder. On this basis, clinical specialists and authorities of mental health centers seek to design and develop psychological therapies with the main purpose of reducing stress levels in the people with bipolar depression disorder (Newman et al., 2001). As was mentioned above, cognitive-behavioral therapy of emotional disorders believes that those people who have systematic and regular biases in their thinking processes are at the risk of emergence and intensification of negative and extreme emotions such as anxiety, anger and irritation. This in turn increases their risk of experiencing clinical depression and continuation of these states over time makes the person's attitude negative toward him/herself, others and the world (cognitive triangle of Beck et al., 1979) which exactly indicates depression episode in bipolar depression disorder. On the other hand, extreme negative thoughts become problematic as they are seen in the people with mania. Such thoughts can cause people to do uncontrolled activities such as extravagance, incorrect and unwise sexual behaviors and impulsive decision-making which are problematic. These problematic activities have negative and accumulative consequences which require advanced problem solving and high abilities to cope with the problems, which in turn results in major depression episodes in the people with bipolar depression disorder. Therefore, one of the important goals of cognitive therapy is to reduce psychological stress level in people with this disorder and, as a result, to decrease the probability of experiencing uncontrolled emotional cycles via instructing some skills such as problem solving, positive thinking, self-monitoring and stress relieving. On this basis,

Newman (1999, quoted from Caroline, 2002) mentioned goals and stages of cognitive therapy for bipolar depression disorder as follows:

- 1- Instructing the patients in order to help them understand stylistics, causes, stages of disorder and its therapy methods.
- 2- Identifying and testing thoughts of patients and showing them how to monitor their thoughts and convert their illogical thinking patterns to logical ones.
- 3- Instructing the patients to learn problem-solving principles and methods and to efficiently and effectively solve the problems which they may face.
- 4- Controlling the tendency of patients to be impulsive at the time of manic episodes.
- 5- Adjusting emotional states of patients by pattern forming, role-playing, stress relieving and other skills such as mental training.
- 6- Emphasizing the mutual effect of distraction and disorganization of patients using strategies which maximize planning, focus and repetition.

**Specifications of the first participant:** Mr. M. Sh., 50 years old, holding a Ph.D. degree, university professor, married and having three children: a 25 year old son holding Bachelor's degree and two daughters of 20 years old and student and 17 years old and high school student.

**Therapy period:** 72 sessions, once per week

The participant declared in the first session, "It is 20 years that I am suffering from bipolar depression and experiencing depressive-maniac episodes. I have referred to psychiatrists several times, all of whom agreed on the depression–mania diagnosis and I have always taken their prescribed medicines regularly. But, unfortunately, my depressive–maniac episodes recur after stopping medication which is what bothers me. Now, I am manic for 3 months and I commit activities which I really do not know if they are normal or no. Before this time, I was severely depressed. I feel absurdity, uselessness and hopelessness, my activity level is reduced and I get angry and irritable and I sleep most of the time of the day so that I even have meals in my bed. My father also suffers from this disorder and always experiences depressive-maniac episodes. However, when I am depressed, he is in the manic state and vice versa. I take the medicine prescribed by the physician."

**Therapeutic Measures:** During the first therapeutic session, first, type of disorder, its causes and therapeutic methods were elaborated on for the patient. Then, the therapist asked the participant to specify his work and practical problems, relations, conditions and situations and describe his daily important emotional events during the therapeutic sessions. The participant declared: "my father's behaviors and beliefs have considerable negative effects on me and intensify my mania. My farther does not accept anyone and is very hard-working; he expects me to only deal with my



occupational position, like him, and believes that I am henpecked. He sometimes admires me and sometimes reproaches me severely. His thoughts and actions make me extremely anxious, angry and hopeless." On this basis, the therapist spoke about illogical and false thoughts and imaginations and effect of these false thoughts and beliefs on emotional behavior and states while making an emphasis on the regular consumption of medication prescribed by the psychiatrist and asked the participant to revise his thoughts, attitudes and beliefs, specify negative and illogical thoughts and try to replace them with logical and correct ones (recognizing negative and illogical thoughts). In the following sessions, the participant stated that he was severely affected by his father's hard working and this has led to his extreme activities and that he still has maniac states. In this stage, the therapist instructed the participant to solve problems and asked him to utilize this method while coping with daily problems and consider positive and negative aspects and possible solutions before making a decision and taking any action and then to select the best possible solution. In the next sessions, the participant declared that he was out of the manic state and was severely depressed, bored and isolated so that he did not like to answer his mobile phone and turned it off. He was asleep most of the time and felt hopeless and helpless. In this stage, the therapist took action regarding the use of personal and family positive thinking for the patient and asked him to think about his strengths and fill out the Positive Points Form on a weekly basis. Also, he was asked to have sport activities such as swimming and walking in his routine plans. After several positive thinking sessions, he declared that he was getting better and did not feel distressed; he was doing his routine activities and his isolation and sleepiness were reduced. In this session, the therapist emphasized the role of automatic thoughts and imaginations and asked him to monitor his illogical and false thoughts and to take action regarding the preparation of illogical thoughts chart (self-monitoring) on a weekly basis. In the next sessions, the participant declared: "although my depression has reduced considerably and the psychiatrist has reduced my medicines by half, I still think that the only cause of my depression is my relationship with my father and occupational partnership with him. My father cannot tolerate any independent success of me and tries to make me dependent on him. This issue makes me severely anxious because I am a religious person and believe that my religious duty is to obey my father and fulfill his requirements and, if not, I will feel anxious and guilty and I will feel that I have not performed my religious duties." In this session, the therapist instructed the participant how to relieve stress and asked him to practice stress relieving for 30 min on a daily basis while filling out the Positive Points Form and self-monitoring chart every week. He was also asked to attempt to use problem solving method in coping with his problems and select the best solution for the problem and cope with the problem because problem solving logically reduces negative and distressing emotions such as compunction and anxiety (in this stage, the therapist instructed him to solve problems by pattern forming). In the final sessions, the participant said that his dependence on his father has been reduced and he is less affected by his illogical thoughts; as a result, he feels hopeless, valueless and guilty to a less extent. He was improved completely and performed his routine activities normally, he did not feel hopeless and normally

slept so that the psychiatrist completely stopped his medicines. Although he was not taking any medication, his work and routine activities were satisfactory and successful and he could make decisions and take actions independently and without reliance on his father.

**Specifications of the second participant:** Ms. N. Sh., 25 years old, holding high school diploma, housewife, married and having one 4 year old son

**Therapy period:** 35 sessions with the reference of once a week

The participant said in the first session: "I have got married for 6 years and my major problem is myself; that I am very pessimistic and quarrelsome. I have decided to get a divorce from my husband. My husband did not hold a wedding party due to financial problems; but, he purchased a house for his mother immediately after our marriage. Now, he fulfills all my needs but I am irritated by his relationship with his family. My husband says that he cannot tolerate my pessimism. I am severely depressed and referred to the psychiatrist many times; they diagnosed my bipolar depression and prescribed medication. I regularly take my medication but I never get better. I have quarrelsome state; I am anxious and act aggressively toward others. Even I cannot have a good relationship with my son (crying). Recently, there was a struggle between my mother and husband which aggravated the situation. Before marriage, I was very happy. I was a student of chemistry but I stopped my study after 2 years. Another issue which bothers me a lot is my overweight. After marriage, I gained 35 kilogram and now I am 105 kilogram. My husband only asks me not to cry out and not to curse him and our son but I cannot be like that, especially in the manic state; I hit my husband and I always insult his family. I am always thinking about suicide and once I committed suicide by taking many tablets (sobbing). I have intensive and strange hostility toward my husband's family because I blame them for the death of my child last year. I have come at my husband with a knife in the manic state several times and once I threw a vase on his head when we fought together. But he only curled up in a corner and did not show any reactions. His inattention and indifference drive me crazy. Now, I am experiencing depression episode. I do abnormal things in the manic state and strongly bother my husband."

**Therapeutic methods and measures:** in the primary sessions, the therapist elaborated on the type of disorder and its therapeutic ways and, considering her major depression, the therapist specified illogical and false beliefs, attitudes and thoughts of the participant and asked her to monitor her illogical thoughts and beliefs while making an emphasis on the role of negative thoughts in the expression of false behaviors and trying to replace them with logical and correct thoughts (recognizing negative and illogical beliefs and thoughts ). The participant was also asked to complete her illogical thought self-reporting chart on a weekly basis (self monitoring). In the following sessions, the participant stated: "my excessive pessimism toward my husband's family is the origin of all of my distresses. My pessimism has family origins. My mother is severely pessimistic which aggravates my pessimism. My sister

and brother are also affected by my mother's pessimistic thoughts, like me, and they are also pessimistic. They also have an excessive and illogical dependence on my mother, just like me. On the other hand, I consult with my mother in all of my affairs due to my excessive dependence on her; however, both my husband and I are annoyed with this work. My husband has false and negative thoughts about my mother and this bothers me. He believes that there is matriarchy in our family. On the one hand, I am interested in and dependent on my mother and, on the other, I am bothered by her improper effects on me and my married life. This makes me angry and generates compunction in me." In this stage, the therapist instructed problem-solving method and asked the participant to consider all the possible solutions and hypotheses and select the best solution and apply this method for all social and family problems. In this session, the therapist perceived that she should reduce her illogical and excessive dependence on her mother. The participant was asked to do exercises such as walking and swimming on a daily basis. Moreover, during separate sessions, her mother was treated. In the next sessions, the participant declared that she got better using the methods mentioned in the previous sessions and had better relations with her husband. But, she was feeling useless and hopeless and was desperate. In this stage, the therapist took action regarding personal and family positive thinking and asked the participant to complete the Positive Points Form every week. In the next session, she declared that she was getting better so that her medicine dose was reduced by the psychologist and the medication were reduced almost by half. She was trying to contact her mother only once a week and not to be affected by her pessimism and illogical thoughts. Nevertheless, she got angry and cried. In fact, when her demands were not fulfilled, she suffered from anxiety, worries and could not control her anger. In this session, the therapist asked the participant to exercise stress relieving for 20 to 30 min after instructing how to relieve stress. In the individual and separate sessions, her husband was interviewed and asked not to intensify excessive dependence of his wife on her mother and facilitate her treatment. In a common session, the couple was instructed to solve problems through pattern forming in order to use this method at the time of marital disputes. Also, false and illogical attitudes toward each other were corrected and adjusted using cognitive restructuring technique. After several sessions, the participant declared that she did not feel useless and hopeless, her pessimistic thoughts were reduced and her relations with her husband and his family were very good and satisfactory. The only concern was his overweight which would be controlled by physical exercises, walking and going on a diet. The participant also stated that: "my mother ruled over our family all the time and I also liked to be like her because I was dependent on her. Although I love her, my excessive dependence on my mother bothers me which causes conflict and compunction in me. My mother has committed suicide in my presence several times. She is always depressed and I think that I am affected by her false and illogical behaviors and thoughts and these false thoughts cause pessimism, hate and false behaviors." In this stage, the therapist spoke about negative and illogical thoughts and their effect on behaviors and emotional states and asked the participant to replace negative and illogical thoughts with the positive ones. For this purpose, she was asked to prepare a thought self-

monitoring chart every day and continue stress relieving exercises. In a common session, the couple was recommended to have positive thinking and they were asked to fill out the Positive Points Form about each other and their families in the following weeks. In the next sessions, the participant declared that she was well and had no problem and was satisfied with her life and the psychiatrist completely stopped her medication. It is necessary to note that none of the participants of the present research showed sign of disorder recurrence and no depressive-manic episodes started after the treatment in the one-year follow-up stage.

### **Discussion and Conclusion:**

Findings of the present research showed that CBT combined with medication is an effective therapy for the people suffering from bipolar depressive disorder. As mentioned before, both participants of the present research received long-term medical treatment before participation in the psychotherapy sessions, but once their medication stopped, their symptoms recurred and they were in manic-depressive states again. However, when they participated in the weekly psychotherapy sessions based on cognitive-behavioral techniques combined with medication, they not only improved, but also did not show any symptoms in a one-year follow-up, even though their medication had been stopped for one year. This indicates high efficacy of CBT in the treatment of people suffering from bipolar disorders. Moreover, the findings of the present research were in line with those of Beck's cognitive model (1964) and demonstrated that irrational and non-realistic beliefs, attitudes and thoughts play an important role in the formation and continuation of the syndrome of this disorder. As was evident in the comments of the first participant, an important and critical illogical belief of this participant was related to her dependence on the father and responsibility toward his demands and even his illogical demands. This false belief that he was religiously bound to act according to his father's illogical words and demands led to the formation of negative emotions and behaviors in him. Concurrent with the participant's insight in this regard that this belief was a negative and illogical one and after replacing illogical and negative beliefs, his treatment trend was accelerated and facilitated. In the second participant, mutual dependence of her and her mother on each other and her conflict in this regard, i.e. her interest in her mother, very supportive role of the mother and the mother's interferences, illogical thoughts and beliefs, affected the participant and resulted in her pessimism, which had a very important role in the formation and continuation of the disorder syndrome. After specifying and solving this conflicting and illogical belief, the participant rapidly recovered. It is necessary to note that the reason for longer trend of treatment in the first participant was his long record of affliction with this disease. As mentioned above, the first participant was suffering from this disorder for 20 years while the second one suffered from the disorder for 6 years, which resulted in more complexity of the disorder and length of treatment in the first case.



It is necessary to note that one of the reasons which facilitated the treatment of participants in this study was active and useful cooperation of their families in the therapy process.

Results of this research were congruent with results of Hollon and Tesson (1983), Hollon, Thase and Markowitz (2002) and Williams (2001).

The results of the research by Hollon and Tesson (1983) showed that cognitive-behavioral therapy techniques resulted in the generation of stability skills in the patients which prevented from the remission of the disease. On the other hand, Hollon, Thase and Markowitz (2002) demonstrated that cognitive-behavioral therapy techniques alone or along with medication therapy were more efficient in the treatment of bipolar disorders. Findings of the research conducted by Williams (2001) and Zaretsky, Segal and Gemar (1999) indicated high efficiency of cognitive-behavioral therapy techniques in the treatment of bipolar disorders.

One of the limitations of this research was using a limited number of participants (two participants) and absence of a control group. It is recommended for future studies to compare cognitive-behavioral therapy techniques alone, or cognitive-behavioral therapy techniques along with medication therapy and medication alone with each other with the cooperation of more participants in order to obtain more accurate and reliable results.

#### References:

- American Psychiatric Association(2000 ).(*Diagnostic and statistical manual of mental Disorders Fourth Edition Text Revision* ,Washington, DC: American Psychiatric Association.
- Barlow, D.H.(2001). *Clinical Handbook of Psychological disorders (Third editoion)*. NewYork, London: The Guilford Press.
- Beck, A.T.(1952). Successful outpatient psychotherapy of a chronic schizophrenic with a delusion based on borrow guilt. *Psychiatry*, 15, 305-312.
- Beck, A.T.(1964). *Thinking and depression: II.Theory and Therapy*. Archives of General Psychiatry, 10, 561-571.
- Beck, A.T., Rush, A.J., Shaw, B.F., & Emery, G.(1979). *Cognitive therapy of Depression*. New York: Guilford Press.
- Bowden, CL., Brugget, AM., Swarm, AC., Calabrese, JR., Janicak, PG., Petty, F., & others.(1994). Efficacy of divalproex vs. Lithium and placebo, *Jama*, 271, 918-924.
- Carolyn,J.(2002). Cognitive therapy for Bipolar Disorder: A therapist's Guide to concepts, Methods and practice. *Behavior Research and Therapy*, 4.(3), 343-344.

- Goldberg, J.F.; Harrow, M.; & Grossman, L.S.(1995). Course and outcome in bipolar affective disorder a longitudinal follow-up study. *American Journal of Psychiatry*, 152, 379-384.
- Hollon, S.D., Thase, M.E., & Markowitz, J.C.(2002). treatment and prevention of depression. *Psychological Science*, 3(2), 39-40.
- Hollon, S.D., & Tauson, W.B.(1983). *the cognitive pharmacotherapy project: study design, outcome, and clinical follow-up*. Paper present at the world congress of behaviour therapy. Washington, D.C.
- Joffe, R.T.(2002). Psychotherapeutic approaches to bipolar depression. *Clinical Neuroscience Research*, 2(3,4), 252-256.
- Williams, CH.(2001). A response to a case of lacanian psychosis: a cognitive behaviour therapy perspective. *European Journal of Psychotherapy, Counselling and Health*, 4(2), 215-224.
- Tondol, L; Jamison, KR; & Baldessarini, R.J.(1997). Antisuicide effects of Lithium. *Ann N Y Acad Sci*, 36, 339-351.
- Zaretsky, A.E.; Segal, Z.V.; & Gemar, M.(1999). Cognitive therapy for bipolar depression: A pilot study. *Canadian Journal of Psychiatry*, 44(5), 491-494.

*Measuring Trust in China: Resolving Eastern and Western Differences in Concepts of Trust*

Robert J. Taormina

University of Macau, Macao

0035

The Asian Conference on Psychology & the Behavioral Sciences 2013

Official Conference Proceedings 2013

Abstract

Trust has implicit meaning for every person and has different meanings in different cultures, making it difficult to measure across cultures. From an International Psychology perspective, contrary to those who suggest creating “different psychologies” for different nations, this paper builds on scientific knowledge by using tested principles and instruments and applying them with contextual sensitivity to other cultures. After examining the concept of trust in the literature, an operational definition of trust is offered. Then, cultural differences, such as individualism and collectivism, are discussed in relation to the way trust is perceived in China and the West. Results are presented of some early attempts to assess trust in China using a western instrument, which revealed certain research anomalies, particularly low reliabilities for the measure. When relevant cultural differences were taken into consideration, and minor adjustments were made in the approach to measuring trust, primarily in the instructions for the respondents to complete the questionnaire, the results showed a marked increase in the reliability values of the trust measure. Also, examples of the successful use of this approach are shown in research results with regressions that used the trust measure. It is concluded that western measures based on sound scientific research can be used successfully in China with relatively minor adjustments if researchers carefully consider the cultural context, supporting the idea that, instead of creating “different psychologies,” International Psychology can be developed as a coherent branch of psychology by basing international research on existing scientific principles.

iafor  
The International Academic Forum  
[www.iafor.org](http://www.iafor.org)

## Background of the Problem

In terms of International Psychology, some authors suggest writing “different psychologies” for different cultures; but that approach runs counter to scientific progress, which carefully identifies “universal” principles and builds on them. To develop International Psychology requires building upon scientific knowledge by using tested principles and instruments and applying them with contextual sensitivity to other cultures. This paper describes how this can be achieved when measuring trust in China.

Measuring “Trust” has never been easy, and measuring it in China requires some additional considerations that must be addressed in order to obtain accurate and reliable assessments of the psychological construct of trust. Researchers often use existing measures that have been developed in western countries, especially the USA, and many such measures can work in eastern cultures when careful procedures are utilized to provide translations with equivalent meanings. Some variables, however, do not provide acceptable reliability values, which make them difficult to use in the Asian context. Trust is one such variable that has been difficult to measure in China. This may be due to several reasons, and this paper investigates some reasons related to cultural differences in how trust is conceived and how trust is measured.

## Defining Trust

The scientific study of any concept requires that it must first be clearly defined, which validates the concept and allows it to be better understood and more reliably measured. In reviewing definitions of trust, one aspect is striking, namely, that the definitions often center on the negative aspect of trust, i.e., researchers and theorists have stressed that the “risk” of other people taking advantage of you is essential to the definition of trust (MacCrimmon and Wehrung, 1986) and that the person must be willing to be “vulnerable” to that possibility. For example, Rousseau, Sitkin, Burt, and Camerer (1998) defined trust as “*the intention to accept vulnerability based on positive expectations of the intentions or behavior of another*” (p. 395).

Another weakness of existing definitions is that they use positive or negative consequences of the other person’s behavior on the person viewing that behavior as a part of the definition. This is a weakness because it adds conditions (or contingencies) as if they were part of the definition even though those conditions are not inherent in the concept itself. For example, Robinson (1996) defined trust as “*expectations, assumptions, or beliefs about the likelihood that another’s future actions will be beneficial, favorable, or at least not detrimental to one’s interests*” (p. 567). This definition cannot be used as it imposes conditions of self-interest.

As the previous definitions are unscientific since they impose negative concepts (e.g., risk or self-interest) that are not *essential* to trust, a more positive view is taken here by defining trust as “*a conviction that another person will perform certain actions, or behave as promised.*” Since this is a more scientific definition that focuses on the central concept (without imposing any conditions), it should be universal, i.e., it should apply to any culture. This definition also reflects a social psychological approach, i.e., that trust is important to one’s interpersonal interactions. Thus, a discussion of cross-cultural differences in the concept can now be made.

## Cultural Differences in the Concepts of Trust

Culture is defined as the attitudes, values, beliefs, and behaviors shared by a group of



people (Triandis, 1996), and groups can be of any size and as large as whole societies. There appear to be east-west cultural differences in all the aspects of culture (e.g., values) regarding trust. Fukuyama (1995) argued that Chinese society can be characterized as being low on trust because they only trust members of their own in-group, while distrusting anyone else since all people who are not in one's family are members of the out-group. Based on the World Value Survey (Inglehart, Basanez, and Moreno, 1998), people in eastern countries have less trust than people in western countries, with the Chinese showing less trust than Americans. The Japanese, likewise, have a lower level of trust than do Americans (Yamagishi, 2011).

**Collectivism versus Individualism.** Reasons for the low trust may be based in the strong collectivism of Chinese culture (Hofstede, 1980), in which people have a strong attachment to in-group members, a long-term orientation, and a desire for social harmony. For the Chinese, the family is the core in-group. As Yang (1995) explained, Chinese people have unconditional trust in their own family, but view everyone else with great distrust. In western culture, which is characterized by a strong individualism (Hofstede, 1980), every individual is thought to have a different level of trustworthiness, such that everyone has a different degree of trust of other people. This is the tenet upon which measures of trust have been based, i.e., they assess responses to statements about the trustworthiness of other people, *in general*, by asking the individual how much he or she agrees or disagrees with those statements; and such measures are assumed to reflect the extent to which that individual trusts other people.

Given these strong cultural differences, the contrast between cultures comes into play when measuring trust. That is, the curve for measures of trust among Americans, who are from an individualistic western culture, is expected to have levels that follow a "normal curve" as regards views about the trustworthiness of others; whereas Chinese people, from a collectivist culture, vary only on a pure duality, i.e., in-group members are trusted while all out-group members are not trusted. This may be depicted in the following figure (Figure 1):

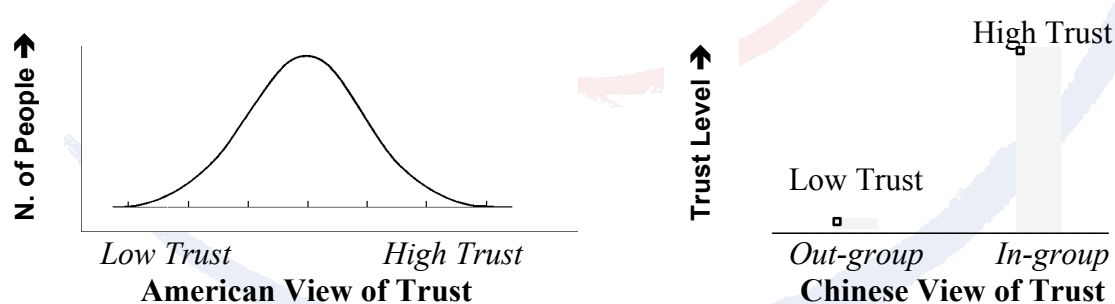

**Eastern Internal and Western External Views of Trust.** For the Chinese and their in-group collectivism, the family is the core group of society, with all family members deemed fully trustworthy. All other people are out-group members who must prove they can be trusted by being consistently honest, reliable, etc., over a long-term time frame. Thus, the Chinese think "trust" must be earned by other people, suggesting it is "external" to them. For Americans, in accord with the individualism value, every person has a different "level" of trustworthiness (including family members, i.e., even they might not be reliable)! From this perspective, since everyone is different, the objective in measuring trust is to assess it internally: How much will a given person

“generally” trust other people? This question derives from the expectation that people have individual differences in attitudes, values, and beliefs, etc., and that their answers provide a projection of their “*internal*” level of trust onto other unknown people.

***Trust and the Time Perspective.*** Contributing to the cultural differences in the concept of trust is the sense of time. American culture uses a short-term time perspective, while Chinese culture uses a long-term perspective. For example, Americans tend to want things to happen quickly such that they enter into enterprises (e.g., making “deals”) with other people using a relatively fast decision-making procedure (e.g., so they can make a “fast buck”), which also requires a fast decision on whether to trust the other person, even though they know some risk might be involved. The Chinese, on the other hand, tend to ***not*** enter into quick deals, and prefer instead to establish a personal relationship first so that the other person’s reliability can be assessed over a longer period of time, which allows the Chinese to minimize the chance of risk and increase their sense of trust in the other person *before* entering into an endeavor.

### **The Trust Measure**

A discussion of problems with measuring trust in China would not be complete without an example of a trust measure and the difficulties associated with using it. A popular measure of trust has been Rotter’s (1967) 25-item Interpersonal Trust Scale (see Robinson, Shaver, and Wrightsman, 1991, for the items) which has been used in the USA for 46 years. Below are 12 of the original items [R = Reverse-worded item]:

1. Hypocrisy is on the increase in society [R]
2. Fear of punishment rather than conscience prevents most people from breaking the law [R]
3. Most salesmen are honest in describing their products
4. Most people would be horrified if they knew how much news is distorted [R]
5. In spite of what people say, most people are only interested in their own welfare [R]
6. Parents usually can be relied on to keep their promises
7. Most experts can be relied upon to tell the truth about the limits of their knowledge
8. Most people can be counted on to do what they say they will do
9. Most people answer public opinion polls honestly
10. Despite reports in the news media, it is hard to get objective accounts of public events [R]
11. These days one has to be alert or someone is likely to take advantage of you [R]
12. Most idealists are sincere and usually practice what they preach

Unfortunately, problems arose when scales composed of these items were used to measure trust in China. (The problems are described in the subsequent section of this paper).

In an attempt to make the items simpler to understand and easier to translate, a shorter 10-item Trust Scale was developed. Four items were selected (with minor edits) from Rotter’s (1967) scale that were relatively easy to understand, while dropping others that seemed unsuited to Chinese culture (e.g., about idealists). One item from Costa and McCrae’s (1992) Trust Scale and five newly created items were added. This gave a set of 10 easy-to-understand items with low ambiguity, which was expected to increase reliability:

# Item	Source
1. Hypocrisy is on the increase among them [R]	Rotter (1967)
2. They are primarily interested in their own welfare [R]	Rotter (1967)
3. I believe they can be trusted.	Newly created
4. I have to be alert or they are likely to take advantage of me [R]	Rotter (1967)
5. Their behavior reveals what they think	Newly created
6. I think they are basically not honest [R]	Rotter (1967)
7. If I ask them to keep a secret, they will do so	Newly created
8. They can be relied upon to tell the truth	Newly created
9. I believe they have very good intentions	Costa and McCrae (1992)
10. Most of them are sincere	Newly created

### Research Anomalies Encountered in Measuring Trust in China

The main problems in measuring trust in China are based in the cultural differences, which, as discussed earlier, relate to how persons in the different cultures view other people in the society, i.e., they (a) have individual differences in trustworthiness, versus (b) are a trustable in-group member or an untrustworthy out-group member. In addition to the difference in cultural perspectives, other problems have arisen that are associated with the *techniques* used to measure Trust. [At this point, it should be noted that there could be a variety of reasons responsible for measurement difficulties, such as problems with translation, but this paper assumes that appropriate methods, e.g., having skilled translators and using back-translation, can be used to assure accuracy in the translations.]

Therefore, this section addresses some problems with measuring trust in China in addition to the cultural issues. In particular, there were statistical problems that needed to be corrected, such as those related to: (a) the reliability of items, (b) results from reverse-worded items, and (c) the use of Likert scales.

**(a) Reliability of the Rotter (1967) Trust Scale.** When the Rotter (1967) scale was used in China, despite the scale's success in the West, the Cronbach alpha reliabilities had been consistently low (even after careful back-translation of each of the items); ranging only from about .49 to .55, which falls considerably short of the .70 value that is usually recommended as a good minimum value for scale reliability (Nunnally, 1978).

To determine the cause of the low reliabilities, in pilot studies, debriefings were conducted with respondents, who said they did not know to whom the questions referred. The Chinese respondents, when asked to give a score on the trust measure, expected the researchers to refer to some specific person. For example, regarding the item that says "*Most people can be counted on to do what they say they will do,*" respondents wanted to know who "*most people*" are. But in the West, the implicit assumption is that the scale will determine how trusting a person is according to their responses to questions about the trustworthiness of other people *in general*. The Chinese take the questions literally, and expect the researcher to identify some specific target person for the respondents to evaluate! This, in the minds of Chinese respondents, creates ambiguity, which may partly explain the low reliabilities.

**(b) Reversed Wording and the use of Factor Analysis.** Psychometric theory recommends including “reversed” (negatively worded) items, in measuring attitudes (to avoid problems of common method bias). But in Asian societies, negative wording creates bad feelings since such statements could lead to disharmony when spoken openly. This is undesirable because “social harmony” has been the principal moral precept for Chinese society since it was endorsed by Confucius 2500 years ago (Hu, 1997), and this dictum remains so important in modern Asian societies, especially in China (Tsai, 2006), that is has even been called the “ultimate good” (Yang, 1995). The Japanese, for example, rarely use the word “no,” and when it is used, it is placed at end of sentence to allow the speaker to assess how the idea is being received by the listener, giving the speaker a chance to avoid using the negative if the listener seems unhappy with what is being said.

The Chinese also avoid using negatives to avoid conflict. To preserve social harmony when they are with people other than family members, the Chinese would rather say nothing than openly say anything contradictory, and therefore avoid negative statements. This means they are often not sure how to answer a negatively worded statement, particularly if a Likert-type response scale is used, which includes agree (positive) and disagree (negative) responses.

This is problematic because a Chinese respondent might want to disagree with a negative statement, which creates the problem of cognitively dealing with a double negative when even a direct negative statement is inconsistent with the Chinese culture. For example, it is easier to disagree with the positive statement “Most people can be trusted” than it is to disagree with the negative statement “Most people can *not* be trusted.” Hence, negative items produce a type of cognitive dissonance for many Chinese, making them unsure of what to do, such that they responded differently to positively worded and negatively worded items.

Factor analysis of positively and negatively worded items reveals how the two types of items are perceived differently. When the items from a single scale create two different mental (cognitive) states, this could result in dissimilar responses, producing a 2-factor solution with a clear split between the items. The positively worded items load heavily on one factor, and the negatively worded items load heavily on a second factor. Interestingly, the negative items *load positively* on a separate factor, rather than negatively on the factor with the positive items. This is depicted in a factor analysis for a trust measure used in China (N=198):

#	Items from the Trust Measure	Factor 1	Factor 2
1	Hypocrisy is on the increase among them [R]	.11	<b>.81</b>
2	They are primarily interested in their own welfare [R]	.03	<b>.83</b>
3	I believe they can be trusted.	<b>.66</b>	.29
4	I have to be alert or they are likely to take advantage of me[R]	.13	<b>.76</b>
5	Their behavior reveals what they think	<b>.51</b>	-.23
6	I think they are basically not honest [R]	.27	<b>.63</b>
7	If I ask them to keep a secret, they will do so	<b>.73</b>	.08
8	They can be relied upon to tell the truth	<b>.67</b>	.19
9	I believe they have very good intentions	<b>.77</b>	.16
10	Most of them are sincere	<b>.72</b>	.29

(c) **The Use of Likert Scales.** Some researchers have had difficulty using Likert scales in China. Rensis Likert (1932) conducted extensive research on the number of response points in his type of scale, ranging from 2-point (disagree or agree) to 22-point scales, and reported that the “most reliable” scale was the 11-point scale. In the last 50 years, however, researchers tended to favor the 7-point scale (as an approximation of the 11-point scale) that often yields acceptable psychometrics. Unfortunately, many researchers only label the anchor points (1=strongly disagree, 7=strongly agree) but do not label the other (2~6) points, assuming the respondent will understand what they mean. In China, however, the respondents often ask the researcher what those scale points mean. Whereas they are unclear about the meaning of those numbers, the responses were inconsistent, which yielded low scale reliabilities.

### **Solutions to the Problems of Measuring Trust in China**

Summarizing the major problems with measuring trust in China, these were: (1) differences in the way trust is envisioned due to differences in eastern and western culture, including social attitudes about in-group and out-group members and the importance of short- vs. long-term time frames in developing trust; (2) the problem of Chinese respondents having difficulty understanding the meaning of some of the points on the Likert scale; and (3) low reliability of the trust scale, including the use of items that are reverse worded (which are scientifically recommended in order to achieve psychometric accuracy when using questionnaires). These problems are addressed individually below.

**Solving the Cultural In-group vs. Out-group and the Time Perspective Problems.** First, there was a need to resolve the East-West cultural differences in social perceptions of trust. As can be seen from Figure 1, the assumptions in measurement of the Trust concept are very different. Therefore, to make the measurement method more usable across cultures, some adjustments needed to be made in the approach. This was centered in the wording of the *question* to better fit the culture, i.e., to revise the instructions for responding to the items.

As may be inferred from this discussion, researchers can solve the problems of both the time perspective and duality in collectivist cultures by asking the Chinese about trust in a culturally appropriate way. Specifically, the question must first ask the Chinese respondent to exclude consideration of family members. Further, to make the question more meaningful, the referents (or target persons) in the question need to refer to more salient persons, i.e., people whom the respondent can readily imagine, such as people with whom the respondent interacts. Consequently, the resultant question, to be more culturally relevant, must refer to salient target-persons, i.e., “*Not including your family members, how much do you agree or disagree that the following statements describe the people with whom you interact?*”

Thus, by specifying that the question asks about the extent of trust *only of out-group members* that the respondent knows, the question becomes less ambiguous, which should produce more precise answers. That is, when considering the strong duality in Chinese culture regarding trusting family members while not trusting other people, the result yields a more accurate assessment of the extent to which there are differences in the level of trust that different Chinese people have of out-group members. (This solution is based on the assumption that everyone has certain inherent



differences regardless of whether one is from an individualistic or a collectivist culture, and that the extent of their trust is also different.) The result will be an assessment of trust that yields a scale with a higher degree of internal reliability.

**Resolving Ambiguity in Using Likert Scales.** One solution to the problem of the Chinese not understanding the meaning of some points on the Likert 7-point response continuum is to shorten it to a 5-point scale (as fewer points reduces ambiguity), and label all the points, thus:

<b>Strongly disagree</b>	<b>Somewhat disagree</b>	<b>Not sure</b>	<b>Somewhat agree</b>	<b>Strongly agree</b>
<b>1</b>	<b>2</b>	<b>3</b>	<b>4</b>	<b>5</b>

**Solution to the Reliability Problem.** Finally, correcting the low reliability of the Trust Scale can be achieved by (a) reducing the ambiguity of the directions, (b) simplifying the wording of the items for easier understanding, and (c) clarifying the points on the Likert scale. All three of these approaches, which have been described above, achieved success. Evidence of higher reliabilities based on the recommended changes can be seen in the Cronbach Alpha values obtained on the Trust measure in China before and after the changes were introduced, as revealed in the following table:

<b>Scale</b>	<b>Year Tested</b>	<b>Reliability</b>	<b>Authors</b>
Rotter (1967)	2003	.49	Taormina (pilot test)
Rotter (1967)	2004	.55	Taormina (pilot test)
Revised	2005	<b>.85</b>	Taormina (pilot test)
Revised	2009	<b>.80</b>	Taormina and Hu
Revised	2010	<b>.84</b>	Taormina and U
Revised	2012	<b>.82</b>	Taormina and Ho (in press)

Clearly, the changes greatly improved reliability of the measure, with the major change being in the instructions, which addressed the cultural difference in how Chinese and Americans view the trustworthiness of other people. Also, the negative wording problem is resolved because, although the positive and negative items still form two factors, the overall reliability of the Trust scale is high.

### **Sample Results of Research Using Trust in China**

Here are some results of research that was conducted by the author and some colleagues that used the revised wording in the instructions, slight edits to the wording of the items, and the shorter (5-point) Likert scale to measure trust in China.

**Antecedents of Interpersonal Trust in China** (Taormina and U, 2010); Trust Alpha = .84. The first example is from a multiple regression analysis of a study that investigated whether interpersonal trust is affected by other variables. The predictor variables tested included some standard demographics, and independent variables such as the satisfaction of one's needs, some (Big-5) personality variables, happiness, self-confidence, and family emotional support.

Criterion/Predictors	Beta	t-value	$\Delta R^2$	$R^2$	$F$	$df$
<b>Interpersonal Trust</b>				.32	26.93****	5, 266
Self-Confidence	-.06	-1.01				
<b>Happiness</b>	.17	2.83 **	.02			
Physiological Needs Satisfied	-.06	-1.09				
<b>Safety Needs Satisfied</b>	.23	4.22 ****	.15			
<b>Belonging Needs Satisfied</b>	.19	3.15 ***	.04			
Esteem Needs Satisfied	.08	1.27				
Self-Actualization Satisfied	.05	0.76				
Conscientiousness	.10	1.94				
Extraversion	.09	1.60				
Neuroticism	-.10	-1.71				
<b>Emotional Intelligence</b>	.15	2.64 **	.07			
Chinese Values	.05	0.10				
Family Emotional Support	.04	0.59				
Gender	-.07	-1.32				
Age	-.01	-0.11				
Marital Status	.08	1.02				
<b>Number of Children</b>	-.25	-4.95 ****	.04			
Education Level	.05	0.89				
Employment Status	-.01	-0.26				
Monthly Income	-.01	-0.27				

\* $p < .05$ ; \*\* $p < .01$ ; \*\*\* $p < .005$ ; \*\*\*\* $p < .001$ . (N=272)

As can be seen from the above table, there was considerable success in the culturally sensitive approach to measuring Trust in China, particularly using instructions that fit the cultural context (i.e., asking only about out-group members); which yielded some revealing results.

The following tables, which also used the new Trust measure and new instructions, show the results of two regressions from a separate study that examined antecedents of trust among the Chinese, and to determine if trust could influence a workplace variable. The significant results suggest considerable success with the new approach to measuring trust in China.

**Antecedents & Outcomes of Trust in China** (Taormina and Sun, 2011). Trust Alpha = .75. This study also examined factors that might influence Trust in China, but used a somewhat different set of independent variables.

Criterion/Predictors	Beta	t-value	$\Delta R^2$	$R^2$	$F$	$df$
<b>Interpersonal Trust</b>				.16	17.89****	3, 274
Family Emotional Support	.06	.90				
Cognitive Flexibility	.07	1.05				
Dependency	-.06	.90				
Self-assurance	-.00	-.06				
Emotional Intelligence	.09	1.56				
<b>Openness</b>	.12	<b>2.04 *</b>	<b>.01</b>			
<b>Agreeableness</b>	.28	<b>4.52 ****</b>	<b>.13</b>			
<b>Neuroticism</b>	-.13	<b>-2.10 *</b>	<b>.02</b>			
Self-esteem	-.10	-1.40				
Gender	.05	.85				
Age	-.08	-1.33				
Marital Status	-.02	-.43				
Number of Children	.01	.18				
Education Level	.09	1.52				
Employment Status	.08	1.38				
Monthly Income	.06	1.04				

\* $p < .05$ ; \*\* $p < .01$ ; \*\*\* $p < .005$ ; \*\*\*\* $p < .001$  (N=301).

*Antecedents & Outcomes of Trust in China* (Taormina and Sun, 2011). Trust Alpha = .75. This is part of that same study, but included an outcome variable, i.e., coworker support, to assess whether the level of Chinese people's interpersonal trust might have an effect on their interactions with coworkers.

Criterion/Predictors	Beta	t-value	$\Delta R^2$	$R^2$	$F$	$df$
<b>Coworker Support</b>				.22	20.30****	4, 267
<b>Interpersonal Trust</b>	.30	<b>5.37 ****</b>	<b>.13</b>			
<b>Family Emotional Support</b>	.12	<b>2.15 *</b>	<b>.01</b>			
Cognitive Flexibility	.09	1.56				
Dependency	.04	.64				
Self-assurance	.17	<b>3.04 ***</b>	<b>.03</b>			
Emotional Intelligence	.02	.27				
Openness	.03	.58				
Agreeableness	.02	.23				
Neuroticism	.08	1.38				
Self-esteem	.08	1.14				
Gender	.07	1.25				
Age	-.06	-1.15				
Marital Status	-.02	-.38				
Number of Children	.02	.28				
Education Level	.00	.04				
Employment Status	.08	1.38				
<b>Monthly Income</b>	.20	<b>3.63 ****</b>	<b>.05</b>			

\* $p < .05$ ; \*\* $p < .01$ ; \*\*\* $p < .005$ ; \*\*\*\* $p < .001$  (N=301).

### Summary and Conclusions

This paper examined problems often encountered in assessing interpersonal trust in China when using a popular western measure. Apart from minor psychometric issues

related to item wording and using a Likert scale, the main concern centered on cultural differences between the ways Chinese and Americans view the trustworthiness of other people. When the cultural differences were addressed by revising the instructions for responding to the questionnaire, the reliability value of the scale increased substantially. It is concluded that western measures that are based on sound scientific research can be used successfully, with relatively minor adjustments, if researchers carefully consider the cultural context. Thus, instead of creating "separate psychologies," International Psychology can be developed as a coherent branch of psychology by basing international research on existing scientific principles.

## References

- Costa, P.T., and McCrae, R.R., 1992. *Revised NEO Personality Inventory (NEO-PI-R) and NEO 5-Factor Inventory professional manual*. Odessa, FL: Psychological Assessment.
- Fukuyama, F., 1995. *Trust: Social virtue and the creation of prosperity*. New York:Free Press.
- Hofstede, G., 1980. *Culture's consequences: International differences in work-related values*. Beverly Hills, CA: Sage.
- Hu, S., 1997. Confucianism and western democracy. *Journal of Contemporary China*, 6(15), pp.347-363.
- Inglehart, R., Basanez, M., and Moreno, A., 1998. *Human cultures and beliefs: A cross-cultural sourcebook: Political, religious, sexual, and economic norms in 43 societies: Findings from 1990-1993 World Values Survey*. Ann Arbor: University of Michigan.
- Likert, R., 1932. A technique for the measurement of attitudes. *Archives of Psychology*, 22(140), pp.44-52.
- MacCrimmon, K.R., and Wehrung, D.A., 1986. *Taking risks: The management of uncertainty*. New York: Free Press.
- Nunnally, J.C., 1978. *Psychometric theory*. 2nd ed. New York: McGraw-Hill.
- Robinson, S.L., 1996. Trust and breach of the psychological contract. *Administrative Science Quarterly*, 41(4), pp.574-599.
- Robinson, J.P., Shaver, P.R., & Wrightsman, L.S. (1991), *Measures of personality and social psychological attitudes*. New York: Academic Press.
- Rotter, J.B., 1967. A new scale for the measurement of interpersonal trust. *Journal of Personality*, 35(4), 651-665.
- Rousseau, D.M., Sitkin, S.B., Burt, R.S., and Camerer, C., 1998. Not so different after all: A cross-discipline view of trust. *Academy of Management Review*, 23(3), pp.393-404.
- Taormina, R.J., and Ho, I., (in press). Intimate relationship quality: Predictors across genders for dating, engaged, and married individuals. *Journal of Relationships Research*.
- Taormina, R.J., and Sun, B., 2011. Antecedents and outcomes of trust in China (unpublished).
- Taormina, R.J., and U, W.S., 2010. Antecedents of interpersonal trust in China (unpublished).
- Triandis, H.C., 1996. The psychological measurement of cultural syndromes. *American Psychologist*, 51(4), pp.407-415.
- Tsai, M.C., 2006. Sociable resources and close relationships: Intimate relatives and friends in Taiwan. *Journal of Social and Personal Relationships*, 23(1),

pp.151-169.

Yamagishi, T., 2011. *Trust: The evolutionary game of mind and society*. New York: Springer.

Yang, K.S., 1995, Chinese social orientation: An integrative analysis. In: T.Y. Lin, W.S. Tseng, and E.K. Yeh, eds. *Chinese societies and mental health*. Hong Kong: Oxford University Press. (pp. 19-39).

The logo for 'iafor' is centered on the page. It consists of the lowercase letters 'iafor' in a light blue, sans-serif font. The text is enclosed within a circular graphic composed of two overlapping, hand-drawn style arcs. The outer arc is a light red color, and the inner arc is a light blue color, matching the text. The arcs are thick and have a slightly irregular, brush-like texture.

iafor



*Personal Communicative Activity in a Cultural Adaptation Process*

Tatiana Pilishvili

People's Friendship University of Russia, Russia

0044

The Asian Conference on Psychology & the Behavioral Sciences 2013

Official Conference Proceedings 2013

Abstract

The personal activity problem is connected with the increasing speed of society life, communication capabilities, which form a special person's relationship with other people and objective reality. On the one hand, it helps to ensure that the person has more resources and ways of self-realization. But at the same time such a high-speed and full of requirements reality became the cause of passivity, infantilism of an individual, who prefers not really to act, but only to serve needs illusory. A genuine dialogue is replaced by surface contacts that not require a deep sense of trust in the communication. The results of activity's study in People's Friendship University of Russia (PFUR, Moscow, Russia) show, that the sense of alienation in the cultural sphere demonstrates the importance of cognitive "us" and "them" categorization for a more successful cultural adaptation. Feeling of homesickness and own uselessness in a new social situation indicate, that the aggregate internal cognitive and emotional causes lead to the dreams returning at home, where people feel their own importance, from the actual situation of failure in a foreign country. Chinese students in Moscow show a great need to communicate with the Russian and experiencing a sense of recovery, when they feel their own importance and the fact that "they've been noticed". This is contrary to the Russian students opinion, that the Chinese are accustomed to only communicate with their countrymen and do not feel the need to communicate with other cultures. Emerging communication barriers needs professional psychological intervention.

**Keywords:** personal activity, structural-content and functional components of activity, adaptive activity, effective coping, cross-cultural communication.

iafor  
The International Academic Forum  
[www.iafor.org](http://www.iafor.org)

## Introduction

The problem of adaptation to another country conditions is high actual today because of the intensive cross-cultural communication among people all over the world. Despite of quantity publications in general, social and ethnic psychology, optimum behavior parameters, that provide concrete person to join another's culture life without serious negative consequences are not found. Comprehensive researches confirm the fact that the cross-cultural adaptation is connected first of all with what kind of internal position and line of conduct was selected by the person. With personal adaptability are connected not only understanding of another's culture features, comprehension of degree of its affinity, but also the relation (more or less tolerant) to it.

T.G. Stefanenko (2000) writes that cross-cultural adaptation is the process of entering a different culture, the gradual development of its rules and traditions. The author identifies the following factors that influence the process of adaptation to the new cultural environment: individual differences (demographic and personal), individual life experience circumstances (pre-exposure experience, arrival motives, language skills). Both can be subjectively or objectively difficult for individual. Cross-cultural adaptation is defined as a phenomenon by individuals who, while moving in an unfamiliar social and cultural environment, strive to establish and maintain relatively stable, reciprocal and functional relationship with a new situation. Adaptation is an activity which describes a compromise vector in the internal cultural structure and external ambient pressure. Personal activity in a cross-cultural communication provides overcoming the difficulties, connected with misunderstanding and sense of alienation.

As T.S. Medvedskaya (2009) shows, there are four functional components in activity structure, which occur in adaptation process: a) substantially-cognitive component; b) operative-motivational component; c) appraisal-behavioral component; d) personal-productive component.

*Substantially-cognitive component* is an assimilation system and perceived knowledge about the activity nature; it's a presentation of anyone as an active subject, who takes responsibility for what is happening with him in his life. This component also provides a categorization of active and passive concepts in the communication process. Some people access events as occurring accidentally, so they think that cross-cultural communication doesn't depend on themselves and proceeds spontaneously. Other people estimate communication as a process which depends on them, and make concrete efforts to improve the understanding and overcoming cultural barriers, showing a much higher degree of activity at this level.

A.V. Libina (2009) understands activity as a process and result of subject development at the time while solving constantly emerging challenges and difficulties. From this point of view a substantially-cognitive activity component is implemented in the locus of control, taking responsibility for what is happening, understanding the required behavior scheme. Cognitive coping includes the processes of logical analysis as well as situation reactions positive reappraisal. It's being expressed, that in

overcoming the consciousness focusing on every aspect of the situation, the extraction and use of information from the relevant past experience are the most important.

*Operative-motivational component* acts as a bridge between the substantially-cognitive component as well as appraisal-behavioral component. It's formed in the process of transition from awareness of own active participation in life through goal-setting and planning of specific activities to certain behavioral strategies. Thanks to this component the learned norms of activity content is implemented in personal behavior. The significance of the operative-motivational component is determined by its relationship with the internal standards and the adoption of the activity established boundaries as a moral principle. Depending on the dominant motive the person would show the different activity in a particular area of life. With this component is given an explanation about the active or passive individual behavior in a concrete situation.

In a cultural adaptation process the operative-motivational activity component is expressed in the desire to overcome any difficulties or avoid them. Motivation to succeed enhances individual social connections. For successful adaptation person receives the necessary social informational, moral and other support. Indeed, one of the most important factors positively affecting the adaptation process is the establishment of friendly relations with the majority group (Russians).

Foreigners who have friends among the local residents have the opportunity to learn unwritten rules of behavior in a new culture; they can get more information about how to behave. Informal interpersonal relations with compatriots may also contribute to the successful adaptation, as friends from the native country perform the function of social support. However, in this case the limited social interaction with the new culture can enhance the sense of alienation. If personal motivation is to avoid the difficulties with new circumstances then a number of his or her social bonds remain low, that doesn't contribute to adaptation, but rather becomes the cause of individual isolation from the new cultural environment. Nostalgia for homeland constantly pulling the person in the past, it's very hard to solve the life problems "here and now".

*Appraisal-behavioral component* is characterized by its expression in relation to others, in achieving goals etc. To understand the way of the development, the person asks him or herself: "What have I done to be like I am now?", so it means, that we ask ourselves about that things, that are connected with the appraisal-behavioral component of activity, whatever sphere of life it may concern. From this point of view the activity is directly related to a person chosen vital strategy. K.A. Abulkhanova-Slavskaya (1991) believes that the strategy of life in the broadest sense of the word (as opposed to the many vital tactics) – is the individual ability to his or her identity connection with the conditions of life, to its reproduction and development. For each person there is own unique way of life, a way of structuring, organization, evaluation, interpretation. That's why there is a need to distinguish between different scientific ways of life activity. In a new cultural situation person needs more complex range of activities in connection with the fundamentally different external conditions and internal experience. At this level to overcome the difficulties is to find new ways by implementing specific actions to deal with the situation and its consequences.

*Personal-productive component* refers to the extent of the activity personal significance, productivity level of ongoing efforts to address the existing situational

conditions. This component indicates how successful / unsuccessful people cope with changing environmental conditions, how efficiently they allows stressful situations, which level of the social and psychological adaptation they have. According to P.K. Anokhin (1998), behavioral act serves as a complex functional system, which consists of a "hub mechanisms," which has a certain effect (outcome). A.V. Libina (2008, p. 174) thinks, that we can study the process of existing conditions proactive overcoming, including not only the concrete result (positive, neutral or negative), but also person's satisfaction with the results and himself. From this point of view, personal-productive activity component is a response, in which behavioral act is implemented as a functional system (more or less productive) in cognitive, motivational, behavioral spheres. With proactive overcoming of serious life difficulties as well as everyday situations people become subjects of activity and continuously transform a special relationship with the environment. The latest leads to the personality development, world view, self-perception, place in life, internal resources and capabilities.

Personal-productive activity component features are associated with the life way, which is the focus of many psychological studies (V. Frankl, 1993; K.A. Abul'hanova-Slavskaja, 1991; S.L. Rubinstein, 2000; A.A. Kronik, 1998; T.I. Kolesnikova, 2003). In this case a concrete life situation and the result of human interaction with it appears, according to A.V. Libina, as a "universal measurement's unit of personal life continuum" (2008, p. 130). Productive situation resolving determines the further individual's activity, in which the subject feels himself able to transform reality and himself. Productive activity in cognitive, emotional and behavioral spheres is a measure of how right a person chooses the resolving the situational constraints process. The concept of productive coping fundamentally changes the relationship to a successful person. They are, from this point of view, is not only winners, but also just common people, openly negotiating with themselves, others and life. Overcoming behavior is understood, according to N.G. Osuhova, as "life situations transformation strategy" (2007, p. 49), for which the goal is clearly characterized as well as conscious rational ways to cope with external challenges and internal feelings.

Productive / unproductive problem solving is associated with many components, in particular with the phenomenon of M. Seligman's term "learned helplessness" (2011), when often repeated failures situations lead to avoidance of obstacles install, and consequently to passive response to what is happen. A.V. Libina (2008) shows, that active coping in cognitive sphere includes preserving adequate perception of the situation, the analysis of the incident, the differentiation of own position and other people opinion, finding control points in the successful resolution of the situation in the past, creating a positive mental outlook. In the emotional sphere are considered active strategies expressing own feelings and providing support search from the people around, the manifestation of empathy to other people as well as self-empathy. In behavioral sphere strategies are productive, when there is collaboration with other people, creating promising relationship, adequate self-regulation and search for new opportunities to concentrate efforts on the most important, flexibility and proactive behavior.

The difficulties experienced in dealing with other people associate with self-doubt and emotional problems when negative emotions and expectations prevail over positive

emotions. As our previous study shows (Medvedskaya, 2010 a), the feeling of alienation in a cultural environment is associated with almost all scales of A.I. Krupnov's "Adaptation" Inventory. It indicates a solid foundation of categorization "us" and "them" for a more or less successful cultural adaptation. Feeling of homesickness and own uselessness in a new social situation are related to each other, indicating that the aggregate internal cognitive and emotional causes leading to the return of their dreams at home, where people feel their own importance, from the situation of failure in a foreign country, where a person sometimes feel discarded, "alien".

In this case constant thoughts and feelings that return in his or her past are associated with lack of success in the present, when a new situation requires the active involvement in the process of communication with new culture. In this case the person turns out to be in a vicious circle where the negative experience in intercultural communication and a denial from it brings to the past. In this case nostalgia and the desire to return to native country contribute to a growing rejection of dialogue with other people, communication doesn't improve, someone feels uncomfortable and experiences frustration in the present.

It's identified significant differences in coping with the process of adaptation, which are on a continuum between active and passive coping. The first is seen in the desire to change the situation and may be similar to a problem-oriented coping adaptation. This type of coping may be relatively productive when the majority society has little interest in meeting the needs of minority or there is negative attitude about it. Passive coping reflects the patience and self-modification, and reminds intercultural strategy of assimilation. This strategy may be successful only when the dominant society has a positive attitude and ready to accept new members of cultural groups. If the relationship between "we" and "they" are hostile, the passive coping strategy is likely to lead to high levels of intergroup discrimination and ethnocentrism. From this point of view integration is positively correlated with goals orientation, separation is positively associated with a focus on the emotional state and its avoidance, assimilation is positively correlated with the orientation of both the task and the emotions.

## **Method**

The present study is part of the Study "Personal activity in modern communication systems: content features or appearance". The work was done on the basis of the agricultural, philological, environmental faculties (Peoples' Friendship University of Russia). To study the personal communicative activity in a cultural adaptation process 60 Chinese students, 19-23 years old were engaged. There were used the following Russian adapted diagnostic techniques: "The Motive-enactment Test" (J. Kuhl), "Cognitive Orientation" (J. Rotter), "Indicator Strategies" (D. Amirkhan), "Motivation to Success" (T. Ehlers), "Motivation to Avoid Failure" (T. Ehlers), "The Coping Strategies Inventory" (R. Lazarus), "Identification of Individual Coping Strategies" (E. Heim), "Picture Frustration Test" (S. Rosenzweig), "Adaptation" Inventory (A.I. Krupnov). For processing the empirical data there were used mathematical-statistical and qualitative analysis ( $X^2$  Pearson, t-t-test, correlation and factor analysis). It was also organized the Multicultural training with 9 Chinese students to study deeper communicative activity in a cultural adaptation process.



## Results

A comparative analysis of the sign distribution at the level of substantially-cognitive activity component shows significant differences in locus of control ( $X^2_{0,010} = 11,67$ ); it's also identified gender differences in the direction of the reaction ( $X^2_{0,002} = 12,18$ ), indicating that Chinese girls more likely than boys to feel responsible for what happens. At the level of the operative-motivational component observed differences in the sample on the scale of the action / state orientation ( $X^2_{0,01} = 11,08$ ). In the study sample, the number of young men with a focus on action is higher than among girls. There are differences in motivation for avoiding failure between boys and girls ( $X^2_{0,026} = 40,41$ ), with higher girls' rates. At the level of an appraisal-behavioral component there are observed gender differences in the action control in failure situation ( $X^2_{0,001} = 36,41$ ), with higher scale results among young men. There are differences in how often students choosing search social support strategies ( $X^2_{0,01} = 41,24$ ), the average on the scale inherent in most young men, and Chinese girls have higher results.

There are significant differences between boys and girls on a the reaction pathway scale in the situation full of obstacles ( $X^2_{0,05} = 5,74$ ). Young men in a stressful situation related to the decision to overcome the difficulties, often react to it, blaming others for what happened. In charge situation are revealed the same differences on the distribution of response types ( $X^2_{0,03} = 6,75$ ) and the direction of the reaction ( $X^2_{0,04} = 6,48$ ) between boys and girls. While young men often exhibit extra punitive behavior, the girls go on to solve the problem with self-incrimination. In the sample there are gender differences on the scale of escape - avoidance ( $X^2_{0,002} = 41,72$ ), with higher values on the scale among girls. In cognitive sphere boys use productively coping offer than girls ( $X^2_{0,035} = 6,69$ ). In emotional sphere boys compared with girls increasingly express confidence in difficult situations ( $X^2_{0,027} = 7,26$ ).

To study the groups oriented on action / state, in terms of the operative-motivational component it was used t-test. It's revealed that at the level of substantially-cognitive activity component observed differences in internal locus of control between the two groups of subjects ( $t = 5,65$ ,  $p \leq 0,001$ ). State focused subjects' external locus value is higher than that of action-oriented students ( $t = 5,77$ ,  $p \leq 0,001$ ). In the group focused on the state subjects, the average value of taking responsibility is higher than that of the action-oriented subjects ( $t = 3,17$ ,  $p \leq 0,002$ ).

At the level of the operative-motivational activity component are revealed differences on the scale of the motivation for avoidance ( $t = 2,25$ ,  $p \leq 0,025$ ). At the level of appraisal-behavioral component action-oriented subjects have a higher score on the scale of solving problem ( $t = 3,01$ ,  $p \leq 0,003$ ), while a state focused participants revealed a higher score to search for social support ( $t = 3,31$ ,  $p \leq 0,001$ ) and avoidance ( $t = 3,44$ ,  $p \leq 0,001$ ). There is a higher average score on the scale of responsibility acceptance ( $t = 3,17$ ,  $p \leq 0,002$ ) and escape - avoidance ( $t = 4,58$ ,  $p \leq 0,001$ ) among state focused subjects. In the based on action sample are found a higher average score on planning solutions ( $t = 3,24$ ,  $p \leq 0,001$ ).

In the statistical analysis with Spearman criteria is revealed that the communicative aspect of Chinese students adaptability in this sample was positively correlated with

the scales of confidence ( $S_{0,01} = 0,616$ ), emotional experience ( $S_{0,01} = 0,639$ ) and alienation ( $S_{0,01} = 0,501$ ). The confidence component is also positively associated with emotional experience ( $S_{0,01} = 0,626$ ), nostalgia ( $S_{0,01} = 0,394$ ) and alienation ( $S_{0,01} = 0,491$ ). The latter correlates with nostalgia ( $S_{0,01} = 0,537$ ), and the scale of adaptability, in turn, is negatively related to the scale of homesickness ( $S_{0,01} = -0,533$ ).

Factor analysis using the principal components method and Varimax rotation allowed overall factorization variable at personal-productive activity component. As shown statistically, the first common factor of productive coping, explaining about 32% of the total variance, consists of searching social support (0,58), confrontation (0,68), distancing (0,68), self-control (0,64), taking responsibility (0,54) and the escape-avoidance (0,74), so this factor is called "efforts to change the situation". The second productive overcoming stressful situations factor, which explains about 17% of the total variance, includes problem solution (0,67), motivation for success (0,64), planning solutions (0,78) and a positive re-evaluation of the situation (0,6) because of this we have identified it as a factor "independent active resolution of the situation". The third factor explaining about 12% of the total variance, consists of internal control locus (0,84), control the operation in case of failure (0,54), as well as the external locus with negative sign (-0,87), so that's why it's interpreted as a factor "self-control of planned and committed activities".

## Discussion

The results indicate that Chinese students sufficiently positive to other ethnic and social groups, however, they face significant challenges in adapting to the new multicultural environment, have some serious communication difficulties and feel confident enough in Russia. Definite fixation on their own ethnicity may reflect the internal setting of Chinese students to the unconscious opposition to the new social and cultural environment in which the transition to the new environment of the study group members felt as a threat to their own ethnic integrity. Subjects of this sample have an overall controversial background, on which the adaptation process to a new cultural environment bases, coupled with a sufficiently high interactivity, as well as conservatism, a desire to control the new environment without regarding students' individual characteristics. The latter, apparently, is connected not only with a negative other groups attitude but also with the ethnic ontogenesis features, when every Chinese is instilled the idea of the society primacy over the individual.

These results appear to be due to the fact that the difficulties faced by Chinese students to communicate with other people associated with self-doubt and emotional problems when negative emotions and expectations prevail over positive emotions. In addition, the sense of alienation in Russia is connected with almost all the test scales adaptability, indicating that the sense of alienation in the cultural sphere demonstrates the importance of cognitive "us" and "them" categorization for a more successful cultural adaptation. Feeling of homesickness and own uselessness in a new social situation are closely related. This apparently means the aggregate internal cognitive and emotional causes leading to the return in their dreams to their homeland, where the subjects feel their own importance, from the situation of failure in a foreign country, where Chinese students often feel thrown "strangers".

In this situation low value of adaptability and simultaneously high nostalgia show that persistent thoughts and feelings that return someone in the past, are associated with lack of success in the present, when a new situation requires more personal involvement in the process of communication with the foreign culture. In this case, the subjects appear as if in a vicious circle where a negative experience in intercultural communication leads to avoidance from it and to past life dreams activation. Nostalgia and the desire to return home contribute to a growing rejection of dialogue with other people, communication doesn't improve, a person feels uncomfortable, and even more are existing the frustration of present situation.

It is interesting that in spite of high behavior flexibility degree the Chinese students are often not able to forgive mistakes, it's difficult for them to endure physical or psychological discomfort. Students of the sample expressed a high degree of readiness for tolerance, first of all, at the social level, but also a feeling of depression associated with negative emotions and alienation.

Thus, the Chinese students, experiencing steady desire to adapt successfully at social and psychological level, feel the nostalgia that often lead to negative emotional states and non-communication with the new environment. The latter leads to an even more isolation, rooted in the past and growth depression. In this case, the ability to hide their own negative feelings is certain obstacle to cross-cultural understanding, as it's often seen around like avoiding interaction with the new environment as unwillingness to cooperate.

In a stressful situation, Chinese students often use a strategy to solve the problem, which may be associated with a desire to act independently, while seeking support from the native environment. Students in this sample perceive the world as a complex, unpredictable, full of incomprehensible meaning and living rather chaotic, but not according to certain laws of justice or logic. A person in this cold, uncontrollable world, has its place, it seems rather successful, must hope on him or herself, has to show high self-control and live in the present, not predicting anything beforehand. This indicates a certain social field-dependence on the environment. Existence in it it's determined by case, so it is unpredictable and unavoidable, that causes more contemplative than the active view of the world. Life goes more in the past and present than in the future, and the satisfaction with the past and present part of life is often low.

Chinese students are capable less accurate than other estimate the state, feelings and desires of people in their non-verbal expressions, facial expressions, postures, gestures, which is probably due to the low level of non-verbal expressivity that is acceptable to the Chinese culture. For students of the study sample is more complex to orient in the verbal context of the situation, to understand clear what people say to each other. Students in this group also often have difficulty in analyzing situations of interpersonal interaction, which could negatively affect the process of communication and adaptation in general.

### **Conclusion and implication**

Summing up, it should be noted that Chinese students, showing a high level of activity during studying process are in some kind of isolation from the big society,

resulting in a predominantly passive-avoidant coping strategies of adaptation. The conducted cross-cultural training has shown, that Chinese students, in particular, noted the complexity of Russian language as avoidable, but the communicational difficulties seemed to them as a more serious obstacle to the understanding of other cultures. In addition it should be noted, that in a multicultural space of Peoples' Friendship University of Russia Chinese students do not feel the understanding from other students for objective reasons related to the low level of knowledge about the culture and its specificity. For example, when in framework of cross-cultural training Chinese student was asked to list the factors that helped and hindered in communication, he repeated several times some of "roots" and their effect on health. However, other presented students perceived this information as wrong because of language mistake and weren't psychologically prepared to its reinterpretation. In fact the Chinese student pointed in this case to assistance of the "here and now" relationships with ancestors, emphasized the importance of family in a difficult situation. So it should be noted the importance of a better understanding of cultures participating in a multicultural communication PFUR space to increase the activity of students in the adaptation process. With creating the conditions for understanding on the substantially-cognitive component's and operative-motivational component's level, it may be expected a more active coping behavior at different stages of acculturation.

The problem of tolerant and simultaneously active behavior in the multicultural world is connected not only with the foreigners relation to other communication participants, but also with "Natives" who indirectly appears connected with the process of cultural shock stages passage and more or less successful adaptation of foreign students in Russia. Therefore is required active participation in acculturation process both foreigners and the Russian students. The latter by the way may solve the internal and interpersonal problems in the course of dialogue with "Others", unlike them people, living on the own laws and traditions.

### **Acknowledgements**

The work is supported by the Russian Humanitarian Scientific Foundation, grant № 12-06-00488a.

### **References**

1. Abul'hanova-Slavskaja, K.A. (1991). *Strategija zhizni*. – M.: Mysl'. – 299 p.
2. Anohin P.K. (1998). *Kibernetika funkcional'nyh sistem*. – M.: Medicina. – 397 s.
3. Bowles T., Fallon B.J. (2003). The Experience of Changing and the Relationship between Changing and Coping: an Adult Perspective // *Australian Journal of Psychology*, Volume 55, № 1, April, p. 43–50.
4. Greenglass, E. (2002). Chapter 3. Proactive coping. In Frydenberg E. (Ed.), *Beyond coping: Meeting goals, vision, and challenges*. London: Oxford University Press, pp. 37-62.
5. Hajkin, V.L. (2000). *Aktivnost' (harakteristiki i razvitie)*. – M.: Moskovskij psihologo-social'nyj institut; Voronezh: Izdatel'stvo NPO «MODJeK». – 448 p.
6. Hersch G.I., Lamport N.K. (2005). Coffey M.S. *Activity analysis: application to occupation*, the USA SLACK Incorporated, 179 p.

7. Ivashchenko, A.V., Karabushchenko, N.B., Pilishvili, T.S., Chkhikvadze, T.V. (2012). Sbornik metodik po izucheniju aktivnosti lichnosti v sovremennyh kommunikacionnyh sistemah [Tekst] : nauchnoe izdanie / A.V. Ivashchenko, N.B. Karabushchenko, T.S. Pilishvili, T.V. Chkhikvadze – M.: RUDN. – 143 p.
8. Johnson Sheri L. (2000). Stress, coping, and depression, L. Erlbaum Associates, 358 p.
9. Karabushchenko, N.B. (2011). Urovni jelitologicheskogo formirovanija lichnosti. Vestnik Rossijskogo universiteta druzhby narodov. Serija: Psihologija i pedagogika, 4, 12-16.
10. Libina, A.V. (2008). Sovladajushhij intellekt: chelovek v slozhnoj zhiznenoj situacii. – M.: Jeksmo. – 400 p.
11. Medvedskaya, T.S. (2009). Aktivnost' lichnosti: strukturnye komponenty i osobennosti ih projavlenija // Vestnik universiteta (Gosudarstvennyj universitet upravlenija), 34, 65–66.
12. Medvedskaya, T.S. (2010 a) Vzaimosvjaz' tolerantnosti lichnosti i osobennostej psihologicheskoj adaptacii kitajskih studentov // Vestnik RUDN. – Serija: Psihologija i pedagogika, 1, 89–93.
13. Medvedskaya, T.S. (2010 b). Strukturno-funkcional'naja model' aktivnosti lichnosti. Vestnik universiteta (Gosudarstvennyj universitet upravlenija), 15, 48–50.
14. Pilishvili, T.S. (2012). Osobennosti junosheskikh predstavlenij ob aktivnosti lichnosti v sovremennyh kommunikacionnyh uslovijah // Nauchno-prakticheskij zhurnal «Akmeologija». Special'nyj vypusk po materialam akmeologicheskikh chtenij, posvjashhennyh 20-letiju kafedry akmeologii i psihologii professional'noj dejatel'nosti 21 nojabrja 2012, 3, 269–273.
15. Pilishvili, T.S., Chkhikvadze, T.V. (2012). Sbornik materialov otechestvennyh i zarubezhnyh avtorov po probleme aktivnosti lichnosti v sovremennom obshhestve [Tekst] : nauchnoe izdanie – M.: RUDN, – 82 p.
16. Ryan R., Deci E. (2001). On happiness and human potential // Annual Review of Psychology, V. 51, p. 141–166.
17. Stefanenko, T.G. (2000). Jetnopsihologija: uchebnik dlja studentov vuzov po special'nosti «Psihologija». – Ekaterinburg: Delovaja kniga. – 320 p.
18. Frankl V. (1993). Life With Meaning.- Brooks/Cole Pub.- 189 p.
19. Rubinshtejn S. L. (2000). Osnovy obshhej psihologii - SPb: Izdatel'stvo «Piter». - 712 s.
20. Kronik A.A. (1998). Psihologija chelovecheskih otnoshenij. – Dubna: Feniks; M.: Kogito-Centr. – 214 s.
21. Kolesnikova T.I. (2003). Mir chelovecheskih problem: psihologicheskaja koncepcija zdorov'ja. – M. VLADOS-PRESS. – 208 s.
22. Osuhova N.G. (2007). Psihologicheskaja pomoshh' v trudnyh i jekstremal'nyh situacijah.- M.: Akademija. – 284 s.
23. Seligman M. (2011). Learned Optimism. - Random House Australia.- 336 p.



*Overview of conflict occurring in Youth-Headed Households (YHHs) of siblings in  
Rwanda*

Immaculée Mukashema

National University of Rwanda

0083

The Asian Conference on Psychology & the Behavioral Sciences 2013

Official Conference Proceedings 2013



iafor

iafor  
The International Academic Forum  
[www.iafor.org](http://www.iafor.org)

## **1 Introduction**

### **1.1 Youth-Headed Households (YHHs) of Siblings**

Rwanda considers a double orphan is a child who has lost both parents (MIGEPROF 2008). Rwanda has a large number of orphans resulting from the combined effects of the 1994 genocide and the HIV/AIDS epidemic. The genocide of 1994 has left Rwanda with a significant number of children who have no relatives (Boris and al. 2006, UNICEF 2007). Twenty per cent of the Rwandan population under 21 are orphans. At the Rwanda national level, double orphans are 2.7% (NISR 2012).

With the decline in the traditional foster care system, a new phenomenon emerged whereby young people are heading households as a “family” without parents. The oldest sibling becomes the head of the household and fulfils the responsibility of caring for the younger siblings (UNICEF 2001; Schaal & Elbert 2006). Siblings living in Households headed by youth (YHHs) are common in Rwanda. These siblings in YHHs form a “family” that provides support and continuity (McAdam-Crisp (2006). They deal with the adult responsibilities of supporting themselves at an age when the care and the protection of an adult are normally needed (Schaal & Elbert 2006). They assume an anthropological and psychosocial position for which they were never prepared (Boris & al. 2006). YHHs are a new phenomenon of alternative family as a symbol of a social safety that is breaking down (Roalkvan 2005) shown by the increasing of double orphans without relative in Sub-Sahara Africa (UNICEF 2006; Barnet 2005). Young person are those considered as such by the society (African Union 2006). In Rwanda, the “youth” is made up of persons aged between 14 and 35 years old (NISR 2010/2011). However, this study looks at people who are in Household sibling-headed in Rwanda. Rwanda has 2.7% of double orphans within the twenty per cent of the Rwandan population under 21 years old who are orphans (NISR 2012).

### **1.2 Conflict between siblings and YHHs**

Conflict does not occur only between husband and wife. It may also occur between siblings (Malek 2010). Conflicts between siblings living with parents have been studied. Some studies investigate conflicts between siblings in terms of conflict frequency and conflict management strategies (Howe et al. 2002; Furman & Buhrmester 1985). There are studies of the situation of orphaned siblings and YHHs in Sub-Sahara, Eastern and central in general and in Rwanda in particular (e.g. Foster & Williamson 2000; Ntaganira et al. 2013; Ntaganira et al. 2012; Thurman et al. 2006; Boris et al. 2006; Uwera & Brackelaire, 2012/2 ; Schaal & Elbert 2006; Smart 2003; UNICEF 2007 ; UNICEF 2001; UNICEF 2000 etc.). However, none of these studies focused on the issues of conflict/dissension in YHHs.

Little known about how young people manage the sibling caring responsibilities after the death of their parents (Evans 2010). The functioning of YHHs is not well known (Uwera & Brackelaire 2012/2). Also little is known about conflict/dissension among siblings living in YHHs and there are important differences between YHHs and other family forms. (1) Siblings' life in YHHs is different from life in traditional families because when there is conflict between siblings lives in traditional families, parents

can intervene as adults. (2) YHHs are obliged to live together and to continue the life started by their parents, without their personal agreement at the time of their family foundation. (3) Spouses in traditional families choose freely to get married and live together, while the YHH does not involve choice by all parties. (4) The head of YHH lacks the moral authority and public support of the parental role. ‘You should obey your father’, but no-one says you should obey your brother or your sister.

The present research intend to investigate on what happen in terms of conflict/dissension between siblings living on their own in YYHs as a new kind of “alternative families” (Bartoszuk & Pittman 2010). It is attempting to answer the following questions: (1) is there conflict/dissension in YHHs in Rwanda? (2) What are the causes; (3) what are the consequences; (4) how do YHHs feel when conflict/dissension occurs? (5) What strategies do YHHs use to face conflict/dissension; (6) what can be done to help the families headed by young people for a healthy life in YHHs?

## 2 Methods

A qualitative approach was selected because (a) little is known (Grenier 2005) about conflict/dissension in YHHs; and (b) it allows an overall holistic interpretation which permits the social significance of the data to emerge (Deslauries & Mayer 2000).

### 2.1 Field, population of the study and selection of participants

This research was done in Huye District, in its four administrative Sectors: Ngoma, Mbazi, Gishamvu and Rwaniro. Huye is one of the Districts of the Southern Province in Rwanda. In Huye District, like other Districts of Rwanda, the population is young (NISR, 2012). Huye District has 3% of double orphans among the population aged 0-20. We conducted seven Focus Groups Discussions (FGDs), composed of double orphans who were heading households of siblings and who agree freely and voluntary to give information about conflict/dissention in their homes. Selection and recruitment of participants was facilitated by the local administration in collaboration with two NGOs called respectively “Association Modest et Innocent (AMI)” and “Igiti cy’Ubugingo Centre (IUC)”. These two NGOs work with, double orphans living in YHHs in the four administrative sectors. These four administrative sectors are in rural area. The data collection was done between December 2012 and January 2012. Participants were separated into FGDs by gender, and numbers in the groups ranged from 4-12. Table 1 shows the FGDs’ Composition.

*Table1. Structure and characteristics of FGDs and other socio-demographic characteristics*

Ide ntifi cati on of the FG D	Gen der of the mem bers of FGD	Age of the partici pant (Head of the HH) in FGD	Num ber of the FGD mem bers	Rang e of the FGD’ Mem bers	Numb er of sibling memb ers of the YHHs in	Range of age of the YHH’ Memb ers	Period headed HH/liv ed in YHHs (years)	Rang e of mont hly inco me estim ations (Frw)
-------------------------------	--------------------------------	---	-----------------------------	-----------------------------	--	-----------------------------------	---	---

					addition to the Head of the HH			USD 1 = c. Frw. 650
11	Male	19	6	17-26	1	17	12	< 10,000
		20			3	16;12;6	4	< 10,000
		21			2	19;4	8	< 10,000
		24			4	17;14;7	4	< 10,000
		26			2	22;20	3	< 10,000
		17			2	14;12	4	< 10,000
21	Female	28	7	17-31	7	26;24;22;20;18;16;14	18	< 10,000
		31			6	25;18;14;10;8	17	< 10,000
		22			4	19;16;12;9	2	< 10,000
		23			3	21;17;14	2	< 10,000
		17			5	16;13;11;10;3	2	< 10,000
		23			1	21	4	< 10,000
		21			2	17;11	5	< 10,000
31	Female	Missing information for one FGD's member						Rang

		24	6	21-29	1	20	2	e 10,00 0- 30,00 0
		21			2	19;17	5	< 10,00 0
		21			1	19	4	< 10,00 0
		29			3	22;19; 4	4	< 10,00 0
		24			1	20	3	< 10,00 0
41	Male	17	4	17-21	1	16	3	Rang e 10,00 0- 30,00 0
		20			1	18	4	Rang e 10,00 0- 30,00 0
		21			1	19	1	Rang e 10,00 0- 30,00 0
		21			2	20;11	17	Rang e 10,00 0- 30,00 0
51	Fem ale	24	6	17-24	3	22;20; 16	2	< 10,00 0
		20			4	18;16; 14;12	9	< 10,00 0
		20			1	17	9	<



								10,000
		17			2	14;12	1	< 10,000
		23			3	20;11;9	6	< 10,000
		17			2	15;12	1	< 10,000
61	Female	19		18-30	1	16	1	Range 10,000-30,000
		30			3	28;22;20	17	Range 10,000-30,000
		20			2	18; 16	9	< 10,000
		20			3	13;12;7	3	< 10,000
		21			6	19;18;15;13;11;9	4	Range 10,000-30,000
		18			2	14;12	4	< 10,000
71	Male	25	6	22-28	2	20;18	17	< 10,000
		28			1	18	15	< 10,000
		24			4	20;18;18;16	13	< 10,000
		22			4	17;15;7;5	4	< 10,000

						0	
		22		1	20	17	< 10,00 0
		27		2	21;16	6	< 10,00 0

Many of them were less than 18 when their parents died and thus started to head household (Thurman et al. 2006; Ward & Eyber 2009). The size of the YHHs ranged from 2 to 8 including the participant in the FGD. The age of the other YHHs members apart from the head ranged from 3 to 28. The time of life without parents ranged from 1 year to 18. Participants aged 21 constitute the majority (7/41) followed by those who are aged of 20 (6) and by those who are aged of 24 and 17 (5/41) respectively. The majority of participant said they have an income of less than 10,000 Rwandan francs per month (less than about fifteen US dollars). However, there are difficulties with the concept of income in predominantly agricultural countries and those living on subsistence agriculture may not be good at computing the value of their produce.

## 2.2 Research approach

Two moderators including the main investigator and two assistants were recruited. They underwent two days of training on how to conduct FGDs and on ethics in research with human being as participants. A guiding Agenda related to research questions in Kinyarwanda the national local language was the tool used for FGDs. An informed consent was signed by each participant. Authorization to start and to record the discussion was obtained in the whole FGDs (Barnett 2002). Parallel sessions were conducted at each selected place – one for each gender, separately. Each session had a moderator and an assistant. To promote a relaxed environment during the FGDs sessions participants were given a soft drink as refreshment. At the end of each FGD session, participants were financially compensated by receiving 1500 RFWS (about two US dollars) for the day spent in travelling to the place of discussion and the time spent in the FGDs.

## 2.3 Data analysis

The method of data analysis was inspired by content analysis (L'Écuyer 1989). All seven tapes from seven FGDs transcribed which gave a corpus of 94 pages, and were translated from Kinyarwanda into English. The Kinyarwanda and English versions have been read many times by the main investigator; to 'absorb the content' (Baribeau 2009). The coding was done using nVIVO software (Duchesne & Haegel 2005). Following the research questions as guides, every line, paragraph, and/or section of text was given a specific code. The data analysis moved in a circle between the data and the analysis (Glaser & Strauss 1967; L'Écuyer 1989; Paillé 1994; Baribeau 2009). The process continued until no new code emerged.

## 3 Results and Discussion

### 3.1 Existence and signs of conflict/dissension in YHHs

Conflict/dissension does exist in YHHs. Its main signs are

- the absence of positive interaction between household members and poor communication;

- the misbehaviour and lack of respect between siblings in the household;
- property management and sharing resources and responsibilities;
- the lack of sufficient land and hunger;
- lack of obedience to the head of the household

The unwanted pregnancy of ten girls who had left home but came back intensified the existing conflict in the sibling YHHs.

The lack of agreement on issues related to property left by the parents, such as the lands, the cows; the disagreement in sharing out of property that was held in common in the YHH—when one of the members gets married is also cited to be the cause of conflict/dissension. Siblings members of YHHs are victims of poverty and of hunger that stop them from getting on well in an easy way. YHHs are not able to satisfy the basic needs of their members. In terms of responsibility sharing, it is not only the head (who has to play the parental role) who is responsible for getting household needs met; each sibling member of the YHH who is able to do so needs to make a contribution. In the YHHs as well as in other kind of families, the failure to take responsibilities is a source of conflict/dissension.

### **3.2 Consequences which rise from conflict/dissension in YHHs**

Consequences of conflict/dissension in YHHs, as in other families, include the leaving home and the break-up of the family, health problems, and poverty.

In case of conflict/dissension, some sibling members of YHHs do not try to deal with it but leave the home. Leaving home may be aimed at searching for better living conditions, but this may end in failure. This failure can be translated, for a girl, into getting an unwanted pregnancy.

The consequence of conflict/dissension in YHHs may be mental suffering and drug abuse. Drug abuse as a refuge may lead to or itself constitute health problems expressed in mental suffering and in physical illness. In situation of conflict/dissension in YHHs, if members are not fully capable of work this leads to poverty.

### **3.3 Feelings of heads of household when conflict/dissension is present in YHHs**

A variety of feelings and emotions were reported by the heads of household participating in this research. They are related to psychological distress, to social isolation from neighbours and from the support of the authorities' support, to neighbours who made the conflict between siblings worse, to lack of motivation, and to suicidal thoughts and negative sentiments about them as heads of household.

YHHs living in conflict/dissension make their heads feel stressed, discouraged and abandoned by a society that does not care about them. Some felt like abnormal people. Other people do not worry about their lives and they feel the lack of someone, neighbours or authorities, to approach for comfort. They reported that when they need to talk to authority, they feel afraid to approach it. They feel abandoned, socially isolated. In turn, because of the feeling of the social isolation, they prefer to keep quiet and do not tell anyone about their conflict-related problems. Participants reported that in case of conflict/dissension in their family, the neighbours do not help to solve conflict, but instead say things to the elder or younger brother of the head that

are intended to worsen the situation. This is consistent with the assertion that some neighbours can act spitefully toward the young heads of households. They feel the lack of motivation to deal with their responsibilities. They have no motivation to work and may fall into depression in evaluating their previous actions are not effective.

Sometimes sibling members of YHHs living in conflict/dissension have thoughts of committing suicide. This is due to conflict but also this may be linked to the situation of social isolation, negative emotionality and depressive symptoms. Some YHHs members decide to go far away from their siblings in case of conflict/dissension in their families. The unhealthy situation of conflict/dissension can lead the heads of YHHs to feel regret at being the eldest of the family, as they feel fear to approach the authorities to speak about their problems.

### **3.4 Means or strategies used by YHHs to face conflicts/dissensions**

In order to face conflict/dissension, participants reported sharing with peers and people of the same age and the same experience, their own friends or a parent's friends. YHHs call upon specified categories of people to help them with conflict/dissension. They mainly prefer to talk to people with the same experience of conflict/dissension and other young people, their peers, for sharing experience and mutual help in finding solutions, rather than having recourse to elder people. When heads of sibling households enter into conflict/dissension, they can go to their own friends or the friends of their dead parents and ask them to intervene with their advice. In conflict/dissension situations, they would be willing to search for help in the extended family - an aunt or uncle but in general such family members no longer exist.

### **3.5 Needs in relation to conflict/ dissension between siblings in the YHHs**

YHHs expressed themselves on what they think can be done in order to help sibling-headed families so that they no longer live in serious conflict/ dissension. What they need are economic assistance, and psychosocial support. Participants need economic assistance to be helped to come out of poverty. They need to be approached by counsellors and advisers and they need advocacy. Heads of household said that they needed advice, counselling, advocacy and adult guidance. They need to be approached regularly by leaders, neighbours and friends. This can help them, especially to those who are very young yet, to overcome the lack of role models, as they put it. It would also help to deal with the feeling of be marginalized within community structures.

### **3.6 Actions to be taken**

There is an urgent need for siblings in YHHs to be specifically approached by counsellors and advisers and an urgent need for advocacy. Mentoring intervention is relatively low cost, and it has been shown to be effective in varying settings (Dubois et al.2002). Successful mentoring programs may also help to renew social interconnectedness in Rwanda (Boris et al. 2006).

Specific structures may need to be put in place to deal with all YHHs issues in their daily life and regulation. Judging from this research, it seems to be very important to set up laws recognizing the existence of YHHs, legislating their rights and duties in the same was as the laws covering other kinds of family and dealing with YHH

property. In a country that has a high number of YHHs (UNICEF 2009; Lee 2012) that will probably go on increasing because traditional foster care is declining.

This research suggests that it could be important to set up a national and specific structure that may deal with all YHHs issues in their daily life. The specific structure should go with setting up a special channel of effective advocacy for YHHs. There is no specific institution for YHHs; YHHs do not have anywhere where they can find specific advocacy (Clinique Juridique 2003); to put it in place would help support YHHs in solving their daily difficulties, including those related to conflict/dissension, and their consequences for the healthy life.

These YHHs constitute a new kind of alternative family with a new and specific structure, and members are special in terms of social and demographical characteristics, that need official recognition and the rights associated with that recognition. The specific structure and special channel to deal with YHHs issues would need a specific regulation giving to the same rights enjoyed by normal or traditional family. These will enable siblings in YHH families to have the same entitlement to socio-economic support -e.g. V2020 *Umurenge* program (this is one of the strategies programs to fight against the poverty in Rwanda) - as 'normal' families, and thus to come out of the poverty that is one of the causes of conflict/dissension.

YHHs should have training in family responsibilities. As there are roles that are played in the YHHs as alternative families, it would be good to offer special education about parenthood and about family management in general, especially to the heads of the YHHs.

The main aspects - signs, causes, and consequences - of conflict/dissension are present even in traditional families and in other types of alternative families. The YHHs in general and those living in conflict/dissension are different, however, in that no adult member of any other family will say that he/she needs "adult support" to solve their problems related to conflict/dissension. This means that they are aware of their weaknesses as young people. On the other hand, they have demonstrated their capacity to cope with life events and, through that, their resilience in the face of unfavourable situations such as being orphan, and not only an orphan, but an orphan without adult presence in their family life.

### **Acknowledgement**

*I am very grateful to the National University of Rwanda (NUR) in general, to the NUR's Research Commission and Sida Sarec in particular, for the financing of this research.*

*Many thanks also to Prof. Roger Sapsford for his assistance.*



## References

- African Union, 2006. *African Youth Charter: The seventh ordinary session of the Assembly of African Youth Charter*. Gambia : African Union.
- Baribeau, C., 2009. Analyse des entretiens de groupe. *Recherches qualitatives*. 28 (1), 133-148.
- Barnet, T., 2005. HIV/AIDS, childhood and governance; sundering the bond of human society. *African Journal of AIDS Research*. 4(3), 173-182.
- Bartoszuk, K., & Pittman, J. F. (2010). Does family structure matter? A domain specific examination of identity exploration and commitment. *Youth and Society*. 42, 155-173.
- Boris, N.W., Thurman, T. R., Snider, L., Spencer, E., & Brown, L., 2006. Infants and Young Children Living in Youth- Headed Households in Rwanda: Implication of Emerging Data. *Infant Mental Health Journal*. 27 (6), 584-602.
- Clinique Juridique of the National University of Rwanda ,2003. *Irengera ry'abana b'Imfubyi mu mategeko mbonezamubano y'u Rwanda*. Butare.
- Deslauriers, J.P., & Mayer, R., 2000. L'observation directe. Dans R. Mayer, F. Ouellet, M-R., St-Jacques, D., Turcotte , et call. *Méthode de recherche en intervention sociale* (pp. 135-158). Montréal: Gaëtan Morin éd.
- Dubois, D.L., Holloway, B.E., Valentine, J.C., & Cooper, H., 2002. Effectiveness of mentoring programs for youth: A meta-analytic review. *American Journal of Community Psychology*. 30(2), 157-197.
- Duchesne, S & Haegel, F., 2005. *L'entretien collectif*. Paris: Armand Colin.
- Foster, G., & Williamson, J., 2000. A review of current literature on the impact of HIV/AIDS on children in sub-Sahara Africa. *AIDS*. 14 (Suppl. 3), S275-284.
- Furman , W., & Buhrmester, D., 1985. Children's perceptions of the qualities of sibling relationship. *Child Development*. 56, 448-461.
- Grenier, S., 2005. Paradoxe et opportunité de la recherche qualitative en santé mentale communautaire. Recherches qualitatives- Hors- Série- Numéro 1. *Actes de colloques Recherche Qualitative et production des savoirs*. UQAM, 12 mai 2004.
- Glaser, B. G., & Strauss, A. L., 1967. *The discovery of grounded theory: Strategies for qualitative research*. Chicago: Aldine Publishing Company.
- Howe, N., Rinaldi, C.M., Jennings, M., & Petrakos, H. ,2002. "No! The Lambs Can Stay Out Because They Got Cozies": Constructive and Destructive Sibling Conflicts, Pretend Play, and Social Understanding. *Child Development*. 73 (5), pp. 1460-1473.
- L'Écuyer, R., 1989. L'analyse développementale du contenu. *Revue de l'Association pour la Recherche Qualitative*. 1, pp.51-80.
- Lee, L., 2012. Strategies to support youth-headed household in Kenya and Rwanda. *Bacgrounder*. 43.
- Malek , C. ,2010. *Family Conflict*. Boulder: University of Colorado.
- McAdam-Crisp, J.L., 2006. Factors That Enhance and Limit Resilience for Children of War. *Childhood*. 13(4), pp.459-477.
- Ministry of Gender and the Promotion of Familiy, 2008. *A Situation Analysis of Orphans and Other Vulnerable Children in Rwanda*. Kigali: Government of Rwanda. Available from <http://www.dol.gov/ilab/programs/ocft/20090602/rwanda08.pdf> .
- National Institute of Statistics (NISR), 2010/2011. *EICV3 Thematic Report Youth*. Kigali: NISR.
- National Institute of Statistics of Rwanda (NISR). ,2012. *The third Integrated Household Living Conditions Survey (EICV3)-Main indicators Report*. Kigali: NISR.

- National Institute of Statistics of Rwanda (NISR). (2012). *The third Integrated Household Living Conditions Survey (EICV3) District Profile - South – Huye*. Kigali: NISR
- Ntaganira, J., Brown, L., & B Mock, N.B., 2013. Results of a Community Mentoring Programme for Youth Heads of Household in Rwanda: Effects on Youth Sexual Risk Behaviors and Maltreatment. *Rwanda j. health sci.*, 2(1).
- Ntaganira, J., Brown, L., & Mock, N.B. ,2012 . Maltreatment of Youth Heads of Households in Rwanda. *Rwanda Journal of Health Sciences*.1.
- Paillé, P.,1994. L'analyse par théorisation ancrée. *Cahier de recherche sociologique*. 23, pp.147-181.
- Roalkvam, S., 2005. The children left to stand alone. *African Journal of AIDS Research*. 4 (3), pp.211-218.
- Schaal, S., & Elbert, T., 2006. Ten Years After the Genocide: Trauma Confrontation and Posttraumatic Stress in Rwandan Adolescents. *Journal of Traumatic Stress*, 19(1), pp.95-105.
- Smart, R.,2003. *Policies for orphans and vulnerable children: a framework for moving ahead*. Washington, D.C., Futures Group International, POLICY Project, USAID.
- Thurman, T., Snider, L., Boris, N., Kalisa, E., Mugarira, E., Ntaganira, J., & Brown, L.,2006. Psychosocial support and marginalization of youth-headed households in Rwanda. *AIDS Care: Psychological and Socio-medical Aspects of AIDS/HIV*.18(3), pp. 220-229.
- Thurman, T.R., Brown, L., Richter, L., Maharaj, P., & Magnani, R.,2006. Sexual Risk Behavior among South African Adolescents: Is Orphan Status a Factor? *AIDS Behavior*. 10, pp.627-635.
- UNICEF.,2009. Rwanda background. Retrieved in February 2013. Available from [http://www.unicef.org/infobycountry/rwanda\\_1717.html](http://www.unicef.org/infobycountry/rwanda_1717.html).
- UNICEF,2007. Une aide pour les orphelins du Rwanda. Available from [http://assets.unicef.ch/downloads/fsheet\\_ruanda\\_050725\\_fr\\_neu.pdf](http://assets.unicef.ch/downloads/fsheet_ruanda_050725_fr_neu.pdf).
- UNICEF, 2006. *Africa's Orphaned and Vulnerable Generations: Children affected by AIDS*. Available from [http://www.unicef.org/publications/files/Africas\\_Orphaned\\_and\\_Vulnerable\\_Generations\\_Children\\_Affected\\_by\\_AIDS.pdf](http://www.unicef.org/publications/files/Africas_Orphaned_and_Vulnerable_Generations_Children_Affected_by_AIDS.pdf).
- UNICEF,2000. *Struggling to survive: Orphan and community dependent children in Rwanda*. Kigali,: UNICEF.
- UNICEF, 2000. MINALOC- *Ministry of Local Government and Social Affairs: An in-depth assessment into the situation of orphans in Rwanda*. Kigali: UNICEF.
- Uwera K.C. & Brackelaire, J.L., 2012/2. La fratrie dans les ménages d'enfants sans parents au Rwanda après le génocide . *Dialogue*. 2(196).
- Ward (Lee), L.M., & Eyber, C., 2009. Resilience of children in child-headed household in Rwanda: implication for community based psychosocial interventions. *Intervention*. 7(1), pp.17-33.

*Risk Management for the Future: Age, Risk, and Choice Architecture*

Orly Lobel, On Amir

University of San Diego, USA

0106

The Asian Conference on Psychology & the Behavioral Sciences 2013

Official Conference Proceedings 2013

Abstract

How can regulation in an era of personal responsibility aid people to make the optimal decisions about their future risks, savings, and retirement? This study aims to deepen our understanding of how different age groups process choices in relation to future risk and retirement planning in diverse decision-making environments. In a series of experiments, we examine how age and the life cycle interact with the decision-making environment concerning savings, retirement and well-being. Across multiple experiments we find that when cognitive resources are available older participants opt for more prudent financial and retirement choices, but that this pattern does not hold in situations that do not allow the luxury of executive control override. Moreover, in some instances, we find an increased effect of resource depletion for older compared to younger participants. At a theoretical level our findings suggest that much of the difference in financial choices between older and younger decision makers rests in the ability of each age group to override their intuitive and automatic responses to such decisions. At the policy level, as the regulatory field is moving from command-and-control rules to the provision of menu options and choice architecture, our findings provide potential guidelines for better designing retirement and savings plans, such as the implementation of SMT-style programs and the encouragement of annuity over lump sum retirement benefits.

Keywords: Decision making, Risk, Aging, Retirement, Executive Resources

## I. Introduction

In the midst of an unsteady economy, many individuals approaching retirement age are discovering that their savings and safety nets are not nearly enough to see them through old age. As the menu of choices pertaining to prolonging quality of living and life spans continues to expand, individuals find themselves struggling with the planning of their future financial and general well-being. While these decisions are increasingly privatized, the decision-making environment is created by law and policy and is the subject of on-going public debate. In particular, policymakers now face the challenge of improving individual risk planning through choice architecture, information and design. The field of behavioural judgement and decision-making thus provides opportunities to better direct behaviour through policy design rather than through command-and-control. In particular, the novel experimental tool of cognitive depletion provides new ways to examine how the decision-making environment – the background conditions under which individuals make choices – affect different age groups in their future planning. It allows us to look beyond the existence of irrationalities, bounded rationality and biases, into the mechanisms and sources of decision-making processes. This article sets out to enrich the body of knowledge in the field to provide for better predictions of when and how people will choose to act for a more secure financial future. This article uses a behavioral lens of cognitive resources and executive controls to examine recent policy debates about pension reform.

In a series of experimental studies, we examined the effect of age on choices regarding future savings and enrollment, and selection between pension and medical insurance coverage options. Using new experimental techniques to manipulate executive control resources, we investigated the interactions between the various mechanisms that affect these decisions and the level of processing decisions: intuitive vs. controlled (or automatic vs. deliberative) evaluation. Our findings show significant differences between participants along age groups and important interactions between decision-making states, i.e. level of cognitive resources, and optimal future risk planning. In general, the findings reveal an increase in risk aversion in older age, contributing to an on-going debate in the literature about the effect of age on risk. More surprisingly, our findings reveal complex interactions between risk processing and cognitive states, which vary between types of decisions and age categories. Across these multiple experiments we find that when cognitive resources are available older participants opt for more prudent financial and retirement choices, but we also find that this pattern does not hold in situations when people are depleted, suggesting the variation along age lines in financial planning is often sourced in the ability of people to cognitively override (System 2) their initial automatic (System 1) decision-making processing. Moreover, in some instances, we find an increased effect of resource depletion for older participants compared to younger participants.

The article proceeds as following. Section II first introduces the present trend towards individual decision making in financial and future risk planning and the ways in which individual risk processing often fails to reach optimal results. Section III presents the design and method of the experimental studies along with the main findings in each of the experiments. Section IV provides a general discussion of the findings in relation to the behavioral field and relates the findings to contemporary policy implications, including the implementation of Save More Tomorrow (SMT)

style programs, the encouragement of annuity receipt in retirement plans, and the setting of decision-making environments that enable more prudent and rational financial planning. Section V concludes with an eye to the future of the research axes of cognitive resources and risk processing research.

## **II. The Rise of Individual Choice in Future Risk and Retirement Planning**

In many countries, the future landscape of financial planning has been altered substantially in recent years by intertwining developments in legal regulations, economics, and technological advances. In general, the shift has been toward individual decision-making (Hacker, 2011). In the regulation of pensions, similar to the regulation of health and other aspects of individual well-being, the past few decades have signified a growing expectation that people are autonomous decision-makers. Moreover, individual decision-making has become a political ideal advocated across many continents and political ideologies (Amir and Lobel, 2012; Burgess, 2012). At the same time, the shift from regulatory command-and-control to a regime of consumer choice presents an acute need to understand how individuals process information and decide between menus of possibilities under varying background conditions, whether it occur in the realm of savings, pensions, health insurance or medical treatments. In the area of retirement planning and pensions this challenge is particularly pressing given the reality that contemporary choices are frequently suboptimal and prone to multiple judgement and decision-making failures.

In the regulation of retirement plans and pensions, the United States Congress initially passed the Employee Retirement Income Security Act (ERISA) in 1974 requiring employers to offer plan participants diversified investment choices, while also allowing participants to switch regularly from one option to another. Notably, the Congressional debates regarding the passage of ERISA expressed reservations about exactly how much freedom was available to employees (Lawrence, 2003). Congress anticipated that the Department of Labor would address the risk of too much choice through regulation. These expectations have yet to fully materialize in practice and there is ongoing controversy over the optimal policy design to encourage pension enrollment and saving (Bicksler and Chen, 2012; Rothman, 2001).

In general, the shift has continued to be toward increased individual choice. In the past three decades, defined contribution plans have gradually replaced defined benefits plans, the former becoming the more common form of retirement savings plan (Stabile 2007; Dulebohn, 2002; Choi, 2002). Under the traditional defined benefit form, an employer would typically guarantee a fixed amount of income upon retirement for its employees and financial professionals subject to certain fiduciary standards that would control the financial decisions for the investments (Stabile, 2002). Under defined contribution plans, employers do not guarantee the individual employee a fixed sum upon retirement. Employers are less involved with the retirement plan decisions, and the individual employee must take more control over investment decisions. In the 21<sup>st</sup> century, defined contribution plans are more practical and affordable for employers to offer employees than defined benefit plans. Increased employee mobility coupled with longer life expectancies makes transferability a practical component of savings plans for employees (Venhorst,



2006). Defined contribution plans are much easier for an employee to transfer from one employer to the next in the event of a job change (Lobel, 2006). At the same time, the shift marks a deepening of individual self-accountability, making “workers increasingly responsible for providing for their financial security in later life” (O’Neill, 2007; Dulebohn, 2002).

The trend toward individual responsibility presents a different set of challenges for employees. Most generally, people do not save at the needed level to maintain their standard of living during retirement. Recent data compiled by the Federal Reserve indicates that the median household headed by someone aged sixty to sixty-two has a 401(k) retirement savings account with merely one-fourth of the savings necessary to maintain their standard of living in retirement (Browning, 2011).

In reaction to the low levels of pension enrollment and contribution, Congress enacted the Pension Protection Act (PPA) with strong bipartisan support in 2006. The PPA is the most significant pension reform legislation in recent years since the passage of ERISA in 1974. One of the most important features of the PPA is the promotion of automatic enrollment as a default, and the escalation of contribution rates, again as an automatic default, increasing savings over time. The default contribution rate must be 3% or higher to begin with and escalate by 1% each year until reaching a rate of at least 6% and a maximum of 10%. The legal incentives under the Act to adopt this design are significant, including exemption from annual non-discrimination testing. The PPA further allows employees to get investment advice from interested parties. According to then Secretary of Labor Elaine Chao, this goal is intended to prevent employees from being “overwhelmed by investment choices or paperwork,” and to “boost retirement savings by establishing default investment for these workers that are appropriate for long term [retirement] savings.” (Chao, 2006). However, even though the PPA has made significant progress to promote employee knowledge about their own investments and the adoption of automatic enrollment and automatic increases in contribution, pension savings continue to be suboptimal. Policymakers and practitioners in the field of savings and retirement continue to search for a better regulatory design that will bring individuals to a healthy level of financial planning for future risk and aging, including optimizing tax incentives, encouraging automatic enrollment defaults and other program innovations that will increase participation and savings. A current popular proposal for reform that purportedly addresses the behavioral failures that prevail in savings is that of Save More Tomorrow Program (Benartzi and Thaler, 2004). The idea is to offer people a savings program that, rather than start immediately, will start with a certain delay and will increase as time passes.

The experiments in our studies aim to aid and advance these developing attempts to improve retirement planning by contributing to our understanding of the perils and promises of varying decision-making environments. Under the influence of policy and public opinion, decisions about future risk are frequently not singular decisions. As required by ERISA, for example, an individual could revisit his or her retirement plan several times a year. Similarly, one could theoretically periodically revisit their savings portfolio, their health insurance, or their medical regimen. At the same time, the behavioral field provides explanations as to why initial decisions exhibit inertia, carrying substantial weight and impacting the likelihood of future switch. Many individuals stick very closely to their first decisions, such as those decisions regarding contribution levels to their retirement savings (Goldstein et. Al, 2008; O’Neill, 2007;

Frolik, 2010). Indeed, automatic enrollment defaults have become a paradigmatic example of how shifting defaults dramatically shift participation levels (Madrian and Shea, 2001). Information overload may further contribute to the problem of decision inertia: when an individual feels overwhelmed by the vast amount of information to be considered to make a new decision, they may avoid the decision and prefer to stay with the status quo rather than make an additional difficult decision (Davis, 2006). Individuals can become struck by “analysis paralysis” when overwhelmed by numerous choices for a difficult decision, and can be intimidated by the selection process (O’Neill, 2007). As one article warns, “today’s consumers are surrounded by abundant financial information, which makes many decision-making situations difficult. This information overload creates stress, anxiety, and tension to process information, resulting in difficulties in memorizing and remembering, and poor decisions” (Kim and Kim, 2010). Procrastination also exacerbates the problem of inertia. With regard to pensions, many individuals repeatedly avoid confronting the difficult decisions of changing their retirement savings funds, and simply put off making new decisions for long periods of time. Termed in the literature as *passive decision-making*, in reality even individuals who intend to make changes to their initial decision often fail to follow through on their intentions. One study found that of respondents who reported that they planned to increase their retirement contribution rate in the next few months because they thought their present savings rate was too low, only 14% followed through on their intentions by actually increasing their contribution rate in the following four months (Choi et al., 2002). Thus, many factors contribute to the importance of the initial decision as they may prevent individuals from revisiting their initial investment decisions for their retirement.

These growing lessons of behavioral economics point to the significance of initial policy designs that help individuals of all ages make prudent choices for the future. Put simply, because individuals have increasing control over their retirement, but are prone to make mistakes in judgment and decision-making concerning future risk and prone to stick with whichever choice they made initially, understanding how the background decision-making environment affects individual choice is particularly acute. How an individual makes choices about future risk has much to do with how that particular individual perceives the risk. A person’s financial risk tolerance is the amount of risk they are willing to incur when investing and saving for retirement. The converse of risk tolerance is risk aversion. It is well established in the literature that the two have a strong negative correlation within the same person, so that when one increases the other decreases (Faff et al., 2008). At the same time, there is growing evidence that the same person can be more risk tolerant or more risk averse in different contexts, situations and cognitive states. All of us are constrained by time, information, beliefs, and computational power.

Recent studies have shown that beyond the difficulties of processing and understanding information related to risk, emotions similarly play a critical role in apprehension of personal and societal dangers, and in turn can lead to snap judgments in place of considered, reflective assessments (Kahan, 2008; Huang, 2008). From a policy perspective, the need to understand failures in risk processing is of equal gravity as the processes and mechanisms that contribute to these choices. If, for example, as lawmakers, we become convinced that the reason for suboptimal pension enrollment is that people are generally irrational in their inability to evaluate future risk based on behavioral evidence, the law should opt for a more top-down risk

regulation. If, on the other hand, better decision-making environments can override the mechanism that led to suboptimal choices, policy can help design the background ecology surrounding individual choices.

Importantly, developments similar to the shift toward greater autonomy and individual choice have clearly taken place in other areas, such as the related field of health planning. In the regulation of future medical risk, laws mandating disclosures regarding side effects and risk warnings assume that people want to make decisions themselves and want to do so by gathering and evaluating information about their choices. The widespread availability of choice in health insurance selection similarly points to the perils of unchecked privatized planning. Mimicking the developments in pension and retirement planning, evidence demonstrates that individuals are not consistently or adequately equipped to make optimal decisions regarding their health and wellbeing, despite the rise in individual autonomy and choice. In the aptly titled article, *The False Promise of Consumer Choice*, for example, Deborah Stone argues against consumer choice in the context of healthcare and health management. In all of these risk planning contexts, because choices have become more autonomous, law and policy must delve into the behavioral to determine how choices can be supported to prevent people from making poor future plans (Amir and Lobel, 2012; Amir and Lobel, 2008; Feldman and Lobel, 2010). Analysis of inter-generational differences in judgment and decision-making is ever more important because, on the most basic level, our lives and environments simply demand more decision-making. Planning for future risk, retirement and wellbeing requires individuals to make a wide variety of choices on whether to opt for certain financial safeguards, how to weigh costs against benefits and how to process information about risk and chose among available options.

### **III. Study Design and Central Findings**

#### **A. Method, Cognitive Depletion, and Executive Resources**

The core of the study consisted of a series experimental lab studies where hypothetical cases were modelled on real problems and we manipulated the informational surroundings and background features in which the decision-making process took place. We asked individuals questions about their future risk management choices: We looked at decision-making in the context of savings, retirement, pension plans, financial investment, and insurance planning. In each of the experiments, we also added a dimension of resource depletion, a stage prior to the focal task, using a modified *Stroop Task*, as described below. The cognitive depletion manipulation was set to see whether performing unrelated tasks prior to the main decision-making one affects risk perception and subsequent decisions made (Pocheptsova et al., 2008; Feldman and Lobel, 2009; Amir and Levav, 2008; Amir and Ariely, 2007).

Choices about future risk are can be conceived as the result of the interplay of two systems: intuitive (System 1) and deliberative reasoning (System 2) (Amir and Lobel 2008; Frederick and Kahneman, 2002). Using cognitive depletion allows the observation of the interplay between the two systems. The underlying general hypothesis is that resource depletion has a systematic impact on choices, enhancing the role of intuitive System 1 by impairing the deliberate role of System 2 (Pocheptsova et al., 2008). Specifically, we examined the interplay of the two systems

when making future risky decisions by manipulating experimentally the availability of executive resources. A growing body of literature indicates that a seemingly unrelated activity that uses executive resources affects subsequent behavior (Muraven and Baumesiter, 2000). The literature shows that people's executive resources are limited and may become depleted by unrelated prior exertion. Further, when executive resources are depleted, the decision-making process is likely to rely more on intuitive processing. While the study of decision-making is an increasingly rich field, there remains uncertainty in the mental processes that leads to certain choices. Errors in decision-making arise from many sources and this study is designed to deepen our knowledge and offer novel insights of how such processes are relevant to retirement and future risk management. Relative to their importance, processing modes of risk have been understudied. In a series of recent and forthcoming studies, Amir and his collaborators test the nature of revealed preferences for, and aversion to, risk, arguing that these can be conceptualized as a temptation moderated by executive control processes. (Amir, et. al, 2012). Amir et al.'s findings demonstrate that resource depletion may lead to a preference for riskier options, and they hypothesize that risk aversion stems from similar mechanisms as self-control (or "self-regulation") and is subject to similar influences. While there are studies about connections between aging and risk, the interplay between age, risk-aversion and executive resources is still vague. Similarly, while there are many studies about the systemic ways people are affected by heuristics, such as choosing the middle option (compromise effects) or preference for inaction over action (status quo effects), there is still scarce study of whether such effects are mitigated or exacerbated by varying degrees of cognitive resources within different age groups.

## **B. Core Findings**

### ***i. Retirement Savings***

#### ***a. Method***

##### ***Participants***

Participants were 838 individuals (ages 18-80, average age = 31, StdDev = 11.1, Median age = 27, 50% female) in Amazon.com's Mechanical Turk, paid \$1 in return for participating in our study.

##### ***Design & Procedure***

The study had two conditions (Control vs. Depletion) in between subject design. Participants logged into the study and read instructions describing a reaction time task involving reading a name of a color printed in a font of a different color, and clicking the button describing the name of the color. In the control condition, participants had to click on the button designating the color written by the word (i.e., its semantic meaning) whereas in the depletion condition participants had to click on the button corresponding to the color of the font the word was written in. This setup represents a modified *Stroop Task* (Stroop, 1935; Pocheptsova et al., 2008), wherein the semantic interpretation of the word is primal and automatic, responding to the color the word is printed in requires cognitive override. The latter override process has been shown to deplete executive resources. Participants responded to 40 such screens, and then reached the dependant measures section that was identical between conditions. We also collected participants' demographic information, including age, at the end of the experiment.



### *Save More Tomorrow*

Building on the design of the Save More Tomorrow experiment (Benartzi and Thaler, 2004), we asked participants to: “Suppose you were currently contributing 3% a year to the company's saving plan for your retirement. If you are like most of your fellow employees, you think you should be saving more but never seem to get around to it. You often think, well, next year I'll save more but right now my budget is just too tight. Suppose that a new plan was designed with you in mind. The plan is offering you the option of deciding now to commit some of your future salary raises. For example, if you join and receive a 5% raise, some of it would go towards your savings increase, say to 5% automatically. Your take home pay will still increase, but slightly less than it would have without the plan. You will be saving more and you will pay less in taxes since contributions to the saving plan are tax deductible. The same thing would happen again the following year. It is likely that if you join the program now, you may never notice the difference in your take home pay, but in a few years you would certainly notice the difference in the amount of money you had saved for retirement. Of course, if you change your mind, you could always withdraw from the program and reduce the level of contributions you are making to the plan.” We then asked participants about the likelihood of them joining such a plan on a 5-point scale ranging from “Not likely at all” to “Very likely.”

### *Lump Sum vs. Annuity*

Participants were told that “Current retirement plans offer either a lump sum (i.e., you receive all the money you saved at once) or an annuity (i.e., you receive monthly payments over a long period of time. In the case of an annuity you continue to gain from accrued interest, so essentially you will get a larger total over the entire payment period.” They were then asked which of the two options they would rather have for their retirement.

### *Intertemporal Preferences*

In a fairly standard measurement technique (Kim, B. et. al, 2012) participants read the following instructions: “Imagine that you are about to receive a tax rebate worth \$1,200. Imagine that you have the option of receiving the tax rebate today, or waiting 9 months to receive a larger rebate instead. Please indicate whether you'd prefer to receive the money today, or to wait 9 months and receive more money.” We then offered a choice between receiving the \$1200 rebate now or receiving a larger sum, incrementally growing with each choice frame, ranging from \$1250 up to \$2000 dispersed within the span of 9 months. All participants saw the \$1250 option, and only those participants who chose the immediate \$1200 were asked about increasingly larger postponed sums, such that we find the point in which a participant becomes patient, in the sense that he or she chooses the larger delayed tax rebate rather than the immediate sum. In this way we could calculate their discount factor.

### *b. Results*

#### *Tax Rebate*

We will first analyze the time discounting results. As can be seen from the average linear effect in Table 1, the older a person is, the more willing they are to postpone rebate receipt, that is, they are willing to take a delayed rebate for a smaller dollar amount increment over the immediate sum. In other words, as people in the sample



grow older they become more patient with respect to money. However, the effect is actually curvilinear, as can be seen in the second model in Table 1, such that the younger and older people in our sample exhibit greater patience than the mid-group counterparts. An even closer observation of the differences between conditions, however, tells the complete story: we find a strong curvilinear effect when people are depleted, but no significant effect when they are not.

**Table 1**

	Linear effect	Curvilinear effect	Condition	
			Control	Depletion
Age	-1.9804 (2.06)	8.439726 (1.59)	-0.77617 (.1)	16.57786 (2.29)
Age <sup>2</sup>		-0.13754 (1.99)	-0.02603 (.25)	-0.23505 (2.51)
Constant	439.5349 (13.87)	265.3545 (2.85)	432.325 (3.14)	118.206 (.94)

t-values in parentheses.

*Savings decisions*

In order to assess the effect of age on both savings decisions, the decision to gradually increase savings rates over time (STM) and the decision to take the pension fund as a lump sum or annuity, we contrast how younger and older people choose in our sample. As the age distribution is neither symmetric nor normal, we use a median-split (median age was 27) to comparing the younger and older halves of our sample. Table 2 displays the mean values for each decision in each age group.

**Table 2**

	Save More Tomorrow		% Choosing Annuity	
	Younger <sup>b</sup>	Older <sup>b</sup>	Younger	Older
Control <sup>c</sup>	4.11 <sup>d</sup>	4.3 <sup>d</sup>	82% <sup>a</sup>	78%
Depletion <sup>c</sup>	4.14	4.22	76% <sup>a</sup>	74%

<sup>a</sup> Difference significant at  $p = .1$

<sup>b</sup> Controlling for individual heterogeneity in time discounting, older participants are more likely to opt in to the savings plan,  $p = .045$ .

<sup>c</sup> Depleted participants across ages are more likely to choose lump sum over an annuity,  $p = .08$ .

<sup>d</sup> Difference significant at  $p = .04$ .

As is evident in the table, we find a greater tendency to opt-in to a savings plan among older participants than younger participants. This effect does not apply if participants are depleted, as the older participants become less likely to opt-in than their non-depleted counterparts. The effect is large enough so that we still find an overall effect of the same nature.

We find no similar effects for the annuity decision. When it comes to the choice of an annuity or lump sum, we find that the younger participants are the most likely to choose the annuity, but that this incidence decreases when they are depleted, in line with an overall effect of a depletion-driven tendency towards the lump sum choice. A more basic result, but one that is worth paying attention to from a policy perspective,

is that in the frame of our experiment, where the choice between annuity and lump sum was not moderated by a default of one or the other, but where we told our participants that with annuity “you continue to gain from accrued interest, so essentially you will get a larger total over the entire payment period”, the majority of our participants across *all* conditions chose the annuity option.

### *c. Discussion*

We can summarize our findings as two sets of effects and the interactions between them: effects of aging and effects of cognitive resources. Our current set of findings suggests that as people age they become more patient, that is, they are willing to wait for a tax return, as well as increase their savings rates at the cost of immediate consumption. At the same time, the closer people get to retirement, they are less willing to give up a lump sum and opt for receipt of their pension fund as an annuity. We also find that depletion of cognitive resources makes people overall have less patience, causing younger people to be more likely to go for the lump sum over the annuity. We also find that the effect on the willingness to hold 9 months for an increased tax rebate is curvilinear: when depleted, it is the middle-aged person who becomes impatient, but both young and old become more patient. It is possible that the younger participants are more sensitive to the monetary increment, while the older participants' consideration of the potentially shorter life expectancy is a controlled one. Our findings further raise the question of whether some ages and types of decisions are more susceptible to the effects of cognitive depletion. Such specific instances help shed light on the decision processes underlying these cases. We discuss these questions below.

## ***ii. Future Investment and Insurance Choices***

### *a. Method*

#### *Participants*

Participants were 300 individuals (ages 18-68, average age = 34.4, StdDev = 11.93, Median age = 32, 53% female) in Amazon.com's Mechanical Turk, paid \$1 in return for participating in our study.

#### *Design & Procedure*

The study had two conditions (Control vs. Depletion) in a between subject design. Similar to the previous experiment, participants completed a modified *StroopTask* (Stroop 1935), either in the more depleting condition or in the less depleting one. They then proceeded to complete the two tasks described below. Task order was randomly assigned. Finally, we measured participant demographics, age being one of the items measured.

#### *Investment risk*

In this experiment, participants were offered a list of 10 investment choices in a sequential nature (fashioned after the Holt and Laury 2002, *Risk Preference Assessment Method*, Appendix I). Each investment decision offered two portfolios comprised of Stocks and Bonds. Participants were explained that “Stocks” meant high risk / high reward whereas “Bonds” meant low risk / low reward options. We measured the number of risky, as opposed to safe, options each participant made.

#### *Choice of Coverage in Insurance Plans*

In this task, participants were faced with a choice of 3 possible health insurance plans differing in quality and price, ranging from the cheapest with the least coverage to the most expensive and comprehensive plan. This task is an example of a decision situation with an implicit, as opposed to an explicit, risk implication. Choosing the

cheaper plan implicitly means taking greater financial risk over the foreseeable future. Participants were asked to choose the plan that best suited their preferences and needs.

*b. Results*

Participants' risk preferences can be measured as the proportion of stocks they chose (risky investment) over bonds (less risky investment). Regressing the number of risky choices on participants' age, the treatment effect, and their interaction yields the following results: we find a negative main effect for age ( $\beta = -.008$ ,  $t[296] = 2.03$ ,  $p = .043$ ), that is, people become more risk averse with age; a marginally significant main effect for depletion ( $\beta = -.163$ ,  $t[296] = 1.81$ ,  $p = .07$ ), and a marginally significant interaction ( $\beta = .004$ ,  $t[296] = 1.65$ ,  $p = .1$ ). While participants' age was predictive of increasingly less risky preference in the control condition, the opposite was true when cognitive resources were scarce because of the prior unrelated depleting task (Figure 1).

**Figure 1**

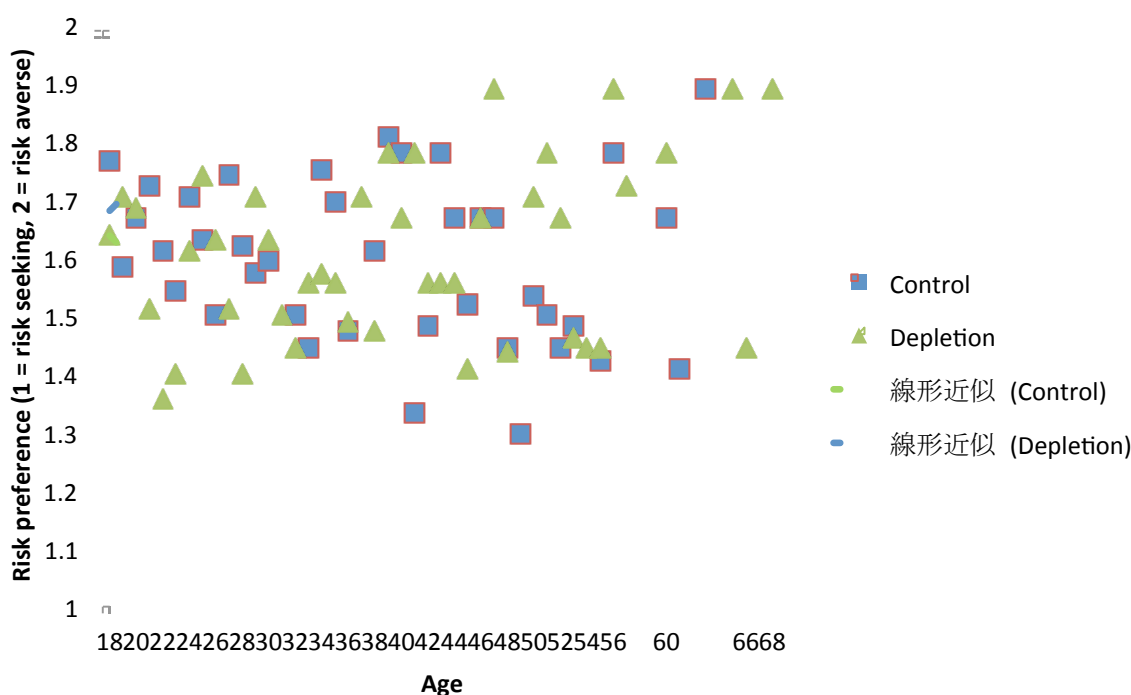

With respect to insurance choice, we find that while younger participants seem to be somewhat more inclined to choose the cheaper plan (i.e., the more risky alternative) than their older counterparts (Figure 2), this effect is further exaggerated when the subject is depleted of cognitive resources ( $t[162] = 2.33$ ,  $p = .02$ ). That is, when cognitively depleted of, the younger audience will be much more likely to opt for the more risky insurance plan.

**Figure 2**

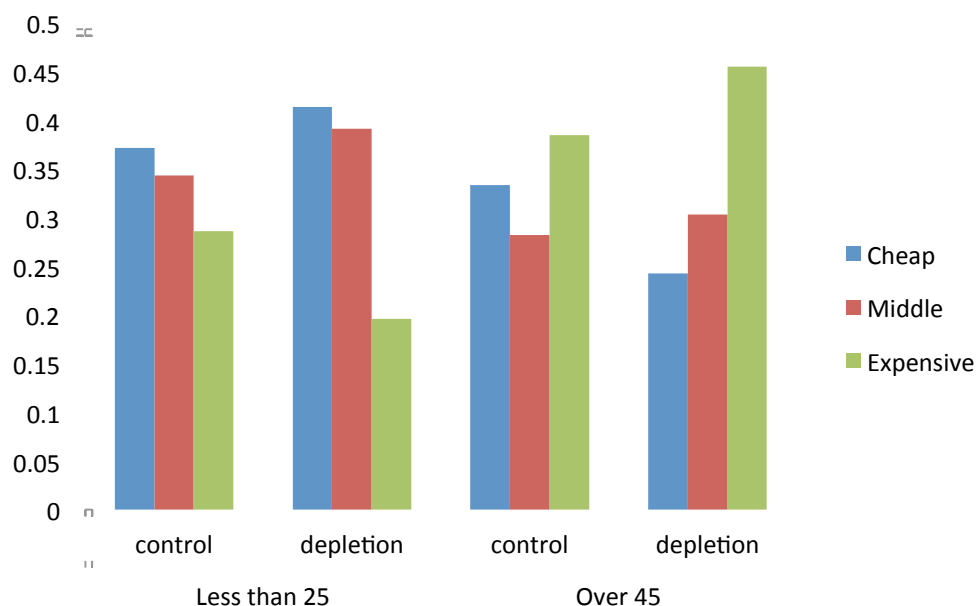

*b. Discussion*

Our experiment again leads to insights of three types: effects of aging, effects of cognitive depletion, and the potential interactions of these two effects. Consistent across both financial investments and the choice of insurance, we find that as people age they tend to take less risk and make safer choices. However, we also find that when depleted of cognitive resources, the opposite is true for financial decisions--it is the older participants who tend to take greater risk in their preferences for stocks over bonds. Conversely, with respect to health insurance plans, cognitive depletion yielded an increase in risk-taking for the younger participants, exacerbating their already inflated risk profile relative to their older counterparts.

**IV. General Discussion and Policy Implications**

The study aimed to shed light on preferences for risk and retirement savings as a function of both age and the processes underlying the preference dynamics. Above and beyond rational reasons for varying preferences across different ages, such as differences in the life length of an investment, predicted career cycles or the proximity to retirement, there may be psychological differences among age groups. In order to disentangle these different effects, we designed a set of studies that presented various retirement-related decisions involving to people of various age groups. In order to shed light on the underlying psychological mechanisms, we manipulated the degree of available cognitive resources to realistically mimic different decision conditions and states.

Overall, when cognitive resources are available, our findings show that older participants opt for more prudent savings choices. Although older people on average seem to choose the more rational options among available alternatives, in the sense of

planning and saving, this pattern may not hold in situations that do not allow the luxury of executive control override, such as when tired, sick, distracted, or even after making a series of arduous other choices. In some instances, we also find the depletion of cognitive resources has an increased influence over older participants compared to younger participant. It is possible that older people are more susceptible the effects of depletion.

There are also situations in which age itself impacts the degree of temptation inherent in the decision. A good example is our lump sum versus annuity choice upon retirement choice. Here, the lump sum becomes more attractive as one gets closer to retirement. Indeed, we find that younger participants were less impacted by the temptation of receiving all savings at once. This incidence can presumably be explained by the temporal distance between the subject and the receipt of funds, as evidenced by the effect of depletion on this decision: when younger participants were depleted their choice pattern resembled that of their older counter-parts. Conversely, when available cognitive resources were higher, the younger participants chose the annuity option *more* often than the older participants. This underscores that age by itself is not a clear-cut proxy for risk preferences. Rather, age interacts with both the context of choice and the circumstances of the decision-making process.

At a theoretical level our findings suggest that much of the difference in financial choices between older and younger decision-makers lies in the ability of the decision-makers to override their intuitive and automatic responses (System 1) to such decisions. In other words, making more prudent financial choices appears to be a learned skill that relies on executive resources (System 2) for its execution.

In the two sets of experiments, we observed age differences in judgment and decision-making pertaining to future savings and risk. The findings that younger people are more likely to exemplify risk-taking behaviors while older people are more risk averse supports other studies in the field although the study of the interactions between age and risk tolerance has proven a challenge in the social sciences<sup>1</sup> (Halek and Eisenhauer, 2001). The literature indicates that older investors tend to have different attitudes toward risk than younger age groups, and yet, many of the findings have been non-conclusive and even contradictory. At the turn of the century, it was widely believed to be true among financial planners that the older a person was the more risk averse (and less risk tolerant) they became. (Grable and Lytton, 1999; Gilliam et. al, 2010; Palsson, 1996; Bakshi and Chen, 1994). However, other studies have concluded that, after accounting for other variables, age either has little to no bearing on a person's risk tolerance (Hanna et. al, 2001), or that older generations may be even somewhat more risk tolerant than younger ones. (Wang and Hanna, 1997; Hanna et al, 2001). Our findings can help explain why previous research has mixed results when it comes to the effect of age on a person's financial risk tolerance.

The literature in general accepts a "life-cycle risk aversion" hypothesis that entails the idea that risk aversion increases with age because as people get older their number of future pay checks decreases and so does their ability to make up for potential losses,

---

<sup>1</sup> The variation of risk tolerance along demographic lines has proven difficult in the social sciences. Interestingly, for example, the literature on the effect gender is also divided. It has been found in numerous studies that women have a lower risk tolerance than men, while other studies question these characteristics. See e.g., Fairlie, and Holleran 2011.



while those who are younger have plenty of time to make up for potential losses before they retire. Our findings show that more than the passage of time is at work with risk preferences and the findings offer a more nuanced picture of how age interacts with different decision-making processes.

In general, the literature consistently indicates that people in all age groups have difficulty in accurately assessing their own risk tolerance and preferences (Feldman and Lobel, 2010; Grable et. al, 2009; Moreschi,2005). Therefore, given this inability to self-assess and the conflicting and inconclusive findings in the existing literature, context-specific experimental manipulations offer insight into the cognitive processes underlying these choices. This method has the advantage of isolating certain variations and investigating the issues with a specific focus on particular areas of risk. Our studies support the understanding that risk tolerance is not an absolute personality feature, but varies within subjects according to various factors (Stewart and Brown, 2006).

From a policy perspective, the laws should direct the adoption of defaults in retirement saving plans that most reflect the population's underlying preferences and goals of well-being. As regulators shift to setting defaults among private choices, providing information, incentives and education rather than requiring one standard plan, policymakers must pay more attention to their role in shaping the decision-making environments and processes that affect individual choice. Depletion manipulations mirror many real life situations where multi-tasking or attention-control is required. For example, filling out long retirement plan option forms or the presence of flashing banners on a computer screen that display financial information can be distracting and lead to the depletion of an individual's ability to focus and synthesize information later on. Individuals do not arrive at the decision-making table as a tabula rasa chooser, but instead arrive with varying levels of cognitive resources at any given time. Beyond the significance of understanding the mechanisms of decision-making and judgement by manipulating levels of depletion in an experimental study, policy also shapes the decision-making environment to allow for greater focus and a more consistent choice process.

Policy plays an especially important (and legitimate) role in guiding behaviour in the context of retirement, as studies have shown that when choosing retirement plan features, participants who have weak preferences often adopt the features of median participants rather than their own initial selections (Benartzi and Thaler, 2002). Importantly, behavioral tendencies of starting to invest at an early age and setting up automatic deposits significantly impact the level at which individuals will save in the next stages of the life cycle (Hira et. al, 2009). Similarly, research indicates that gaining experience in investment planning in other financial contexts increases the likelihood to enrol and manage personal retirement accounts (Hira et. al, 2009). The spill over and accumulative effects of learning make it all the more important for policy to encourage prudent future financial planning patterns from an early age. To wit, while the effects in the experiments appear relatively small, from a policy perspective even small percentages of increased savings accumulate to very significant improvements in social planning.

Our experiments point to several specific ways in which policymakers can encourage higher enrollment and savings in retirement plans. First, our findings indicate the

wisdom of SMT-style plans. Benartzi and Thaler (2004) envisioned the SMT as having four features. First, employees are approached about increasing contribution rates three months prior to a scheduled salary increase. Second, if they choose to join, their contribution increases upon the first paycheck of the salary raise. Third, contributions automatically increase at every salary raise until a maximum is reached. Fourth, the plan is set as an opt-out at any time system. Beyond bounded rationality, recent studies in the behavioral field point to “bounded self-control”. People hold correct views with regard to their lives, but they lack the discipline or willpower to execute the correct choice (Mullainathan and Thaler, 2001; Baumeister, 2002). Our findings support the intuition that SMT structure is specifically helpful in overcoming self-control issues, by allowing individuals to self-commit in advance and reducing the effects of discounting of future losses. Individuals feel less the loss of future contributions than their immediate allocations. Also, tying the increase of retirement plan payments with salary increases helps people with their mental accounting: the absolute sums of their paychecks will remain commensurate with the increase in their contributions.

Another context worth emphasizing is the interaction between decisions to enroll in savings plans and the level of savings. Since behavior is often influenced by default choices, such as automatic enrollment defaults, it may be the case that while more people participate in a pension plans, levels of savings may remain conservative. This happens when contribution rates offered as a default are lower than what those chosen by individuals who would have chosen to enroll anyway. (Choi et. al, 2001). Therefore, any policy that sets default savings must be sensitive to not only the increased numbers of enrollment, but also to the overall impact on absolute savings. Our findings show that cognitive resources not only affect on/off decisions regarding the act of enrollment, but additionally affect the level of savings and contributions.

Third, the question of annuities must receive larger attention in pension reform debates. The risk of outliving one's assets in retirement is increasingly high. While the question of increasing savings and pension enrollment has become widely recognized for its significant impact on retirement planning in the future, there has been less attention to questions of how savings and pensions will sustain their holders in later age. Often, policies measure their success by the increase in the number of participants in a certain plan, without much concern about whether the saved assets will be adequate to reach their goal of sustaining the well-being of the client throughout their retirement. In our study, we examine this side of decision-making as well. A way to ensure that retirement savings continue to sustain individuals as they age is through lifelong annuities (Mitchell and McCarthy, 2003). Recent studies find that retirees holding annuities are more satisfied with their retirement (Panis, 2003). And yet, in most countries only relatively small percentage of retirement savings is currently devoted to annuities (Moore and Muller, 2002). In fact, while in the past the default for defined benefit plans was usually a life annuity, the recent majority of defined benefit plans offer lump sum distribution. Indeed, under American law, defined benefit plans must offer an annuity option - a series of monthly payments guaranteed for life – while defined contribution plans are not, by law, required to offer participants the option of taking an annuity (Purcell, 2007). A recent study shows that a majority of company pension distributions occur in lump sum cash outs and not in lifetime annuity payments (McGill et. al, 2004). In 2010, the U.S. Departments of Labor (DOL) and Treasury issued a request for comments on whether the agencies

should issue regulations to promote the use of annuities for participants in employer-sponsored defined contribution (DC) plans and individual retirement accounts, as part of the agencies' effort to enhance retirement security by reducing the risk that workers will run out of funds during their retirement years. According to the recent report, the number of active participants in DB plans fell from about 27 million in 1975 to approximately 20 million in 2006, according to the DOL. By contrast, the number of active participants in DC plans increased from about 11 million in 1975 to 66 million in 2006 (Federal Register 2010). Other countries, with Switzerland being a notable example on this end of the spectrum, have far greater rates of annuities, often due to mandatory requirements to annuitize (Bütler & Teppa 2007). At the same time, policy must consider the possibility that high levels of annuities can have a moral hazard effect of reluctance to work at an older age (Bütler 2009).

These large country variances again can be at least partly explained by behavioral effects. Individuals tend to underestimate the risk of outliving their savings, and prefer immediate control and return of investment. Brown et al. (2008) posit that individuals over-evaluate lump sums because they use a narrow "investment frame" that focuses on risk and return rather than a "consumption frame" that considers the consequences for lifelong consumption. Moreover, recent studies investigate how annuitization decisions are affected by changes in the annuity's value (Bütler, Staubli & Zito 2010). Our findings show that with the right framing, most participants in our study in fact preferred annuity payments to lump sum. This suggests that framing and changing the way information is provided to consumers can make a significant difference in shifting decisions toward annuity products. In others words, choice architecture, with specific attention to cognitive load during the decision making process, may be as effective as the harsher forced choices of annuitization.

Moreover, the interaction of age and depletion in this context indicates a reversal of the assumed aging effect on risk tolerance. Our findings showed that younger participants in a replenished state were more likely to opt for annuity payments. Policymakers and employers aiming to help individuals overcome their own default preferences biases can set annuities as the default option, rather than lump sum payment upon retirement.

Finally, from an information and decision-making environment perspective, our findings underscore the need for a tailored approach to successfully address each of these issues. For example, policymakers may also take into account that different age groups rely on different authorities to inform their decision-making. There is some indication in the literature that later in life individuals rely more on published information for advice than on family and friend networks. Similarly, where aging and experience leads to better choices, policymakers can draw upon the changing risk preferences that are brought upon by aging and adopt in particular contexts by instituting "modified default options" requiring individuals to take action to review their risk decision-making every several years (Poterba, 2005). This type of regulation would force individuals to face the decisions that they may otherwise seek to avoid, as they grow older and move from one risk group to another. Most generally, our findings suggest that there may be great value in education programs, informational programs, and decision-making settings that are specifically tailored by age groups.

## V. Toward an Eye to the Future

Correcting cognitive bias through regulation presents unique challenges and choices (Amir and Lobel, 2008; Amir and Lobel, 2012; Korobkin and Ulen, 2000). Yet, the insights offered in the fields of behavioural economics and experimental psychology in recent years suggest the need for policy to engage in such inquiries in order to better aid the goals and challenges of wellbeing, retirement, and aging. As decision-making becomes more individualized, we strive to understand how decision-making happens in particular contexts and with regard to particular demographics (Yablon, 2004; Eskridge and Ferejohn, 2002). In general, our studies suggest that people's risk preferences are not absolute but are to some degree relative to the range of available options, contexts, and the state of the decision-maker.

In light of the problems created by individual assessment of risk and estimation of future problems, and the current trends stressing nudges, consumer, patient and investor education, policies that aid individual decision-making are an important facet of governance. While some scholars have argued that education needs to be emphasized much more, others claim that education would actually have few positive effects because it would not address the cognitive biases that influence investment decisions. Our study shows that moving beyond education, choice architecture designed based on insights provided by behavioral studies can become a focal point for policymakers. As such, we can begin to view laws as providing the context and direction for individuals striving to direct their own lives (Huang, 2008). Moreover, any attempt to impact individual behaviour through policy naturally requires a discussion about its legitimacy from a democratic and governance perspective (Amir and Lobel, 2012; Klick and Mitchell, 2006). In the context of retirement planning and pensions, the malleability of risk preferences gives more legitimacy to the role of the policymaker to positively impact people's choices in ways that contribute to their long-term well-being. Changes in the makeup of the economy and the population have created new challenges for future retirees. Regulations that are more in sync with how individuals of different ages process risk can be shaped to adapt to the new landscape and provide an improved background to private decision-making.

## REFERENCES

- Amir, O. and Lobel, O.(2012). "Liberalism and Lifestyle: Informing Regulatory Governance with Behavioral Research", *European Journal of Risk Regulation*, 3(1), pp. 2098-2138.
- Amir, O. and Lobel, O. (2008). "Stumble, Predict, Nudge: How Behavioral Economics Informs Law and Policy", *Columbia Law Review*, December, pp. 2098-2138.
- Amir, Pocheptsova, Dhar, & Baumeister (2009) Deciding Without Resources: Psychological Depletion and Choice in Context, *JOURNAL OF MARKETING RESEARCH*.
- Amir et al. (2005) Psychology, Behavioral Economics, and Public Policy, *MARKETING LETTERS*, 16, 443.
- Amir, O. and Ariely D. (2007). "Decisions by Rules: The Case of Unwillingness to Pay for Beneficial Delays", *Journal of Marketing Research*, February, pp. 142-152.
- Amir, O and Ariely, D. (2008). "Resting on Laurels: The Effects of Discrete Progress Markers as SubGoals on Task Performance and Preferences", *Journal of Experimental Psychology: Learning, Memory, & Cognition*, 34 (5), pp. 1158-1171.
- Amir, O. and Levav, J. (2008). "Preference construction versus choice construction: The instability of preferences learned in context", *Journal of Marketing Research*, April, pp. 145-158.
- Baumeister (2002) Yielding to Temptation: Self-Control Failure, Impulsive Purchasing, and Consumer Behavior, *JOURNAL OF CONSUMER RESEARCH* 28(4), 670-76.
- Burgess, A. (2012). "Nudging Healthy Lifestyles – Informing Regulatory Governance with Behavioural Research", *European Journal of Risk Regulation*, 3(1), pp.
- Bicksler, J.L. and Chen, A.H. (30 Apr 2012). "The Integration of Insurance and Taxes in Corporate Pension Strategy" article published online
- Bakshi, G. S., and Chen, Z. (1994). "Baby Boom, Population Aging, and Capital Markets," *Journal of Business*, 67, 165-202.
- Benartzi, S. and Thaler, R.H.(2002). "How Much Is Investor Autonomy Worth?" *Journal of Finance* (57)4, pp. 1593-1616.
- Benartzi, S. and Thaler R.H. (2004). "Save More Tomorrow: Using Behavioral Economics to Increase Employee Saving." *Journal of Political Economy*, 112(1), pp. 164-187.
- Brown J.R. & Jeffrey R. Kling & Sendhil Mullainathan & Marian V. Wrobel, 2008. "Why Don't People Insure Late-Life Consumption? A Framing Explanation of



**the Under-Annuity Puzzle**,"American Economic Review, American Economic Association, vol. 98(2), pages 304-09, May.

Browning, E.S. (Feb 19, 2011). "Retiring Boomers Find 401(k) Plans Fall Short", *Wall Street Journal*.

Bütler, M. (2009). Switzerland: High Replacement Rates and Generous Subsistence as a Barrier to Work in Old Age. The Geneva Papers on Risk and Insurance - Issues and Practice(34), 561-577.

Bütler, M. & Staubli (2010) The Role of the Annuity's Value on the Decision (Not) to Annuity: Evidence from a Large Policy Change, Discussion Paper, 2010-05.

Butler, Monika & Teppa, Federica (2007) **The choice between an annuity and a lump sum: Results from Swiss pension funds**, Journal of Public Economics, Elsevier, vol. 91(10), pages 1944-1966, November.

Chao, E. U.S. Newswire, U.S. Secretary of Labor Elaine L. Chao Announces Proposed Rule on Default Investment Alternatives for Participant-Directed Plans, Sept. 26, 2006.

Chatterjee, S., and Zhu, D. (2010). "Determinants of Risk Tolerance in the Baby Boom Cohort," *Journal of Business & Economics Research*, 8(5), pp. 79-88.

Choi, J., Laibson, D., Madrian, B.C. and Metrick, A. (2002). "Defined Contribution Pensions: Plan Rules, Participant Choices, and the Path of Least Resistance", *Tax Policy and the Economy*, 17, pp. 67-114.

Davis, D.A. (2006). "Do-it-Yourself Retirement: Allowing Employees to Direct the Investment of Their Retirement Savings", *University of Pennsylvania, Journal of Labour and Employment Law*, 8, pp. 353-386.

Dulebohn, J.H. (2002). "An Investigation of the Determinants of Investment Risk Behaviour in Employer-Sponsored Retirement Plans", *Journal of Cost Management*, 28, pp. 3-26.

Eskridge, W. and Ferejohn, J. (2002). "Structuring Law-making to Reduce Cognitive Bias: A Critical View", *Cornell Law Review*, 87, pp. 616-647.

Faff, R., Mulino, D., and Chai, D. (2008). "On the Linkage Between Financial Risk Tolerance and Risk Aversion," *The Journal of Financial Research*, 31(1), pp. 1-23.

Fairlie, R. W., & Holleran, W., 2011. Entrepreneurship Training, Risk Aversion and other Personality Traits: Evidence from a random Experiment. *Journal of Economic Psychology*, doi: 10.1016/j.joep.2011.02.001

*Federal Register* Vol. 75, No. 21 2010 <http://www.dol.gov/federalregister/HtmlDisplay.aspx?>

Feldman, Y. and Lobel, O. (2010). "The Incentives Matrix: A Study of the Comparative Effectiveness of Monetary Rewards as Compliance Systems", *Texas Law Review*, 88, pp. 1151-1212.

Frolik, L.A. (2010). "Protecting Our Aging Retirees: Converting 401(k) Accounts into Federally Guaranteed Lifetime Annuities", *San Diego Law Review*, 47, pp. 277-330.

Gilliam, J., Chatterjee, S., and Zhu, D. (2010). "Determinants of Risk Tolerance in the Baby Boom Cohort," *Journal of Business & Economics Research*, 8(5), pp. 79-88.

Gilliam, J., Goetz, J., and Hampton, V. (2008). "Spousal Differences in Financial Risk Tolerance," *Financial Counseling and Planning*, 19(1), pp. 3-11.

Grable, J. E., and Lytton, R.H. (1999). "Assessing Financial Risk Tolerance: Do Demographic, Socioeconomic, and Attitudinal Factors Work?", *Family Relations and Human Development/Family Economics and Resource Management Biennial*, 3, pp. 80-88.

Grable, J. E., McGill S., and Britt S. (2009). "Risk Tolerance Estimation Bias: The Age Effect," *Journal of Business and Economics Research*, 7(7), pp. 1-12.

Goldstein, D.G., Johnson, E.J. and Sharpe, W.F. (2008). "Choosing Outcomes versus Choosing Products: Consumer-Focused Retirement Investment Advice", *Journal of Consumer Research*, 35, pp. 440-456.

Hacker, J.S. (2011). "Restoring Retirement Security: The Market Crisis, the "Great Risk Shift," and the Challenge for our Nation", *Elder Law Journal*, 19, pp. 1-47.

Halek, M. and Eisenhauer, J. G. (2001). "Demography of Risk Aversion", *The Journal of Risk and Insurance*, 68, pp. 1-22.

Hanna, S. D., Gutter, M. S., and Fan, J. X. (2001). "A measure of risk tolerance based on economic theory," *Financial Counseling and Planning*, 15(2), pp. 53-60.

Hira, T. K., Rock, W. L., and Loibl, C. (2009). "Determinants of retirement planning behaviours and differences by age", *International Journal of Consumer Studies*, 33, pp. 293-301.

Holt, C., and Laury, S. (2002). "Risk Aversion and Incentive Effects," *American Economic Review*, 92(5), pp. 1644-1655.

Huang, P.H. (2008). "Diverse Conceptions of Emotions in Risk Regulation", *University of Pennsylvania Law Review Pennumbra*, 156, pp. 435-447.

Kahan, D.M. (2008). "Two Conceptions of Emotion in Risk Regulation", *University of Pennsylvania Law Review*, 156, pp. 741-766.

Kim, H. and Kim, J. (2010). "Information Search for Retirement Plans Among Financially Distressed Consumers", *Journal of Family and Economic Issues*, 31(1), pp. 51-62.

Kim, B., Zauberman, K.G. and Bettman, J.R. (2012). "Space, Time, and Intertemporal Preferences", *Journal of Consumer Research* (forthcoming).

Klick, J. and Mitchell, G. (2006). "Government Regulation of Irrationality: Moral and Cognitive Hazards", *Minnesota Law Review*, 90, pp. 1620 -1663.

Korobkin, R.B. and Ulen, T.S. (2000). "Law and Behavioral Science: Removing the Rationality Assumption from Law and Economics", *California Law Review*, 88, pp. 1051-1144.

Lawrence, J.K. (2003). "Pension Reform in the Aftermath of Enron: Congress' Failure to Deliver the Promise of Secure Retirement to 401(k) Plan Participants", *Kentucky Law Journal*, 92, pp. 42-44.

Lobel, O. (2006). The Four Pillars of Work Law, *Michigan Law Review*, 104, pp. 1539.

Lobel (2004) The Renew Deal: The Fall of Regulation and the Rise of Governance in Contemporary Legal Thought, *MINNESOTA LAW REVIEW*, 89, 342.

Madrian, B. C. and Shea, D.F.(2001). "The Power of Suggestion: Inertia in 401(k) Participation and Savings Behavior." *Quarterly Journal of Economics*. 116(4), pp. 1149-1187.

McGill, D., Brown, K., Haley, J. and Schieber, S.(2004). *Fundamentals of Private Pensions*, ed. 8. Oxford: Oxford University Press.

Moore, J. H. and Muller., L.A(2002). "An Analysis of Lump-sum Pension Distribution Recipients." *Monthly Labor Review*, May, pp. 29-46.

Moreschi, R.W. (2005). "An Analysis of the Ability of Individuals To Predict Their Own Risk Tolerance," *Journal of Business and Economics Research*, 3(2), pp. 39-48.

O'Neill, B. (2007). "Overcoming Inertia: Do Automated Saving and Investing Strategies Work?" *Journal of Family and Economic Issues*, 28, pp. 321-335.

Palsson, A. M. (1996). "Does the degree of risk aversion vary with household characteristics," *Journal of Economic Psychology*, 17, pp. 771-787.

Panis, C. (2003). "Annuities and Retirement Satisfaction." Working Paper. RAND Corporation.

Pension Protection Act of 2006, 120 Stat. 1033 sec. 902, codified at 29 U.S.C. §§ 1001 et seq.

Poterba, J.M. (2005). "Individual Decision Making and Risk in Defined Contribution Plans", *Elder Law Journal*, 13, pp. 285-308.

Purcell, P. (2007) "Lump-Sum Distributions Under the Pension Protection Act", CRS Report for Congress <http://aging.senate.gov/crs/pension9.pdf>.

Rothman, B.P. (2002). "401(k) Plans in the Wake of the Enron Debacle", *Florida Law Review*, 54, pp. 939-40.

Sendhil, M. and Thaler, R.H.(2001). "Behavioral Economics", in *International Encyclopedia of Social Sciences*, Pergamon Press, pp. 1094-1100.

Stabile, S.J. (2007). "Business Law Forum: The Aging of the Baby Boomers and America's Changing Retirement System: Forum Article; Is It Time to Admit the Failure of an Employer-Based Pension System?" *Lewis & Clark Law Review*, 11, pp. 305-329.

Stabile, S.J. (2002). "Freedom to Choose Unwisely: Congress' Misguided Decision to Leave 401(k) Plan Participants to Their Own Devices", *Cornell Journal of Law and Public Policy*, 11, pp. 361-402.

Stewart, N., N. Chater and G. D. A. Brown. "Decision by Sampling." *Cognitive Psychology*, 53, pp. 1-26.

Venhorst, M. (2006). Note, "Helping Individual Investors Do What They Know Is Right: The Save More for Retirement Act of 2005", *Connecticut Insurance Law Journal*, 13, pp. 113-145.

Wang, H. & Hanna, S. (1997). Does risk tolerance decrease with age? *Financial Counseling and Planning*, 8(2), 27-31.

Yablon, C. (2004). "The Meaning of Probability Judgments: An Essay on The Use and Misuse of Behavioral Economics", *University of Illinois Law Review*, 2004, pp. 899-966.

*Appendix I*

Preference Assessment Method - Lottery Choice Series (Holt and Laury 2002)

<b>1/10 of \$2.00, 9/10 of \$1.60</b>	<b>or</b>	<b>1/10 of \$3.85, 9/10 of \$.10</b>
<b>2/10 of \$2.00, 8/10 of \$1.60</b>	<b>or</b>	<b>2/10 of \$3.85, 8/10 of \$.10</b>
<b>3/10 of \$2.00, 7/10 of \$1.60</b>	<b>or</b>	<b>3/10 of \$3.85, 7/10 of \$.10</b>
<b>4/10 of \$2.00, 6/10 of \$1.60</b>	<b>or</b>	<b>4/10 of \$3.85, 6/10 of \$.10</b>
<b>5/10 of \$2.00, 5/10 of \$1.60</b>	<b>or</b>	<b>5/10 of \$3.85, 5/10 of \$.10</b>
<b>6/10 of \$2.00, 4/10 of \$1.60</b>	<b>or</b>	<b>6/10 of \$3.85, 4/10 of \$.10</b>
<b>7/10 of \$2.00, 3/10 of \$1.60</b>	<b>or</b>	<b>7/10 of \$3.85, 3/10 of \$.10</b>
<b>8/10 of \$2.00, 2/10 of \$1.60</b>	<b>or</b>	<b>8/10 of \$3.85, 2/10 of \$.10</b>
<b>9/10 of \$2.00, 1/10 of \$1.60</b>	<b>or</b>	<b>9/10 of \$3.85, 1/10 of \$.10</b>
<b>10/10 of \$2.00, 0/10 of \$1.60</b>	<b>or</b>	<b>10/10 of \$3.85, 0/10 of \$.10</b>

The logo for the International Association for Frontiers in Psychology (iafor) is centered on the page. It consists of the lowercase letters "iafor" in a light blue, sans-serif font. The logo is partially enclosed by two large, overlapping, brush-stroke-like arcs: a light blue arc on the right and a light red/pink arc on the left.



*Meta-analysis of Intelligence Scores of 'Street Children' in Developing Countries*

Graham Pluck\*<sup>1</sup>, Daniel Banda-Cruz\*<sup>2</sup>

\*<sup>1</sup>Chuo University, Japan, \*<sup>2</sup>Universidad San Francisco de Quito, Ecuador

0122

The Asian Conference on Psychology & the Behavioral Sciences 2013

Official Conference Proceedings 2013



iafor

iafor  
The International Academic Forum  
[www.iafor.org](http://www.iafor.org)

In many developing countries, unsupervised children spend much of their time in the urban environment and in the context of extreme poverty. These 'street children' are generally not attending school, psychological traumas are common and rates of substance abuse are high. The multiple deprivations suffered and the exposure to factors mitigating normal neurocognitive development would suggest that attainment of optimal intellectual function would be hindered. This would have implications for interventions aimed at bringing these children back into mainstream society, which generally favour reintegration into educational programs. Despite this, there is scant published material on intelligence testing of samples of street children. A systematic review and meta-analysis of the existing academic literature was conducted in English and Spanish. Only five studies of street children that included data on intelligence tests or proxy measures of intellectual functioning could be identified. These reports, from Colombia, Bolivia, Indonesia, Ethiopia and South Africa, described 201 different children. Mean scores from the street children were compared with control sample means or population norm estimates, in the latter case adjustments were made for cross-cultural comparisons and for the Flynn effect. The adjusted means were used to calculate effect sizes (Cohen's  $d$ ). In all five samples, performance was below that which would be expected from the normal population, though there was much variation. The sample from Indonesia showed the smallest effect size ( $d=.25$ ) and the sample from Ethiopia showed the largest effect size ( $d=2.87$ ). The mean weighted effect size was 0.99. Although limited by the dearth of research on the topic, the current results suggest that the multiple deprivations suffered by street children in developing countries tend to impair normal neurocognitive development, but that the extent of this varies by culture.

The concept of 'street child' refers to those young people who spend much of their time unsupervised in the urban environment in a context of extreme poverty. A formal definition has been developed by UNICEF: *"any girl or boy who has not reached adulthood, for whom the street (in the broadest sense of the word, including unoccupied dwellings, wasteland, etc.) has become her or his habitual abode and/or sources of livelihood, and who is inadequately protected, supervised or directed by responsible adults"* (Black 1993).

In addition to UNICEF, various other charities and NGOs worldwide exist to help the street children of developing countries. These frequently publish estimates of the size of the problem, generally quoting figures of 100 million or 150 million children globally. However, the true extent of children living in the urban centres of developing countries is largely unknown. No reliable systematic surveys are available and the estimates of tens or hundreds of millions are essentially guesses (Thomas de Benitez 2011).

The reasons that children are spending much of the time in the urban environment are complex. Some may be homeless, but others, perhaps the majority, will have families to whom they return at night. Some will be begging or engaged in criminal activity and many will be child labourers, e.g. earning money by entertaining motorists or selling small items in cafes and bars. Poverty and an imperative to obtain money is a critical feature of their presence in the cities of developing countries. Street children are often demonised by the more privileged classes, by the media and security forces. In Brazil, street children are commonplace in the large cities and receive very little protection from the police. Furthermore, they may be victim to violence or assassination from local vigilante groups and even rouge police units (Inciardi & Surratt, 1998). Exposure to violence and trauma is thought to be a very common feature of the lives of street children worldwide (Thomas de Benitez 2007).

There is further health related research with street children that has often focused on substance abuse, particularly 'glue sniffing'. Indeed this form of substance abuse appears to be a common feature globally of homeless and street connected youths (e.g. Vega & Gutierrez 1998). Other research topics have been food access and undernourishment (e.g. Patriasih et al. 2010) and blood levels of lead and other toxins caused by urban pollution (e.g. Samaniego & Benítez-Leite 2002). Furthermore, there is a reasonable body of academic studies of street children stemming from sociological and anthropological work (e.g. Aptekar 1991). Academics working with and investigating the NGO sector have focused on rehabilitation efforts to move children from reliance on street living and to reengage them with educational services (e.g. Lusk 1989). Despite all these efforts, cognitive function and development of street children has been a generally neglected topic. This is something of an omission because many of the features described above (e.g. trauma, substance abuse, pollution or malnutrition) have the potential to impair cognitive functions and prevent normal neurocognitive development. In turn, this could hinder attempts at reintegrating children back into educational systems.

In contrast, there is considerably more known about the effects of homelessness on cognitive function in developed industrialised countries. Reports from the USA (e.g. Solliday-McRoy et al. 2004) and England (e.g. Pluck et al. 2012) have demonstrated that, based on population norms, IQ scores are lower than would be expected in samples of homeless adults. Indeed, such homeless samples appear to score about one standard deviation below the population norms provided by the test manufacturers. The evidence suggests that this reduction in cognitive ability is acquired and is associated with many of those features known to be overrepresented in homeless populations in developed countries. For example, high rates of childhood traumatic

experiences, psychiatric illness and alcohol and drug abuse are associated with cognitive impairment in homeless adults (Pluck et al. 2011).

Similarly, in developed countries, reductions in expected IQ scores are observed in samples of homeless children and children in homeless families. For example, a study of black homeless families in the USA reported that as a group, the children scored at the 34th percentile on an IQ test (Masten et al. 1997), equating to an IQ of about 86. On the test used the population mean was set at 100 with a standard deviation of 15. So it can be seen that the children scored in the same pattern as homeless adults, about one standard deviation below the population mean.

We have recently performed a systematic review of cognitive functions of street children in developing countries and reported that a wide range of cognitive and neuropsychological impairments have been described, albeit from a small corpus of research involving only seven studies reporting on 215 individuals (Pluck 2013). Furthermore, the studies used a wide range of methods, limiting cross-cultural comparisons. Nevertheless, there was a pattern of cognitive developmental problems and in some samples neuropsychological impairments and evidence of acquired brain damage. Only four studies included data on general intellectual function (e.g. IQ). Comparison of these scores seemed to suggest significant global variation. Nevertheless, the conclusion was that there is a relatively consistent pattern of poor performance on tests of intellectual function by samples of street children.

Since that systematic review was performed, a fifth publication has become available. This describes a neuropsychological study of street children in La Paz and El Alto, Bolivia (Dahlman et al. 2012). This includes data on a measure of IQ and also includes data on a comparison group of poor but not homeless children. In order to help interpret this new data, we have extracted the important information so that it can be compared with the data reported in the previously described systematic review. In addition, it is possible to calculate effect sizes for the five different studies, so that despite the different data collection methods used in each, direct comparisons of the results can be made. Furthermore, the subsequent effect sizes from the five different studies can be used to produce a weighted average to describe the overall estimated effect size. In essence, to provide a single statistic that conveys the results from all the available data.

However, to do this there are some methodological issues that must be considered. It is known that globally there has been a steady increase in IQ test performance. Indeed the 'Flynn effect', as it is known, describes how IQ scores have increased by about 3

points each decade (Neisser 1997). In effect, IQ tests will tend to overestimate as they become older. Therefore, comparisons of effect sizes of IQ scores, such as attempted in this meta-analysis, must account for the Flynn effect.

In addition, there is also significant global variation in IQ test score performance. Population means are different in different countries. However, as we wished to focus on developing countries, this presents a problem. In many such countries standardised and normed IQ assessments have not been available and researchers have frequently resorted to using tests from the large developed countries (generally the USA). However, what is normal in the USA is not necessarily normal in other countries. Although controversial, estimations for average IQ scores for most countries have been published (Lynn & Vanhanen 2002). These can be used to correct for geographical variation, when for example a USA normed test has been used outside the USA. Although these IQ estimates are controversial and imprecise, to correct with them will probably increase the accuracy of estimates of gaps between observed IQ score performance and what would be expected in the normal (local) population.

To summarize, we report on a systematic review and meta-analysis of scores of intellectual function of street children in developing countries.

## Methods

The systematic literature review that recovered the studies from Colombia, South Africa, Ethiopia and Indonesia has been reported previously (Pluck 2013). The search was performed in July 2012. The search was performed in both English and Spanish using the large global search engines for academic material (e.g. Web of Knowledge, Google Scholar). The definition used for 'street children' was: "*Street children are recognised to be young people who experience a combination of multiple deprivations and 'street-connectedness'*" (Thomas de Benitez 2011 p viii). Studies were included if the children fulfilled this definition and were aged between 5 and 16. The search revealed 7 studies reporting on 215 individual street children. However, data on intellectual function (e.g. IQ) was only reported in four different samples. These were on samples of street children in Indonesia (Hartini et al. 2001), South Africa (Jansen et al. 1990, 1992), Ethiopia (Minaye 2003) and Colombia (Aptekar 1988).

In December 2012, the search was repeated and this located a fifth article that had recently been published. It reported on a sample of 36 homeless street children (all boys) from Bolivia and provides comparison data on 31 domiciled but



socioeconomically similar boys (Dahlman 2012). A summary of all the available studies with data amenable for meta-analysis is provided in Table 1.

**Table 1:** Studies included in the meta-analysis of intellectual function test scores of street children

City and Country	Sample	Mean age	Comparison group	Test of intellectual function	Reference
Cali, Colombia	56 street children	11.6 (range = 7-16)	Normative data	Kohs Block Design	Aptekar, 1988
El Alto and La Paz, Bolivia	36 boys with experience of living in the street	14.1 (SD = 1.8)	31 domiciled boys of similar SES	Leiter Performance Scale	Dahlman et al (2012)
Ngagel and Banyu Urip, Indonesia	42 street children	11.5 (range = 10-12)	Normative data	Cattell Culture Fair Test-ii	Hartini et al, 2001
Johannesburg, South Africa	44 street children (half were glue sniffers)	14.1 (SD = 1.46)	22 domiciled children	Category Test of the Halstead-Reitan Battery	Jansen et al, 1990, 1992
Addis Ababa, Ethiopia	23 child beggars	5.6	30 children from a local kindergarten	Custom made tests	Minaye, 2003

The IQ and other measures of intellectual function were corrected for the Flynn effect and for regional differences in the use of norms as necessary. In effect this involved adding 0.3 IQ points to the normative mean for each year that had passed between the publication of the research and the publication of the IQ test. Where normative IQ scores had been used from the USA and formed comparisons of data from other countries, the population norm for the local country was adjusted by reference to the expected difference in IQ scores between that country and the USA based on the tables provided by Lynn and Vanhanen (2002).

## Results

For the data from Bolivia, South Africa and Ethiopia, comparison data was provided on control groups. Therefore the calculation of interest was the score difference between the street children sample and the control sample. For the other reports,

control data was not provided, and its place normative population estimates have been used, in each case adjusted for the Flynn effect and geographical variation. In each case, effect sizes were calculated with Cohen's  $d$  (Cohen 1992). A summary of the study-by-study effect sizes are shown in Figure 1. Although such effect sizes are not usually represented with polarity, we have maintained the plus/minus information in order to represent the direction of the difference between the street children sample and the respective comparison data. A negative value indicates that the street children performed worse than the comparison group. In addition we have used the qualitative categories also provided by Cohen (1992) to describe effect sizes, these are 'negligible' from 0 to .2, 'small' from .2 to .5, 'medium' from .5 to .8 and 'large' if larger than .8.

In Figure 1 we can see that in all cases the effect sizes were negative, indicating that the street children samples achieved lower scores than their respective comparison samples. However, there is considerable variation by study location, the Indonesian report had only a small effect size ( $d=-.25$ ) while the Ethiopian report had a large effect size ( $d=-2.87$ ). When the data describing all 201 cases reported in the five studies is combined, the estimated weighted effect size is  $d=-.099$ .

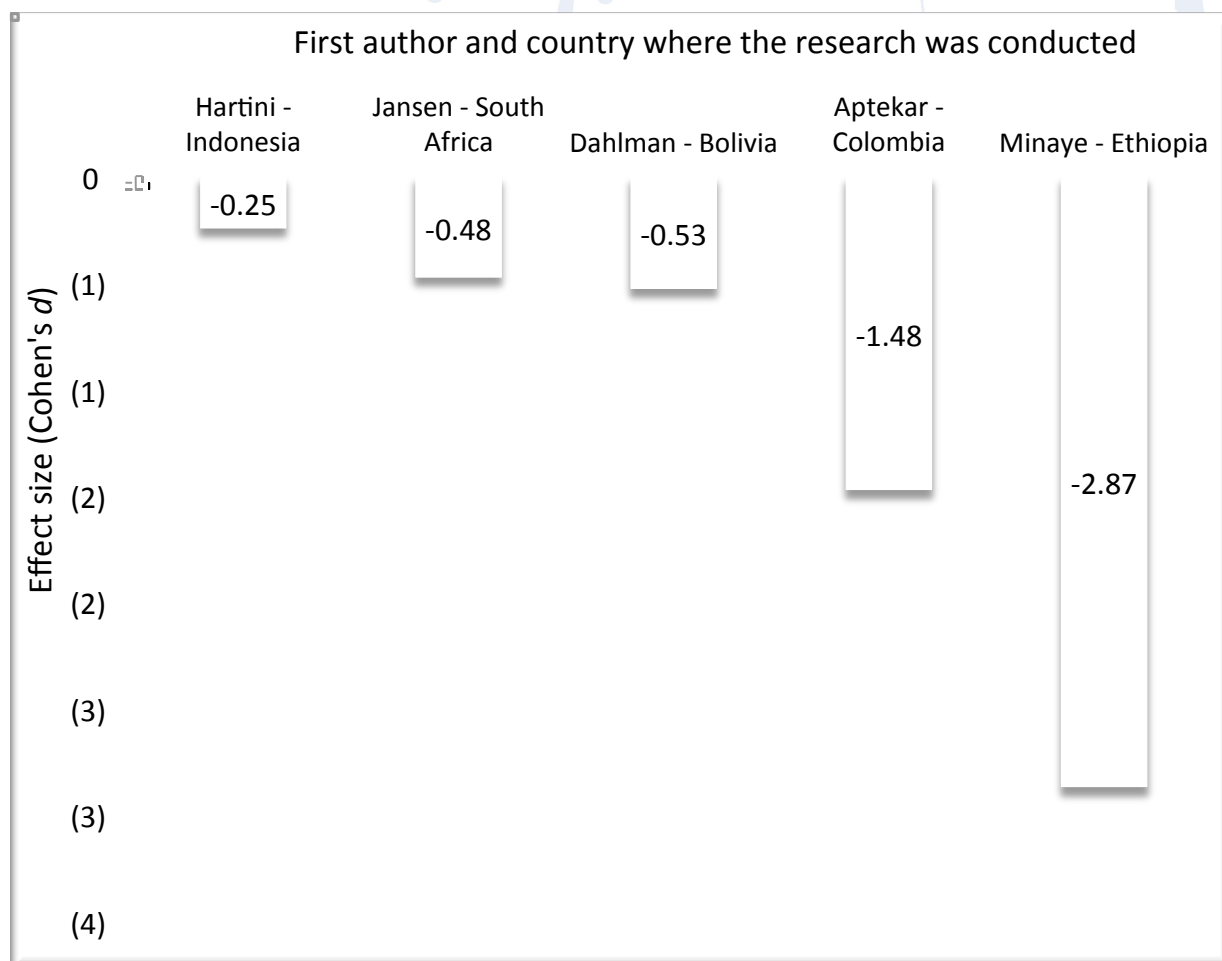

**Figure 1:** Effect sizes for tests of intellectual function scores by the street child samples from the five countries when compared with a control or normative sample

## Discussion

We have reported on a systematic review of cognitive function of street children in developing countries and performed a meta-analysis on all of the available data relevant to general intellectual function. Only five studies reported in six publications and involving only 201 individual children were identified. Poorer performance by the street children samples compared to the comparison data was observed in all five of these studies; however, there was considerable variation. For example the effect size reported in the Indonesian study was only  $d=-.25$ , by convention this would be considered a small effect size, as would the effect size in the South African sample ( $d=-.48$ ). The effect size in the Bolivian study would be considered of medium size ( $d=-.053$ ) and the others, both the Colombian ( $d=-1.48$ ) and Ethiopian ( $d=-2.87$ ) would be considered large effect sizes.

When the data from all five studies was combined, the estimated average weighted effect size was  $d=-0.99$ . This indicates that, on average, the street children performed almost exactly one standard deviation below what might be expected of children in their culture (in the analysis we used, the effect size is equivalent to the number of standard deviations of difference). However, it must be noted that as this is a meta-analysis, it is dependent on the volume of previous reports. As described, only five studies were available, reporting on only 201 children. Although we noted in the introduction that the extent of the problem of children spending much of their time unsupervised in urban environments is unknown, it is clear that 201 children studied is a tiny figure in relation to magnitude of the issue globally.

In addition, this analysis is dependent on the quality of the existing reports. These were generally quite small studies, and some used barely adequate methods to measure intellectual functioning. For example the study in Ethiopia used custom made tests of knowledge and vocabulary (Minaye 2003). This is partly understandable, as normed and validated tests are often not available in developing countries. Nevertheless, the use of non-standard assessments or inappropriate assessments weakens the interpretation of this meta-analysis.

Despite this, some conclusions can be reached. There was an obvious pattern to the study-by-study effect results. In each case the effect sizes indicated that the street children studied performed worse than their comparison groups. There was significant

geographical variation, this should perhaps not be surprising, as the local contexts in which the children live in each culture will vary tremendously. The average effect size was very close to one.

A mean effect size that approximates one is of interest as the same phenomenon has been observed in homeless populations in developed countries. For example Pluck et al. (2012) have shown that homeless adults in the UK scored below population means by effect sizes of 1.0 for IQ and 0.99 for memory performance. Similar effects of homeless adults scoring one effect size below the population mean have been demonstrated in the USA (e.g. Solliday-McRoy et al. 2004). Furthermore, the same phenomenon has been observed in homeless children in the USA (Masten et al. 1997). It would appear therefore, that there is a general phenomenon of distributions of intellectual function test scores displaying a pattern in which those of particularly low socioeconomic status in a society score on average one standard deviation below the estimated average for the population as a whole.

This analysis cannot directly inform on the reasons for the one standard deviation effect. To some extent this may reflect a natural tendency in capitalist and meritocratic societies in which high IQ allows people to protect themselves from poverty, leaving those less able to occupy the lower socioeconomic strata. However, there are also other factors which can be identified which likely drive poor cognitive development of street children.

Substance abuse is an important issue. It has been reported to exist at very high levels among many groups of street children. Glue sniffing in particular seems to be linked to the socioeconomic deprivation and urban living of street children (e.g. Dominguez et al. 2000; Gutierrez & Vega 2003). This is perhaps due to its low cost and accessibility. Unfortunately, glue sniffing is a particularly toxic and harmful practice that can cause permanent brain damage. Indeed, one of the studies included in this analysis, from South Africa, also reported that of those street children who were glue sniffers, most had neurological signs suggestive of brain damage (Jansen et al. 1990).

Another cause of differences in cognitive function between street children and more privileged children in the general population is access to formal education. As most street children are not attending school, it could be argued that this will delay their learning and general cognitive development. Although, in many developing countries, school attendance is not necessarily the norm for most children anyway. Furthermore, in many cultures where there are street children, the children are in fact child labourers, working in the urban environment, for example selling flowers or candies

to motorists. It could be argued that their real world experience compensates for their lack of formal education in driving their cognitive development. In fact, there is some evidence for this. In Brazil, some of the street children who work as vendors have mathematical abilities comparable to those of regularly schooled children. Furthermore, for some forms of calculation, the street children are significantly better than school attending children (Saxe 1988).

In conclusion, the results of this meta-analysis suggest that there is a large degree of cultural variation in the cognitive development of street children in developing countries. However overall, the results suggest that street children tend to score about one standard deviation below what would be expected of children in general in their culture. It is unclear to what extent this reflects a natural phenomenon of capitalist societies, acquired neurocognitive impairment or delayed cognitive development. Regardless of this, the magnitude of the effect on intellectual functioning suggests that it will likely hinder attempts at bringing street children into mainstream education.

## References

- Aptekar, L. (1988). Street children of Colombia. *The Journal of Early Adolescence*, vol. 8, pp 225-241.
- Aptekar, L. (1991) Are Colombian street children neglected? The contributions of ethnographic and ethnohistorical approaches to the study of children. *Anthropology and Education Quarterly*, vol. 22, pp 326-349.
- Black, M. (1993) *Street and Working Children*: Seminar Report. Florence: UNICEF.
- Cohen, J. (1992) A power primer. *Psychological Bulletin*, vol. 112, pp. 155-159.
- Dahlman S, Bäckström P, Bohlin G & Frans O. (2012) Cognitive abilities of street children: Low-SES Bolivian boys with and without experience of living in the street. *Child Neuropsychology*, Advance Online Publication.
- Dominguez, M., Romero, M. & Paul, G. (2000) Los “Niños Callejeros” una visión de sí mismos vinculada al uso de las droga, *Salud Mental*, vol. 23, pp. 20-28.
- Gutierrez, R., & Vega, L. (2003) Las investigaciones psicosociales sobre la subsistencia infantil en las calles desarrolladas en el INP durante los últimos 25 años, *Salud Mental*, vol. 25, pp. 27-34.
- Hartini, N., Subekti, E. M. A., & Nur Ainy, F. (2001) The IQ and EQ profile of street children. *Jurnal Penelitian Dinamika Sosial*, vol. 2, pp. 32-40.



Inciardi, J.A. & Surratt, H.L. (1998) Children in the streets of Brazil: drug use, crime, violence, and HIV risks, *Substance Use and Misuse*, vol. 33, pp. 1461-1480.

Jansen, P., Richter, L.M. & Griesel, R.D. (1992) Glue sniffing: a comparison study of sniffers and non-sniffers, *Journal of Adolescence*, vol. 15, pp. 29-37.

Jansen, P., Richter, L.M., Griesel, R.D. & Joubert, J. (1990) Glue sniffing: A description of social, psychological and neuropsychological factors in a group of South African 'street children', *Suid-Afrikaanse Tydskrif vir Sielkunde*, vol. 20, pp. 150-158.

Lusk, M.W. (1989) Street children programmes in Latin America, *Journal of Sociology and Social Welfare*, vol. 16, pp. 55-77.

Lynn, R., & Vanhanen, T. (2002) *IQ and the Wealth of Nations*. London: Praeger.

Minaye, A. (2003) *A special form of child abuse: using children for begging and its psychological effects on the behavior of children*. Unpublished M.A. thesis, Addis Ababa University, Addis Ababa, Ethiopia.

Masten, A.S., Sesma, A., Si-Asar, R., Lawrence, C., Miliotis, D. & Dionne, J.A. (1997). Educational risks for children experiencing homelessness, *Journal of School Psychology*, vol. 35, pp. 27-46.

Neisser, U. (1997) Rising scores on intelligence tests. *American Scientist*, vol 85, pp. 440-447.

Patriasih, R., Widiaty, I., Dewi, M. & Sukandar, D. (2010) Nutrient intake and nutritional status of street children in Bandung, *Journal of Nutrition and Food*, vol. 5, pp. 178-184.

Pluck, G. (2013) Cognitive abilities of 'street children': a systematic review, *Chuo Journal of Policy Sciences and Cultural Studies*, vol. 21, pp. 121-133

Pluck, G., Lee, K.H., David, R., Macleod, D.C., Spence, S.A. & Parks, R.W. (2011) Neurobehavioural and cognitive function is linked to childhood trauma in homeless adults, *British Journal of Clinical Psychology*, vol. 50, pp. 33-45.

Pluck, G., Lee, K.H., David, R., Spence, S.A. & Parks, R.W. (2012) Neuropsychological and cognitive performance of homeless adults, *Canadian Journal of Behavioural Science*, vol. 44, pp. 9-15.

Samaniego, E. & Benítez-Leite, S. (2002) Niveles de plomo en sangre en niños de áreas urbana y sub-urbana, *Pediatría*, vol. 29, pp. 10-16.

Saxe, G.B. (1988) The mathematics of street child vendors, *Child Development*, vol. 59, pp. 1415-1425.

Solliday-McRoy, C., Campbell, T.C., Melchert, T.P., Young, T.J. & Cisler, R.A. (2004) Neuropsychological functioning of homeless men, *Journal of Nervous and Mental Disease*, vol. 192, pp. 471-478.

Thomas de Benitez, S. (2007) *State of the World's Street Children: Violence*. London, UK: Consortium for Street Children.

Thomas de Benitez, S (2011) *State of the World's Street Children: Research*. London, UK: Consortium for Street Children.

Vega, L., & Gutierrez, R. (1998) La inhalación deliberada de hidrocarburos aromáticos durante el embarazo de adolescentes consideradas como de la calle, *Salud Mental*, vol. 21, pp. 1-9.

The logo for 'iafor' is centered on the page. It consists of the lowercase letters 'iafor' in a light blue, sans-serif font. The text is enclosed within a circular graphic composed of two overlapping, thick, brush-stroke-like lines. The outer line is light blue and the inner line is light red, creating a sense of depth and movement around the text.

iafor

*Multiple Creativities: A Task to Set up a New Model to Creative Thinking*

Hossam-Eddin AbulHassan Hassan

Jazan University, Saudi Arabia

0127

The Asian Conference on Psychology & the Behavioral Sciences 2013

Official Conference Proceedings 2013

Abstract

This study seeks to provide a new understanding of what it is called *Multiple Dimensional Creativities* by setting up new model explaining the dynamic process of creativity. This study aims to focus on new arena of psychology by raising the question whether we have one and only one form of creativity or creativity can be represented through different forms. In other words, are we talking about one sort of creativity or multiple interconnected sorts of creativity? This study will give a new account of what we call multiple dimensional creativities abbreviated as MDC.

Keyword : " Multiple Creativities" , " Fluentlies" , " Flexibilities" , "Originalities" , " Multiple Dimensional Creativities MDC".

## Introduction:

It is claimed by Gardner(1993) that intelligence is not one form as it is approved by others, but it can be argued it is multiple intelligences. In other sense, it is not fair to characterize a person that he is an intelligent or not, or his intelligence has certain scale or degree. This theory is not fair in terms of the fact that it does not explain why an individual is a unique in particular field or he got a talent in particular arena and in the same time, he is not unique in other fields. Another aspect of Gardner's theory is that it put an end to the former concept of measuring intellectual ability by reducing it to the IQ test. In addition, it set up a profile for intellectual abilities of individual as an objection to the classical theories which paid attention and concern to the linguistic and mathematical logical abilities ignoring the others.

*Multiple Intelligences Theory was originally developed as an explanation of how the mind works—not as an education policy, let alone an education panacea. Moreover, when we and other colleagues began to consider the implications of the theory for education, the last thing we wanted to do was multiply educators' jobs ninefold. Rather, we sought to demonstrate that because students bring to the classroom diverse intellectual profiles, one “IQ” measure is insufficient to evaluate, label, and plan education programs for all students.*( Moran.et al., 2006).

Due to this lack of explanation, another call raised by Gardner to find out an answer to that problem. It is argued that intelligence is a structure and that structure is consisted of eight different multiple intelligences. This theory leads us to raise the question about the relationship between multiple intelligences and creativity whether we have one form of creativity or accordingly we have multiple forms of creativities. For instance both Eliot and Einstein focused on what is called linguistic intelligence for the former and mathematical-logical intelligence for the latter.

This account of creativity matches with Gardner's theory of intelligence where intelligence is as a structure consisting of independent abilities separated from each other's referring to certain form of intelligence. For example, having progress in linguistic fluently does not necessarily mean having progress in rational abilities such as numerical or spatial abilities. In other words, all people, in respect to their Varsity, have creative abilities that vary among individuals.

Therefore it can be indicated here in that context that creative thinking is a **dynamic cognitive process** leading to new product described as flexible and original. In other terms, the outcome of this process is not haphazard or chaotic but an outcome of intellectual creative activities as it can be traced by scientists, philosophers and artists. Shi (2004, 176) indicated that most of theories deal with creativity focus on social behavior of human being and his surroundings. This account claims that creative behavior of an individual takes place due to his cultural background and accordingly his society will be assessed in the light of individuals' creative activities and behaviors. Accordingly, it can be said that emergence of MIT and its application to learning domain led to new approaches supporting the differences between learners where individual works and communicates in such way that enables him to achieve his self actualization and satisfies his desires. In respect to that understanding, we are trying here to develop a new account based on our understanding of MIT and trying to bridge between MIT from one side and creativity from another side. This bridging will lead to set up a model of what we call *multiple dimensional creativities* model or MDCM as we will explain now. We will try here to create a new profile which

emerges from MDC where it shed light to the importance of profile in the field of education which goes up with Gradner's concept of profile.

*The greatest potential of a multiple intelligences approach to education grows from the concept of a profile of intelligences. each learner's intelligence profile consists of a combination of relative strengths and weaknesses among the different intelligences: linguistic, logical-mathematical, musical, spatial, bodily-kinesthetic, naturalistic, interpersonal, intrapersonal, and (at least provisionally) existential (Gardner, 2006).*

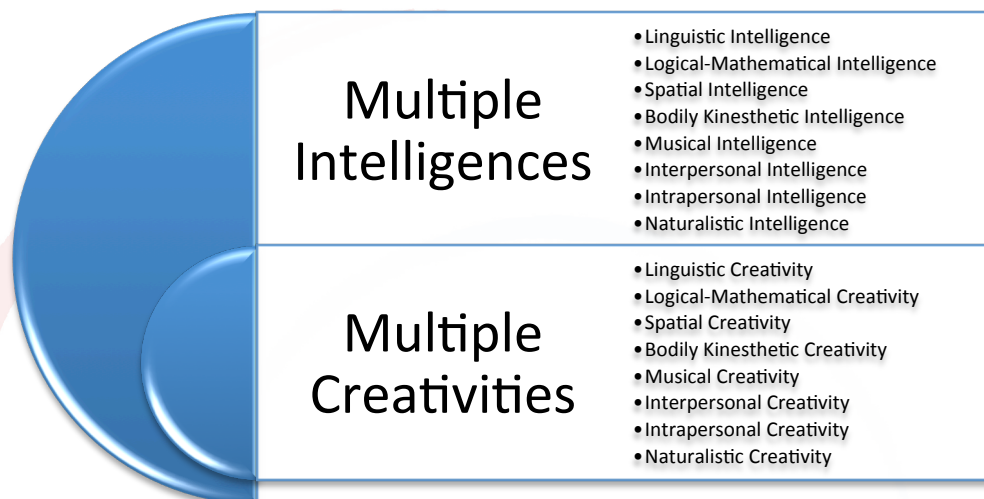

(Figure 1) indicates the bridge between MIT and MDC

### Intelligence and Multiple Dimensional Creativities:

In this section we will try to discuss the idea whether is possible to talk about one form of creativity or we are indeed talking about multiple forms of creativity. I argue here that it is appropriate not to talk about one form of creativity but about different forms or aspects of creativity. In this context, we are trying to take the structure of MIT to further field of creativity. The importance of MIT is based on the fact it shows that there is no an univocal dimension of intelligence but we have multiple aspects of intelligence. The same thing can be applied also to the field of creativity. This application leads us to eight different forms of creativity as well. These forms of creativity can be classified to the followings:

- 1- Linguistic Creativity.
- 2- Logical-Mathematical Creativity.
- 3- Visual Spatial Creativity.
- 4- Bodily Kinesthetic Creativity.
- 5- Musical Creativity.
- 6- Interpersonal Creativity.
- 7- Intrapersonal Creativity.
- 8- Naturalistic Creativity.



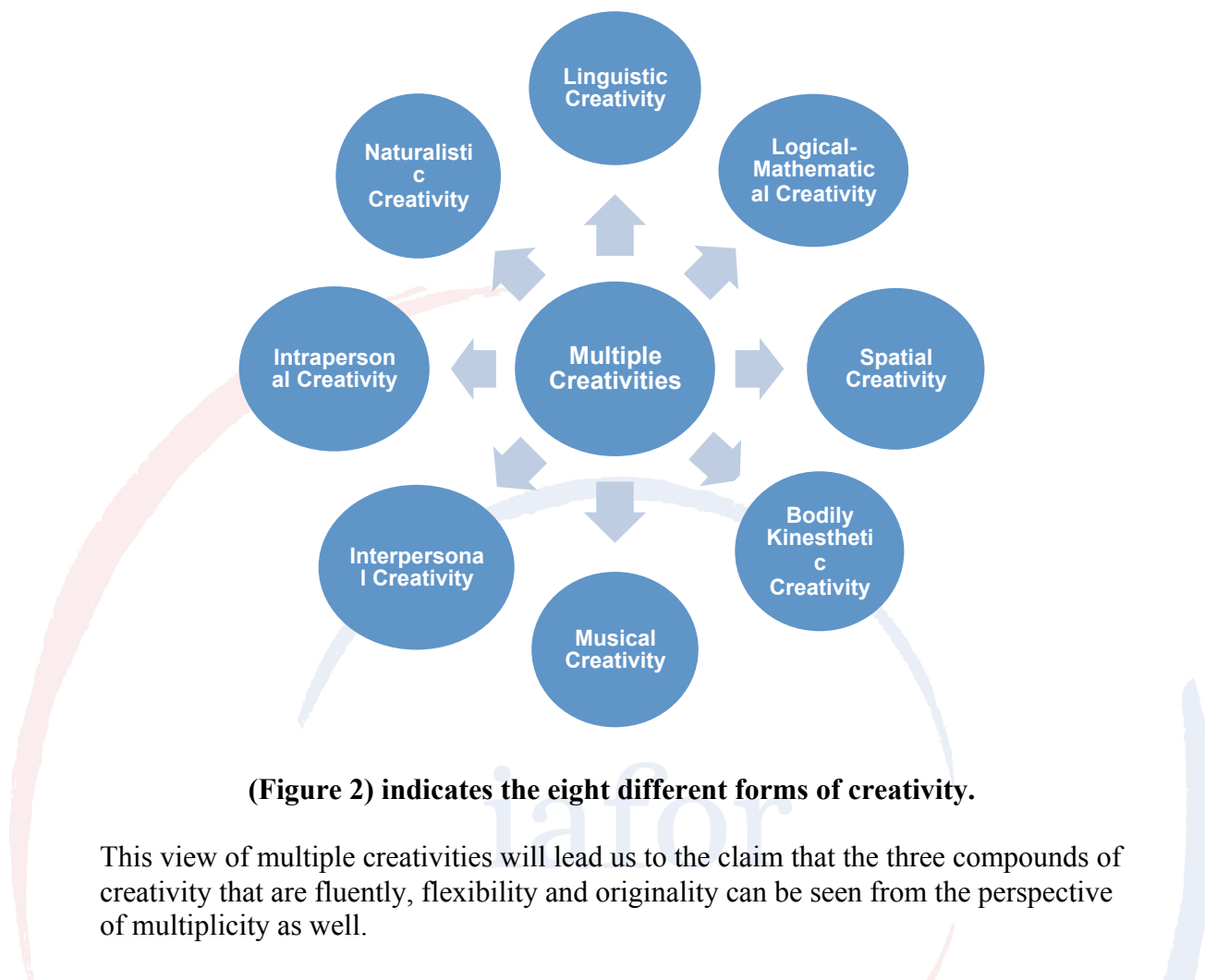

**(Figure 2) indicates the eight different forms of creativity.**

This view of multiple creativity will lead us to the claim that the three compounds of creativity that are fluently, flexibility and originality can be seen from the perspective of multiplicity as well.

### **2-1 Multiple Dimensional Creativities and Fluentlies:**

It has been claimed earlier that the three features of creativity can possibly be seen from the same point of multiplicity. Here it will be shown that fluently is no longer considered one fluently but we are talking here about multiple aspects of fluently. Fluently is defined as the ability to produce much numbers of ideas and responses in certain time. It is argued that there are eight forms of fluently matching with the eight forms of creativity as the following:

Linguistic Fluently: defined as the ability to create a great deal of words or terms submitted under certain condition such as beginning or ending with exact letter.

Logical Mathematical Fluently: defined as the ability to create a great deal of logical mathematical responses submitted under certain conditions.

Spatial Fluently: defined as the ability to create a great deal of visual spatial responses submitted under certain conditions from one side and depended on both visual and spatial dimensions and 3D space.

Musical Fluently: defined as the ability to create a great deal of musical responses such as composing tunes and producing harmonic sounds. In addition creating numbers of melodies, ringtones and rhythms submitted under certain conditions.

Motional or Kinetic Fluently: defined as the ability to use someone body to create a great deal of motional responses. mathematical responses submitted under certain conditions.

Intrapersonal Fluently: defined as the ability to create a great deal of responses where an individual shows his own abilities and self faculties.

Interpersonal Fluently: defined as the ability to create a great deal of interpersonal responses in different social situations.

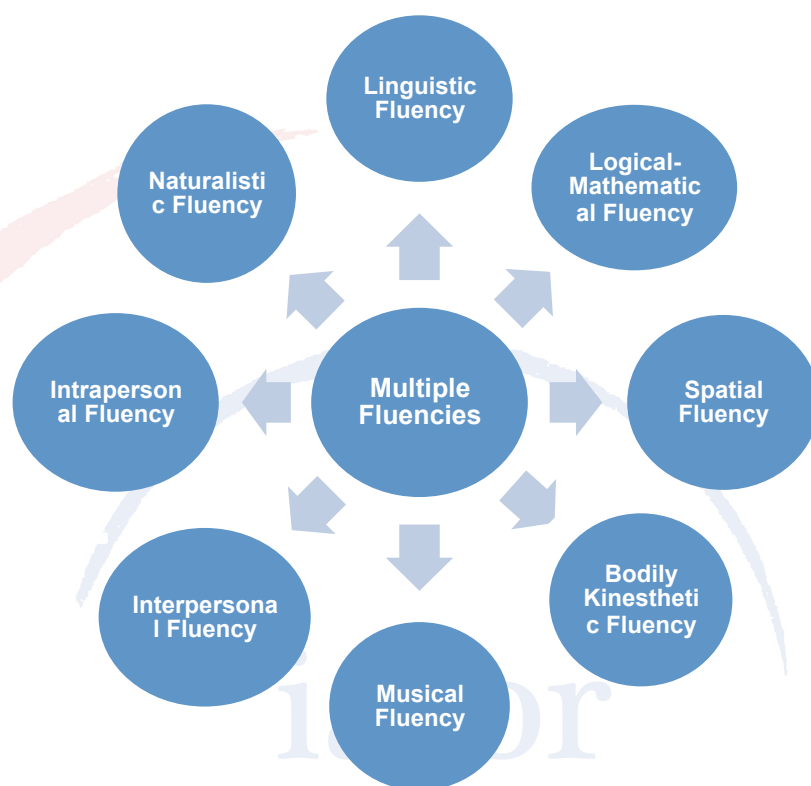

(Figure 3) indicates the multiple aspects of Fluently

## 2-2 Multiple Dimensional Creativities and Flexibilities:

Here in this section we will show that flexibility is no longer considered one form of flexibility but we are talking here about multiple aspects of flexibility.

Flexibility is defined as the variety of ideas produced by an individual, or the speed of creating ideas belonging to different domains of life.

Linguistic Flexibility: defined as the speed of producing items and words belonging to different domains of life meeting certain conditions.

Logical and Mathematical Flexibility: defined as the speed of producing solution either mathematical or logical to various situations solutions meeting certain conditions.

Spatial Flexibility: defined as the speed of finding out spatial solutions in various situations meeting certain conditions.

Musical Flexibility: defined as the speed of responses to various melodies and tunes from one side and producing rhythm meeting certain conditions.

Motional Flexibility: defined as the speed of producing bodily motions meeting certain conditions.

Intrapersonal Flexibility: defined as the speed of producing intrapersonal responses meeting certain conditions.

Interpersonal Flexibility: defined as the speed of producing solutions to different social and interpersonal situations meeting certain conditions.

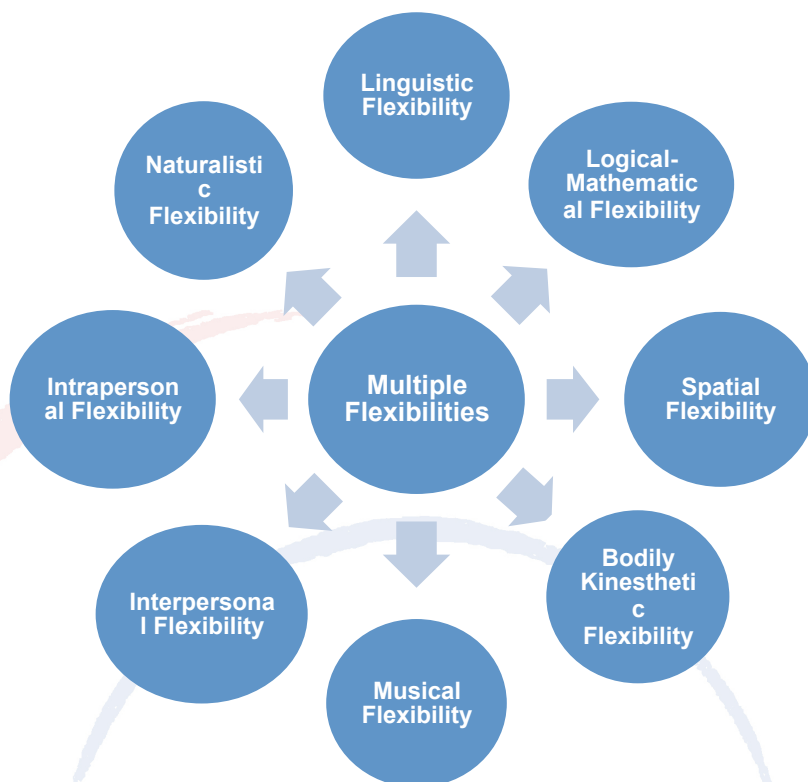

**(Figure4) indicates the multiple aspects of Flexibility**

### **2-3 Multiple Dimensional Creativities and Originalities:**

Here in this section we will show that originality is no longer considered one form of originality but we are talking here about multiple aspects of originality.

Originality is defined as the ability to create original ideas that are neither frequent nor common among group of individuals.

Linguistic Originality: defined as the ability to produce original items and verbal expressions are not common among the group, an individual belongs to it.

Logical and Mathematical Originality: defined as the ability to produce original logical and mathematical ideas that are neither frequent nor common among the group ,an individual belongs to it.

Spatial Originality: defined as the ability to produce original spatial responses that are not common among the group, an individual belongs to it.

Musical Originality: defined as the ability to produce original melodies and rhythms that are not common among the group, an individual belongs to it.

Motional Originality: defined as the ability to produce original motional responses that neither common nor frequent among the group, an individual belongs to it.

Intrapersonal Originality: defined as the ability to produce original intrapersonal and subjective responses that are not common among the group, an individual belongs to it.

Interpersonal Originality: defined as the ability to produce original social and interpersonal responses that are not common among the group, an individual belongs to it.

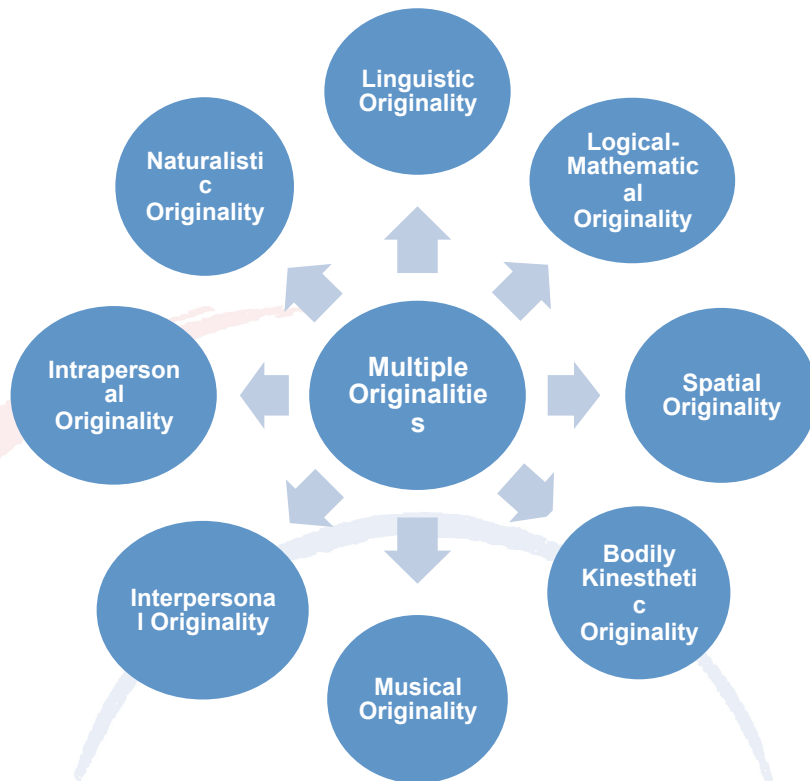

**(Figure 5) indicates the multiple aspects of Originality**

### **1-3 Inter-relationship and Multiple Creativities:**

In this section we will answer the question how MCTM works out and what are the main characteristics of that model

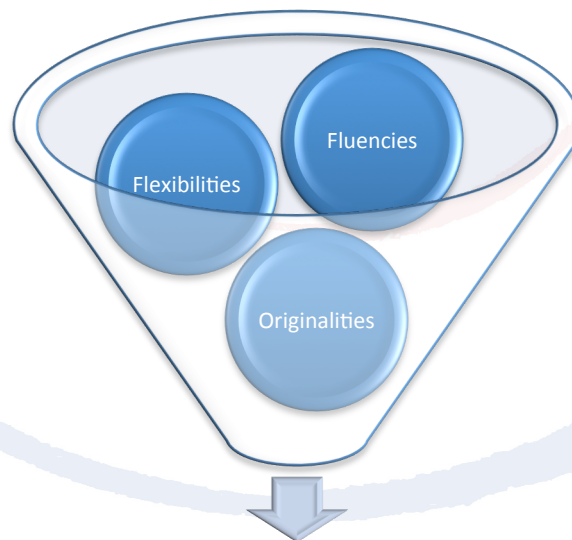

**Creativities**

**(Figure 6-A)**

**Flexibilities**

**Fluencies**

**Creativities**

**Flexibilities**

**(Figure 6-B)**  
**(Figure 6-A&6-B) indicate the inter-relationship between the elements of  
creativities**

#### **Basic Features of MDC:**

From what has been discussed so far, one can claim that the individuals' creativities can be seen through a profile that distinguishes between stronger creativities and weaker or feeble creativities. There are differences in creativities can be found among people, and these differences are quantitative not qualitative. On the other hand, these creativities are not detached from each other but they are interacted to produce certain outputs. This case of harmonic and systematic interaction leading to new and unique creative output is similarly to the harmonic tune brought by different musical instruments. This understanding leads us to derive three basic features distinguishing our MDC. These features are the followings:

##### **1- Interference**

It is not necessarily that all forms of creativities work systematically, however they can work contradictory. For instance, an individual can show high level in mathematical creativity, but he may encounter a certain difficulty if he has lack of linguistic and intrapersonal skills.

##### **2- Compensation**

It can be found sometimes that one form of creativities compensate another form of creativity. For instance, an individual may have not high level of musical creativity, but he may have high level of kinesthetic creativity which can be effectively used to compensate the shortage or lack of musical creativity that he or she suffers.

##### **3- Enhancement:**

It has been comprehended here in this context as when a particular form of creativities got enhanced or reinforced by another form of creativity, for example, spatial creativity may enhance an individual's to compose new ideas about mathematical concepts and problems. In other sense, certain form of creativity can be motivated by another form of creativity.

This model suggests that before providing an answer to the question why a particular student encounters such difficulty. It has been shown in this context that the strength



of an individual cannot be measured in respect of creativities degrees based on multiple creativities list meaning that if one form of creativities is feeble and weak then the total sum will necessarily be weak.

### **Conclusion:**

It has been claimed here that to develop a holistic picture about an individual's abilities, we no longer talk about one form of creativity, flexibility and originality. MCD multiple creativity model suggests that a holistic profile where we no longer have one form of creativity, but multiple forms of creativities, flexibilities and originalities. Our concern was to show how dynamically MCD works and how systematically it is activated. It has been suggested that three basic features distinguishes MDC that are interference, compensation and enhancement. Finally this model is recommended to be applied to school where it clearly offers a holistic profile of mental abilities of the students who encounter certain difficulties in their studies instead of giving concern to one ability only. This reflects the importance of a profile which we tried to discuss through this paper.

### **References:**

- 1) Gardner, H. (1993). *Frames of Mind : Theory of Multiple Intelligences*. 10th ed, Basic Books, New York.
- 2) Gardner, H. (2006). *Multiple intelligences: New horizons*. New York: BasicBooks.
- 3) Moran, S.; Kornhaber, M. & Gardner, H. (2006). Orchestrating Multiple Intelligences, *Educational Leadership*. September, 22-27.
- 4) Shi, J. (2004). Intelligence Current in Creative Activities. *High Ability Studies*, 15(2), 173-187.

*Taiwanese Parents' Reactions to the Achievement of their Children: Vertical  
Distinctiveness Versus Horizontal Distinctiveness*

Kuei-Hsiang Han

Tamkang University

0128

The Asian Conference on Psychology & the Behavioral Sciences 2013

Official Conference Proceedings 2013

Abstract

Study 1 adopted parents of 1<sup>st</sup> and 2<sup>nd</sup> graders as well as 8<sup>th</sup> and 9<sup>th</sup> graders as participants to recall their children's good performance or achievements. The results showed that parents of 8<sup>th</sup> and 9<sup>th</sup> graders recalled higher ratio of vertical distinctiveness (VD) than any other type of achievement while parents of 1<sup>st</sup> and 2<sup>nd</sup> graders recalled more good performance in the field of horizontal distinctiveness (HD). The three most mentioned categories of achievements for parents of 8<sup>th</sup> and 9<sup>th</sup> graders to mention were: VD, HD, and good behavior. However, it became HD, good behavior, and then VD respectively for parents of 1<sup>st</sup> and 2<sup>nd</sup> graders. Study 2 used scenario experimental method to examine parents' reactions to the achievement of their high school children. The results found that parents would be more likely to encourage their children to pursue career in VD field, and felt more matched their expectation if their children pursue their career in VD field. On the contrary, parents would feel more regretful if their children pursue their future career in HD goals instead of VD. Interestingly, although parents experienced the same intensive feelings of having face when their children had a success in the field of VD versus HD, they did feel having more face on their daughter's success in VD goals and less having face in HD goals comparing to the same success of their son.

**Keywords:** big self, having face, horizontal distinctiveness, social orientation, vertical distinctiveness

## **Introduction**

Tafarodi, Marshall, and Katsura (2001) divided Asian's highly pursued life goals into: Vertical Distinctiveness (VD) and Horizontal Distinctiveness (HD). VD goals are those approved by the general public; therefore, one may obtain praise from the whole society when achieving these goals. On the contrary, HD goals are those pursued by the actor out of personal interest; therefore, when one achieving these goals, s/he may not obtain equal praise from the whole society (Hwang, Chen, Wang, & Fu, in press). Although parents value good performance and talents of all aspects of their children, due to the social orientation in Confucian societies (Yang, 1992) and the prevalent effects of academic elitism, it is very possible that parents may adjust their expectation to their children from appreciate both VD and HD to focus mainly on VD when their children are gradually growing up and facing the stress of getting into "top-ranked". In consideration of these two types of distinctiveness and parents' feelings of their children's achievements might differ when their children are in different developing stage (whether facing the stress of Entrance Exam of High School and University or not). The first part of this study would like to compare whether there is any difference in contents of recalled achievements or good performance between parents of 1<sup>st</sup> and 2<sup>nd</sup> graders and parents of 8<sup>th</sup> and 9<sup>th</sup> graders. The different contents of good performance could reflect that Confucian societies did value VD goals more than HD. The second part of this study would examine parents' feelings of having face and other related reactions when their children were achieved in VD versus HD goals.

## **Literature Review**

Hwang, Chen, Wang, and Fu (in press) emphasized that there are two types of achievement goals pursued by students in Confucian society. 'Vertical distinctiveness' (VD) goals are those approved by the general public. Having achieved the goal, the actor may obtain praise from the whole society. 'Horizontal distinctiveness' (HD) goals are those pursued by the actor out of personal interest. Though the peer group may share similar interests with the actor and approve of these personal goals, significant others and the general public in the society may not do so. When a child is in his/her childhood, there is no doubt that parents appreciate good performance of their child. Especially for the low birth rate in Taiwan and for the thoughts that do not let children losing in the beginning of their life, most parents are willing to spend money to develop all aspects of their children's potential talents when they are young (Huang & Huang, 2009). However, since people in Confucian societies are very social-oriented, people enjoy praise and compliments from others (Yang, 1992). Due to the characteristic of VD goals and HD goals differs in

acceptance and appreciation from others, it is apparent that Chinese people value VD goals more than HD goals.

As aforementioned, parents value all the talents and good performance of their children. However, because of the prevalent influence of academic elitism and getting into top ranked, it is very possible that parents may adjust their expectation to their children from appreciate both VD and HD to focus mainly on VD when their children are getting older and facing the stress of the Entrance Exam of High School and/or University. Parents may switch their emphasis and attention to children's performance from all aspects of talent to mainly focus on academic performance, which implies transferring attention from HD to VD. Chiu's (2005) study found that there were differences in ratio between the fifth and the sixth graders attending in the "dance-music" type of after-school classes. The ratio of fifth graders was higher than that of the sixth graders, and the results of this study implied that children had encountered more social demands on academic achievements and parents might switch their support of their children's performance from general aspects to academic performance.

On the other hand, one of the basic features of Confucian societies is the concept of 'Big Self'. Under this concept, an individual's family members, especially parents and children, are more likely to be included in the territory of one's self (Hwang, 1999; Hwang & Han, 2011). The relationship between parents and children is usually perceived as a single body in the eyes of Chinese people. As a result, family members are especially liable to the feelings of having glory or shame together. In other words, an individual's achievement or good performance is not only his/her own success, but is also counted to his/her parents' glory (Hwang, 2005; Li, 1993; Lu, 2003).

As Yu and Yang (1987) pointed out that the goals for people in Confucian societies to pursue is determined by social demands, especially from the request or expectation of one's parents. Studies have found that parents have direct, extreme effects on their children's decision of future career, especially for the gifted students (Chen, 1991; Lin, 1993). Then, it will be very possible that although parents appreciate their children's talents and performance in both fields of VD and HD, as their children are getting older, they will encourage their children to pursue socially approved goals in VD field, hoping their children to receive more social achievements. Comparable with this idea, study had found that children in Confucian societies were more willing to work hard on a task for their parents comparing to their Western counterparts (Iyengar & Lepper, 1999). Su and Hwang (2003) also found that retired people in Taiwan experienced

more intensive feelings of having face for their children's achievements in VD goals. The results of aforementioned studies imply that children in Confucian societies may change their pursuit of distinctiveness from horizontal goals to vertical goals to meet their parents' expectation. As a result, children's good performance might increase in VD field, and on the other hand, decrease in HD because they learn from their socialization and switch their attention to value VD goals more than HD.

Thinking that because Confucian societies value VD goals more than HD and parents' focus on VD or HD goals might have an effect on their children's performance. Study 1 would like to investigate whether the dimensions of children's good performance or achievements do differ when they are in different developing stage, especially whether they are facing the stress of Entrance Exam of High School or not.

### **Study 1: Parents' Recall of Children's Good Performance**

Considering that when children are in their early childhood, parents would appreciate their good performance in all aspects; therefore, from parents' perspective, they will notice both their children's VD and HD performance. Moreover, since there is little academic competition for young children, it is very possible that children can develop and perform freely in the field of HD, and thus, impress others. However, when children are gradually growing up and facing the stress of the Entrance Exam of High School, parents may encourage their children to focus mainly on academic performance by valuing their VD performance more to meet the requirements of elitism in a social oriented society. Therefore, endeavoring to perform well in VD goals becomes the central issue of children's daily life. As a result, elder children's achievements in VD goals might override their HD goals. The purpose of Study 1 is to examine whether younger children do exhibit more good performance in the field of HD than VD; whereas, elder children who are facing the stress of academic achievements will have more good performance in the field of VD than HD. However, since it is difficult to have young children to report their good performance, this study adopt parents as participants to report their children's good performance and/or achievements.

## **Method**

### **Participants**

The participants were divided into two groups: One group consisted of 121 parents of 1<sup>st</sup> and 2<sup>nd</sup> graders, among them, 21 (17.4%) were male and 100 (82.6%) were female (ages from 25 to 67,  $M = 40.11$ ,  $SD = 4.75$ ). The other group consisted of 170 parents of 8<sup>th</sup> and 9<sup>th</sup> graders, 38 (22.4%) of them were male and 132 (77.6%) were female



(ages from 32 to 67,  $M = 44.72$ ,  $SD = 4.58$ ).

### **Research design and instruments**

The purpose of study 1 is to collect young versus elder children's good performance or achievements of all aspects. However, because it would not be plausible to ask young children to report their good performance, this study adopted parents as participants and asked them to report their children's good performance and/or achievements in any aspects of talent and academy which may represent horizontal or vertical distinctiveness respectively. To maximize the effects that children's good performance would switch from HD to VD goals when they are getting older and facing more social demands on academic elitism, study 1 collected data from participants of two groups: one group of parents of 1<sup>st</sup> and 2<sup>nd</sup> graders, and the other of parents of 8<sup>th</sup> and 9<sup>th</sup> graders. The recalled achievement data of these two groups were collected and analyzed separately.

Participants in this study were instructed to recall either an episode in which they thought their child had a good performance or an episode in which their child was praised by others. Then, participants were instructed to write down this good performance or achievement in detail.

### **Procedures**

Noting that Parent-Teacher Association (PTA) meeting will be held on 'School Day' at elementary and middle schools in the beginning period of semester and it would be a good chance for us to access our potential participants. We contacted both elementary and middle schools in Taipei area to ask whether it was possible for us to collect questionnaires on their School Day. 10 schools (5 elementary schools and 5 middle schools) in large Taipei area gave us positive answer. We then visited these schools on their School Day before the PTA meeting began and asked those parents who arrived school earlier waiting for the meeting to fill out our questionnaire.

### **Results**

The data of good performance and achievements were categorized mainly according to its relatedness to VD or HD. The similar and repeatedly-mentioned events were categorized together. The results showed that mainly 5 categories of good performance and/or achievements were generated. Contents of each category and its frequency distribution were presented in Table 1-1.

Table 1-1 Contents and frequency distribution of participants' recall good performance of their child

Contents of different category	Frequency for 1 <sup>st</sup> and 2 <sup>nd</sup> Graders (N = 121)	Frequency for 8 <sup>th</sup> and 9 <sup>th</sup> Graders (N = 170)
<p><b>1. Achievements Related to VD Goals, including academic performance...</b>                      good performance in school tests, i.e. 100% correct in a test or top ranking in class...; won a prize in a contest of intelligence, mathematics Olympiad, nationwide science contest, nationwide or whole school spelling bee, language contest...; passed the test of gifted students, early admission, honors classes...; elected to be an exemplary student; excellent academic performance, progress in academic performance...</p>	<p>21 (17.4%)</p>	<p>73 (42.9%)</p>
<p><b>2. Achievements Related to HD Goals, including talented performance...</b>                      performed well on stage for piano, violin, flute-playing, or in a play...; won a prize in a contest of paintings, game of go, swimming, calculation using abacus, roller blades, ping-pong, badminton, sprint, race, Taekwando, piano, paintings, flute, singing...; good motor development, good at singing, dance, Logo...</p>	<p>38 (31.4%)</p>	<p>44 (25.9%)</p>
<p><b>3. Appearance</b>                      pretty, good looking, gorgeous, cool, good figure, handsome, cute, big eyes, tall...</p>	<p>12 (9.9%)</p>	<p>6 (3.5%)</p>
<p><b>4. General Cleverness or Ability</b>                      very smart, very clever, creative, talented, gifted...</p>	<p>13 (10.7%)</p>	<p>8 (4.7%)</p>
<p><b>5. Good Behavior and Personality</b>                      very polite, sweet, well-educated, understanding, self-discipline, patient, autonomous, focus...; willing to help,</p>	<p>37 (30.6%)</p>	<p>39 (22.9%)</p>

rules-obeying, willing to share...		
------------------------------------	--	--

The results of  $\chi^2$  analyses found that the ratio of achievements in different categories parents reported was significantly different when their child was in different stage of the development ( $\chi^2_{(4, N=291)} = 25.22, p < .001$ ). Parents with child in middle school mentioned more achievements in VD goals (73; 42.9%) than parents with child in elementary school (21; 17.4%). On the contrary, Parents with child in elementary school mentioned higher ratio of HD goals (38; 31.4%) than parents with child in middle school (44; 25.9%) though the frequency of the latter was a little higher. In addition, parents with younger child also mentioned higher ratio of achievements in Appearance, General Cleverness, and Good Behavior and Personality. The three most mentioned categories of good performance for parents of 8<sup>th</sup> and 9<sup>th</sup> graders to mention were: Vertical Distinctiveness, Horizontal Distinctiveness, and Good Behavior and Personality. However, it became Horizontal Distinctiveness, Good Behavior and Personality, and then Vertical Distinctiveness respectively for parents of 1<sup>st</sup> and 2<sup>nd</sup> graders.

### Discussion

The purpose of study 1 was to examine that whether when children were in different stage of the development, they would perform well in the field of VD and HD differently, especially from horizontal distinctiveness and general goodness to mainly stressing on vertical distinctiveness. The results of study 1 supported this proposition that parents of 8<sup>th</sup> and 9<sup>th</sup> graders mentioned steep higher ratio of vertical distinctiveness than any other type of achievement.

### Study 2: Parents' Reactions to Their Child's Achievement

Different from independent construal of self in which the person is viewed as bounded and unique in relation to others in Western cultures, the self in Confucian societies is more connected to others (Hwang, 2000; Markus & Kitayama, 1991; Sampson, 1988). Because the concept of self is always relational, one's social behaviors, no matter it is an achievement or a failure, also represent glory or shame to his/her "Big Self", the family members (Li, 1993). In other words, a person's achievement is not only his/her own success, but also his/her parents' glory. Studies have found that the achievement motive of people in Confucian societies is social oriented. The goals one will be motivated to be excellent are highly depending on what the whole society expects to him/her, especially from his/her parents' expectation (Yu & Yang, 1987). Iyengar and Lepper' study (1999) did found that,

comparing to their counterparts in Western, Chinese children were more willing to work hard on a task for their parents.

Although people in all societies might experience the feelings of gaining or losing face because of positive or negative social evaluation, face is more an indigenous concept deeply rooted in Confucian culture (Zhang, Tian, & Grigoriou, 2011). Because Confucian societies emphasize the feelings of having face, social comparison is a common phenomenon where people can win face by feeling that they perform better than others. In addition, due to the concept of 'Big Self', one who has any achievement always basking his/her family members, especially his/her parents. Zhai (2004) suggested that the phenomenon of sharing face with important others can be viewed as an extension of one's own face. Actually, sometimes the effects of this reflected glory are more intensive than one's own achievements when the face is earned from one's offspring. The results of Su and Hwang's study (2003) did find that retired people reported experiencing more intensive feelings of having face when their children had achieved accomplishments than they themselves did.

However, since the Eastern cultures value Vertical Distinctiveness (VD) more than Horizontal Distinctiveness (HD), it is very possible that parents would adjust their expectation to their children from appreciate their good performance in both the field of HD and VD goals to lay stress only on VD goals following their children's growing up and facing more stress of academic demands. As a result, especially when children are in high school, a period of very highly stressful for academic performance, parents might feel more proud (having more face) of their children's performance in the field of VD than HD and might have very different reactions when their children achieve VD goals rather than HD. The purpose of Study 2 would like to examine parents' feelings of having face and other related reactions when their high school children were successful in VD versus HD goals and the hypotheses generated were as followings:

Hypothesis 1: Parents will feel having more face when their child achieves in VD goals rather than HD goals.

Hypothesis 2: It is more likely that parents will encourage their child to pursue his/her future career in VD goals rather than HD goals.

Hypothesis 3: Parents will feel more matching their expectation to their child if s/he pursues his/her future career in VD goals rather than HD goals.

Hypothesis 4: Parents will feel more regretful if their child pursues his/her future career in HD goals rather than VD goals.

## Method

### Participants

286 parents of high school students from 5 schools in Taiwan (Taipei) participated in this study; except one who did not identify his/her gender, 72 of them were male (25.2%), and 213 were female (74.5%). Their ages were from 37 to 84 ( $M = 48.16$ ,  $SD = 4.37$ ). Among them, 136 (47.6%) of their child were male and 150 (52.4%) were female.

### Research design

In order to compare the differences in parents' possible reactions to their children's achievement in a VD versus HD goal, we adopted and slightly modified two scenarios (one for VD, and the other for HD) which have been used in other studies. The scenario for VD described a high school student who won the silver prize in a nationwide science contest (Han, 2011) while the one for HD described a high school student won the silver prize in a nationwide singing contest (Han, 2012). Participants were randomly assigned to one of the two versions and were instructed to imagine that the student who won the silver prize in the contest was their child.

### Instruments

**Measures of having face:** Participants were instructed to rate for "If the student who won the prize in the contest was your child, how intensive feelings of having face will you have?" on a 9-point scale (1 = do not have this feeling at all, 9 = feel having face very much) after reading the scenario.

**Measures of other related reactions:** Participants were also instructed to rate for 1. "If the student who won the prize in the contest was your child, will you encourage him/her to pursue his/her future career in this field?" on a 9-point scale (1 = will not encourage, 9 = will definitely encourage); 2. "If the student who won the prize in the contest was your child, does it match your expectation to your child if s/he pursues his/her future career in this field?" on a 9-point scale (1 = not match at all, 9 = match very much); and, 3. "If the student who won the prize in the contest was your child, will you feel regretful if s/he pursues his/her future career in this field?" also on a 9-point scale (1 = will not feel regretful, 9 = will feel very regretful).

When answering the scenario questionnaire, participants were also instructed to indicate their gender, age, and the gender of their child as well.



## Procedures

The two scenario versions of the questionnaire were randomly mixed before they were assigned to participants. Each participant answered one version of the questionnaire only before the PTA meeting held on School Day at high schools.

## Results

Total 302 questionnaires were collected from 5 high schools in Taipei, among these questionnaires, 8 did not answer the checking questions correctly and the other 8 did not complete the questions properly, excluded these questionnaires, only 286 questionnaires were analyzed.

To examine whether parents would have different face feeling when their child achieved in VD versus HD goal, A 2 (achievement Type: VD vs. HD) X 2 (Child's Gender: male vs. female) ANOVA with parents' feeling of having face as dependent variable was conducted. Parents' ratings of having face were presented in Figure 2-1.

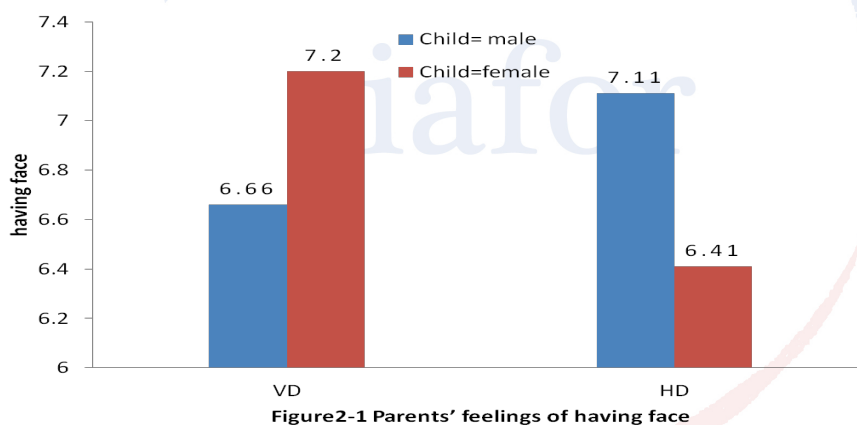

The main effects of Achievement Type and Child's Gender were not significant (Achievement Type:  $F_{(1, 282)} = .58, p > .05, \eta^2 = .002$ ; Child's Gender:  $F_{(1, 282)} = .14, p > .05, \eta^2 = .001$ ); therefore, hypothesis 1 was not supported. However, the interaction effect of Achievement Type and Child's Gender was significant ( $F_{(1, 282)} = 8.25, p < .01, \eta^2 = .029$ ), parents experienced more intensive feeling of having face on their daughter's success in VD and less having face in HD comparing to the same success of their son. This interaction effect would be discussed in General Discussion.

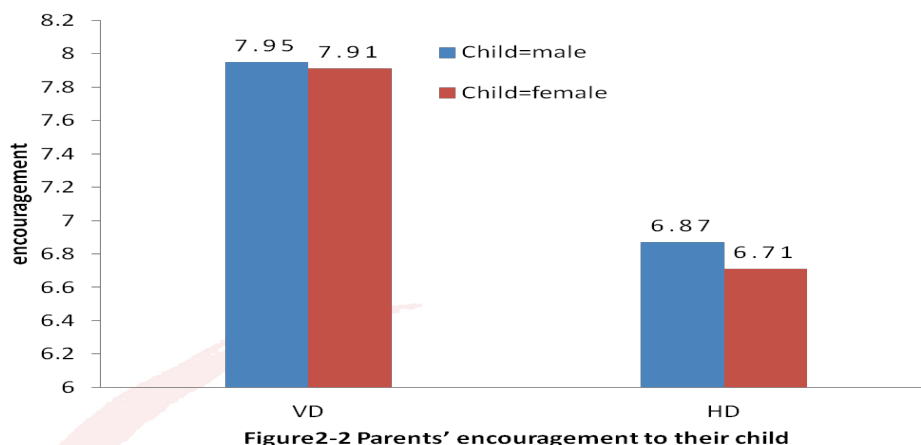

Regarding to whether parents would encourage their child to pursue his/her career in the field s/he won the prize (parents' ratings were presented in Figure 2-2), the results of ANOVA (with Encouragement as dependent variable) showed that only the effect of Achievement Type was significant ( $F_{(1, 282)} = 38.3, p < .001, \eta^2 = .12$ ). It was more possible that parents would encourage their child to pursue his/her future in the field of VD goals than HD. According to this, hypothesis 2 was supported.

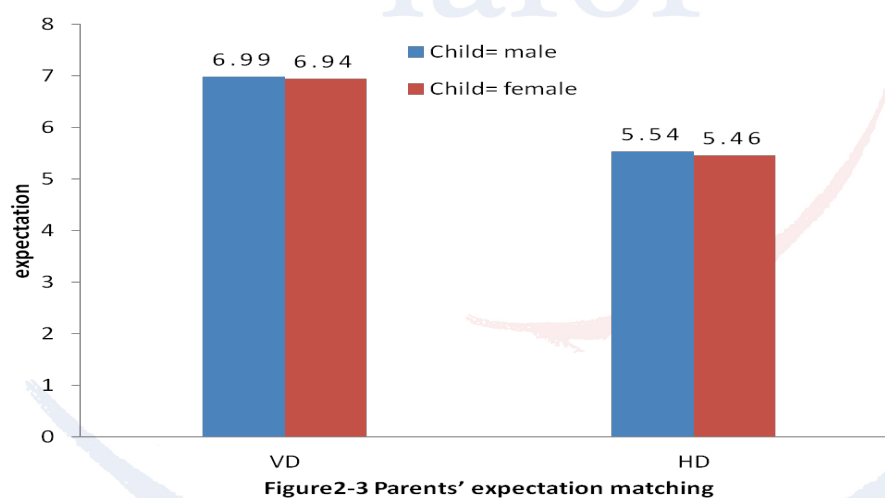

As for whether or not children pursue their future career in the field of their winning prize meet their parents' expectation, participants' responses were presented in Figure 2-3. With Expectation Matching as dependent variable, the results of ANOVA also revealed that only Achievement Type had a significant effect ( $F_{(1, 282)} = 40.19, p < .001, \eta^2 = .13$ ). Comparing to HD, children pursued their future career in the field of VD goals was more matched their parent's expectation. Thus, hypothesis 3 was supported.

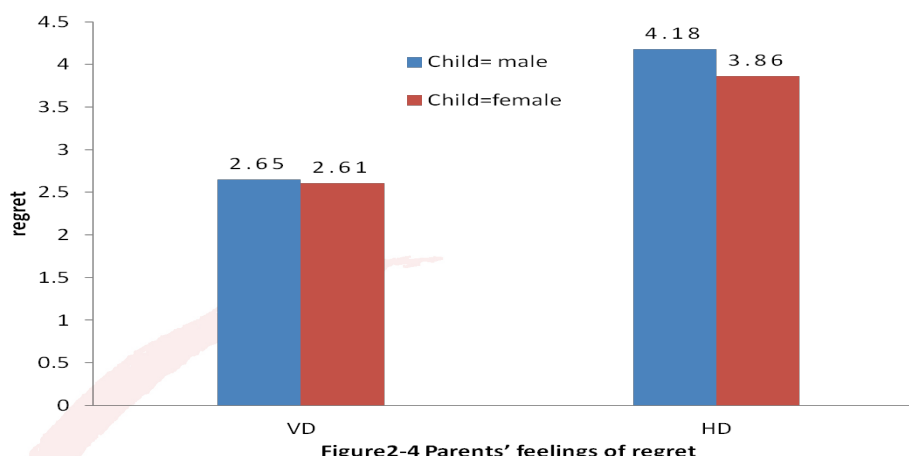

The results of whether participants would feel regretful if their child pursues his/her future in the field s/he won the prize were presented in Figure 2-4. Using the same ANOVA analyzing method with Regret Feeling as dependent variable; again, the results showed that only Achievement Type had a significant effect ( $F_{(1, 282)} = 34.81, p < .001, \eta^2 = .11$ ). Therefore, hypothesis 4 was supported that parents would feel more regretful if their child pursued his/her future career in the field of HD goals instead of VD.

### Discussion

The results of study 2 indicated that comparing to HD goals, when the achievement of participants' child was a VD goal, it would be more likely for them to encourage their child to pursue his/her career in this field. In addition, participants also felt that it would match their expectation if their child decided to pursue his/her future career in this field. On the contrary, participants would feel more regretful if their child devotes his/her future in the field of HD goals instead of VD. Although participants' feeling of having face did not differ when their child had a success in the field of VD versus HD, parents did experience of having more face on their daughter's success in VD goal and less having face in HD goal comparing to the same success of their son.

### General discussion

Study 1 tried to examine that whether children would perform well in the field of VD and HD differently when they were in different developing stages. The results of study 1, from the perspective of parents, did find that 8<sup>th</sup> and 9<sup>th</sup> graders performed higher ratio of vertical distinctiveness than any other type of achievement while 1<sup>st</sup> and 2<sup>nd</sup> graders had more good performance in the field of horizontal distinctiveness (and good behaviors). The results of study 2 found that it would be more likely for

parents of high school students to encourage their children to pursue their career in VD field. In addition, if their children pursue their future career in this field they would feel that it matched their expectation. On the contrary, parents would feel more regretful if their children pursue their future career in HD goals instead of VD. However, parents did experience the same intensive feelings of having face when their children had a success in the field of VD versus HD which did not support our hypothesis.

The insignificance effect of parents not experiencing having more face when their children had a success in the field of VD than HD might be caused by the scenarios. The scenarios designed in this study were describing a high school student who won a silver prize in a nationwide contest. It was reasonable that parents would all feel extremely excited and happy for their children to win such a nationwide contest and rated highly intensive feelings of having face. Future studies can try to adopt more sophisticated methods or design more suitable scenarios to test this effect.

However, there was an interaction effect for achievement type and gender of children, parents felt having more face for daughter's VD success and having less face for her HD success comparing to the same success of their son. It was very possible that this effect was caused by the expectation of suitable social role for different gender (Harrison & Lynch, 2005; Venkatesh & Morris, 2000). Although Confucian societies value VD goals more than HD, VD goals are still more for men to pursue. Comparing to daughters, parents used to expect their son to perform well in the field of VD. If a girl who achieve a VD goal, it implies that she is more excellent than the male; therefore, makes her parents feel having more face.

The results of this study were compatible with the perspective of Hwang et al., (in press) that people in Confucian societies value VD goals more than HD. In addition, because of the social orientation (Yang, 1992) and the concept of big self (Hwang & Han, 2011; Li, 1993) in Eastern culture, parents are more possible to encourage their children to pursue their future career in the field of VD goals rather than HD, this could account for why academic elitism is so prevalent in Taiwan. Children have learned from the process of socialization that they have to endeavor to get into a "good" high school and/or university in order to get into top ranked.

One may argue that the different frequency recalled in VD versus HD goals between 8<sup>th</sup> and 9<sup>th</sup> graders and 1<sup>st</sup> and 2<sup>nd</sup> graders was because that the contents of their daily life were different. For young children, one of the central parts of their everyday life

is to have fun; on the contrary, for elder children who have faced the stress of Entrance Exam of High School, the contents of their everyday life become competing academic performance with others. The purpose of this study was not to deny this phenomenon. Instead, this study viewed this phenomenon as a reflection of social demands on VD and HD. Because Confucian societies value VD goals over HD, children are forced to face competition in the field of VD, and thus, learn to value it.

## Reference

- Chen, T. Y. (1991). Parents: The best counselors of gifted students. *Gifted Education, 61*, 13-18.
- Chiu, Hsin-Yen. (2005). *A study of the relationship among parental expectation, after-school learning and vocational interest for the primary school students*. Unpublished Master's Thesis, National University of Tainan.
- Han, K. H. (2011). The self-enhancing function of Chinese modesty: From a perspective of social script. *Asian Journal of Social Psychology, 14*, 258-268.
- Han, K. H. (2012). The effects of threat of event, closeness, and modesty orientation on college students' interpersonal attribution for horizontal distinctiveness. *Bulletin of Educational Psychology, 43*, 701-716.
- Harrison, L. A., & Lynch, A. B. (2005). Social Role theory and the perceived gender role orientation of athletes. *Sex Roles, 52*, 227-236.
- Huang, Y. W., & Huang, Y. K. (2009). The study of trend of fewer children influences exercise and games curriculum in pre-school and its solution. Paper presented in Conference of College of Exercise and Health Sciences, National Taiwan Sport University, Taiwan.
- Hwang, K. K. (1999). Filial piety and loyalty: Two types of social identification in Confucianism. *Asian Journal of Social Psychology, 2*, 163-183.
- Hwang, Kwang-Kuo. (2005). *Confucian relationalism: Cultural reflections and paradigm reconstruction*. Taipei: Taiwan University Press.
- Hwang, K. K. (2000). Chinese relationalism: Theoretical construction and methodological considerations. *Journal for the Theory of Social Behaviour, 30*, 155-178.
- Hwang, K. K., Chen, S. W., Wang, H. H., & Fu, B. J. (in press). Life goals, achievement motivation and value of effort in Confucian society. In U. Kim & Y. S. Park (Eds.), *Asia's educational miracle: Psychological, social and cultural perspectives*. New York: Springer.
- Hwang, K. K. & Han, K. H. (2011). Face and morality in Confucian society. In M. H. Bond (Ed.), *Oxford handbook of Chinese psychology* (pp.479-498). Hong Kong: Oxford University Press.



- Iyengar, S. S., & Lepper, M. R. (1999). Rethinking the value of choice: A cultural perspective on intrinsic motivation. *Journal of Personality and Social Psychology, 76*, 349-366.
- Li, M. C. (1993). From the results of a justice judgment research to view the interpersonal boundaries for Chinese. *Indigenous Psychological Research in Chinese Societies, 1*, 267-300.
- Lin, H. T. (1993). A research on the process of career development of gifted students in senior high school. *Bulletin of Special Education, 9*, 191-214.
- Lu, Shin-Huei (2003). *The study of comparing messages and sibling relationships: An example of academic performance*. Unpublished Master's Thesis, National Cheng-Chi University.
- Markus, H. R., & Kitayama, S. (1991). Culture and the self: Implications for cognition, emotion, and motivation. *Psychological Review, 98*, 224-253.
- Sampson, E. E. (1988). The debate on individualism: Indigenous psychologies of the individual and their role in personal and societal functioning. *American Psychologist, 43*, 15-22.
- Su, S. Y., & Hwang, K. K. (2003). Face and relation in different domains of life: A comparison between senior citizens and university students. *Chinese Journal of Psychology, 45*, 295-311.
- Tafarodi, R., Marshall, T., & Katsura, H. (2001). Standing out in Japan and Canada. Paper presented in Asian Association of Social Psychology Conference, Melbourne, Australia.
- Venkatesh, V., & Morris, M. G. (2000). Why don't men ever stop to ask for directions? Gender, social influence, and their role in technology acceptance and usage behavior. *Mis Quarterly, 24*, 115-139.
- Yang, K. S. (1992). Social orientation in Chinese societies. In K. S. Yang (Ed.), *Psychology and behavior of Chinese* (pp. 87-142). Taipei: Laureate Book Co.
- Yu, A. B., & Yang, K. S. (1987). Social-oriented and individual oriented achievement motivation: A conceptual and empirical analysis. *Bulletin of the Institute of Ethnology Academia Sinica, 64*, 51-98.
- Zhai, S. W. (2004). The reproduction of favor, face and power: The pattern of social exchange in a ration-affection society. *Research in Sociology, 5*, 48-57.
- Zhang, X. A., Tian, P., & Grigoriou, N. (2011). Gain face, but lose happiness? It depends on how much money you have. *Asian Journal of Social Psychology, 14*, 112-125.

*How to Predict Professional Success in Music and Beyond? Constructing Universal  
Talent's Structure for the Best Vocational Choices*

Dina Kimnarskaya

Russian Gnesins' Academy of Music, Russia

0129

The Asian Conference on Psychology & the Behavioral Sciences 2013

Official Conference Proceedings 2013



iafor

iafor  
The International Academic Forum  
[www.iafor.org](http://www.iafor.org)

Why learn more about human talents? Is it by chance that individual differences in our potential to create, to solve problems or to invest into common knowledge are constantly discussed and researched? And this scientific discourse continues although too many feel opposed to the very possibility of unequal psychological resources leading to inequality of professional choices – society puts too much effort into social piece to let it be threatened by ‘talent concept’. Thus it’s not surprising that for some psychologists ‘road to excellence’ seems to be nearer to ‘hard work’ than to anything else including ‘talent’ [6, 22, 23]. But it’s too tempting to preserve the dream of ideal vocational choice that very well suits our natural predisposition: every human being bears hope for the revelation of his/her natural gifts to become what we must really be – and those who’ve found their talent and developed it to the highest possible level seem to be the first who gain happiness and social respect. Imagine the achievements of society where every person knows from early years in what direction his/her efforts are to be invested most effectively – couldn’t that be the society where no one is dissatisfied with his/her professional outcome? And isn’t it the real goal of psychology to be helpful in finding out what everyone could do best?

As scientists often say, there is nothing more practical than good theory. Do we have a fully admitted ‘talent theory’ relying on true evidence? No. Here is one of very typical descriptions of common feeling among researchers: ‘The great minds of Europe have been pondering the problem of talent—its nature and structure, its origin and development—for some two thousand years now, from Plato and Aristotle to such modern-day psychologists as Sternberg, Csikszentmihalyi, Gardner, Heller and others. But despite their efforts, the problem of talent is far from resolved. An avalanche of publications and conferences notwithstanding, the very concept of talent has become no clearer’.<sup>1</sup> One of the most authoritative scholars in the field Francois Gagné stated that terms and definitions within the emerging theory of giftedness and talent are as many as there are scholars in the field—seventeen chapters of the renowned book on the topic [*Conceptions of giftedness* (1986) (ed. R. Sternberg and J. Davidson). New York: Cambridge University Press] offer seventeen different approaches to terms and definitions: ‘Within that book, no one ever adopts another scholar’s definition; each of them prefers to create his/her own. All these conceptions develop in parallel, without ever confronting their respective contradictions and divergences’.<sup>2</sup> And he is perfectly right as the situation didn’t change much from several decades ago until now (could we forget that his reproach dates back not too far, just 2004?) Everybody might agree that such terms as ‘abilities’, ‘giftedness’, ‘intelligence’, ‘creativity’, ‘talent’ and some others refer to human potential for huge success and high achievement in science, arts, business, sports or other practical matters. And yet dependencies, correlations and interconnections between those psychological traits remain rather vague. In other words, the structure or model of human talent putting all psychological ingredients into correct order is still to be expected.

---

<sup>1</sup> Manturzevska, M. (1994) Les facteurs psychologiques dans le développement musical et l’évolution des musiciens professionnels. In *Psychologie de la musique*, (ed. A.Zenatti), Presses Universitaires de France, p.260.

<sup>2</sup> Gagné, F. (2004) An imperative, but, alas, improbable consensus! *Roepers Review*, 27, p.12.

Let's imagine the structure of talent as it looks now. Psychologists agree that the most visible and important is the difference between psychological instruments aimed at learning and skill acquisition, on one hand, and psychological instruments supporting discoveries, creative enterprises, new ideas, etc., on the other hand [7,8,10,15,18,21,25]. 'The results of a great number of empirical experiments describe a weak correlation between these two types of giftedness'.<sup>3</sup> And a number of researchers also agree that motivation or the desire to excel is so important that it might be included into 'talent's' model [9,16, 17, 26]. If we make a schematic drawing of what we think talent might be, it looks like the following:

### BASIC TERMS OF TALENT'S CONCEPT

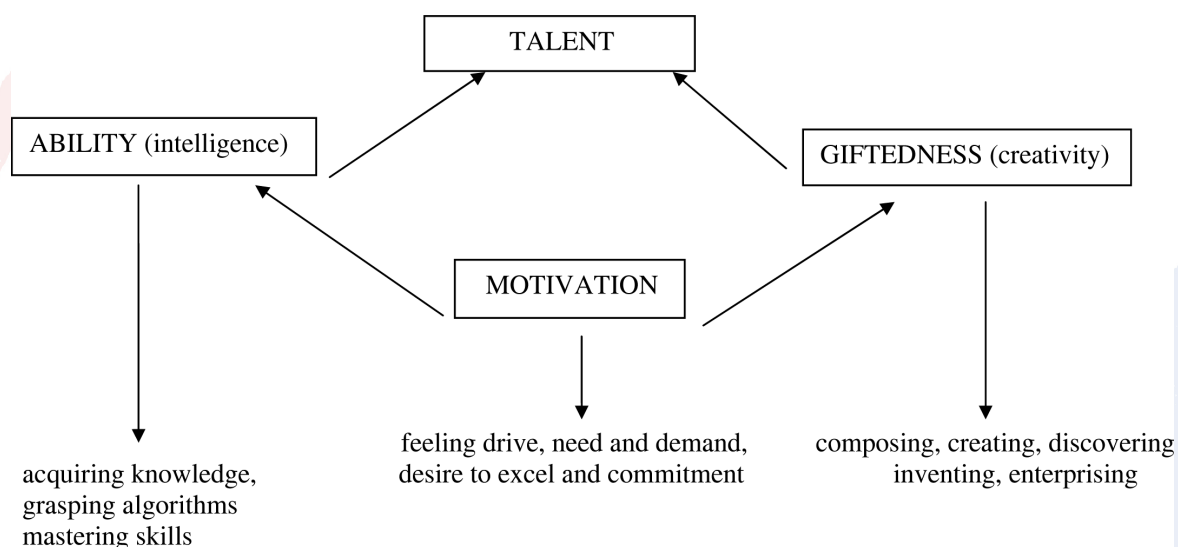

Presumably, talent in any domain roughly looks like this model, consisting of three relatively independent 'ingredients' – ability, responsible for educational part of high results in any domain, giftedness, responsible for creative part, and motivation, responsible for desire to excel in the domain. Yet it is hardly possible to come up with effective help in vocational choices using this model. In the same way as IQ or creativity concept, it is also non-specific: it doesn't give a clue to testing procedures aimed at giving professional directions for anyone, be it a child, a teenager or a youth. How we construct tests for future engineers or IT-specialists, how we know whether her or his path in life is connected with law, or may be with medicine, or with dance? To know this, we are to connect abstract psychological categories with concrete operations of mind, ways of thought and types of action being vital for this or that occupation.

Do we have a concrete talent's model for any of the domains? A model using certain psychological categories and also explaining how to make this model work for practical purposes? The answer is 'yes'. We have at least one successful attempt

<sup>3</sup>Siegler, R. S. and Kotovsky, K. (1986) Two levels of giftedness: shall ever the twain meet? In *conceptions of giftedness*, (ed. R. J. Sternberg and J. E. Davidson). Cambridge University Press.

of building a model for one talent, and that is musical talent; its model is already being used as a prediction tool for analyzing people's musical future [8, 10, 12, 13]. It's hardly surprising that music is the first: wasn't it music that during centuries denied everyone the possibility of becoming a renowned composer or acclaimed instrumentalist? The very idea of exceptional abilities, giftedness and talent was always alive among musicians. Weren't it also musicians that made attempts to predict children's musical career having the possibility to compare successful and unsuccessful predictions done in the past? And don't we have the most detailed scientific ground – cognitive psychology of music and neuropsychology of music – to rely on when researching all aspects of interaction between our mind and music including exceptional abilities to perform and compose?

The structure of musical talent is presented below. All three components of any talent's model are there. Motivation is embodied through *expressive ear* for music – a special type of perception when the meaning of musical message together with its emotional essence causes recipient's empathy and understanding. Ability (or musical intelligence) is presented by traditional features, such as sense of rhythm, pitch and musical memory. Musical ability as a whole including its sub-components is called *analytical ear* due to its function: to analyse musical material knowing each element's role in the system of organizing sounds in time (rhythm) and 'space' (pitch). And finally, *compositional giftedness* (or creativity) that is a necessary part of any musician's talent including that of performers, carries two 'blocks': *architectonic ear* looking after the integrity and esthetic perfection of musical text, and *musical imagination*, giving life to musical elements – sounds, motifs and phrases to be accepted or denied by architectonic ear.



## MUSICAL TALENT'S STRUCTURE

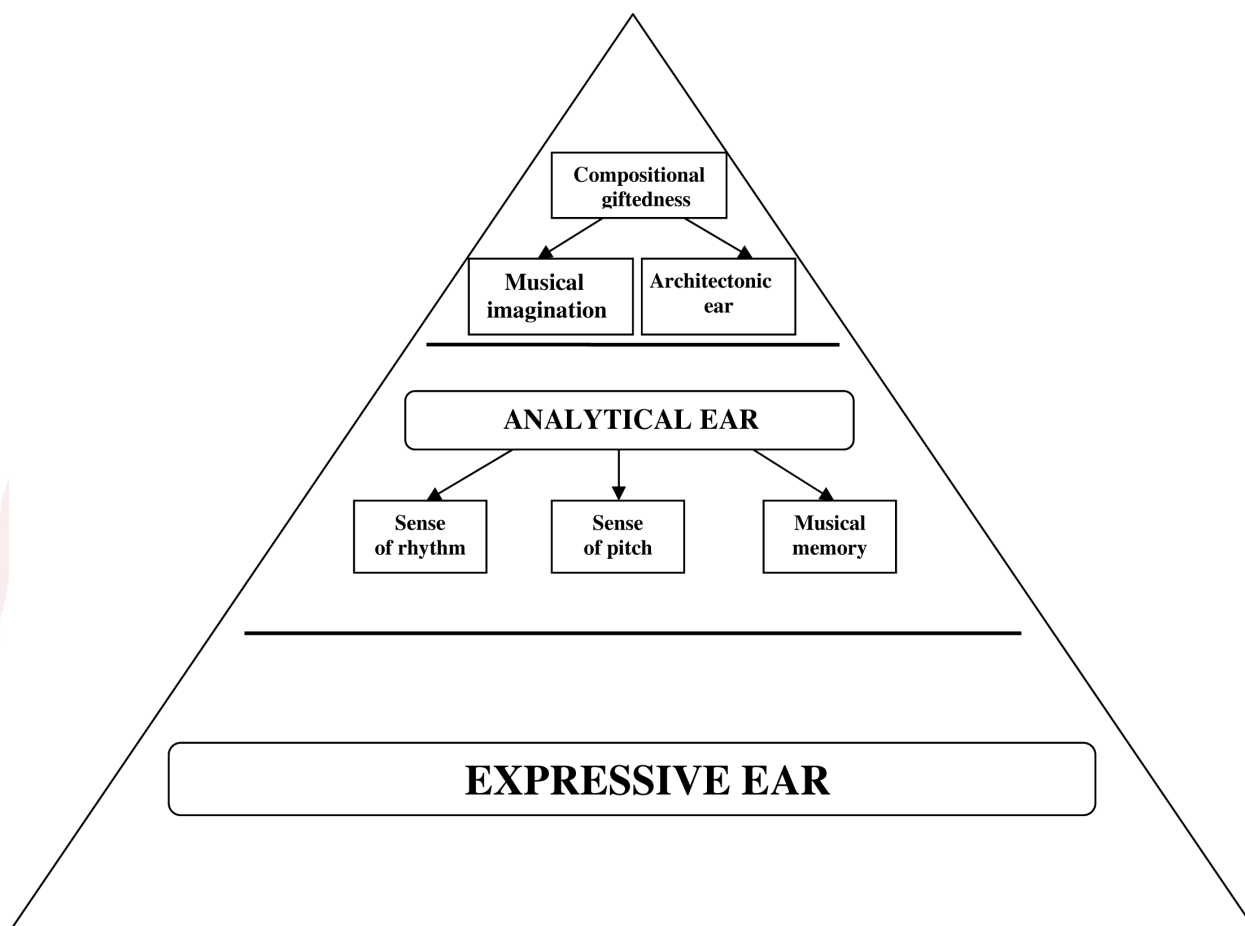

What this more detailed talent's structure is giving us? It is telling us how levels of musical talent differ, i.e. what psychological predisposition is needed for musical amateur versus just music lover and, further on, what is the difference in musical potential between someone who is ready to play and sing at home in contrast to someone else who gives a hint of becoming a professional performer, singer or composer. Here are some practical achievements where musical talent's structure happened to be a clue: several types of testing tools have been invented and put into practice, and all of them turned to be very useful for music teachers, music schools and individuals. Basically, they are tests where the subjects just listen to some real musical excerpts, compare them and make their choices (all the tests are done in groups, they take about 10-15 minutes and do not demand any special education from a person who administers them). As a result it becomes possible: 1) to discover a future music lover in a child and thus invite her/him to music school (according to longitudinal study done from 2001 to 2009 with 10.000 Moscow first-and second-graders these children don't drop out) [8]; 2) to give the opportunity to those with professional music potential to reveal it and choose a career in music if they'd like to

do so [11,13]; 3) to pinpoint future winners of music competitions in advance before the competition starts; 4) to predict future success or failure of musical prodigies when they are still before their teens[8,9].

There are some other outcomes from broad experimenting with musical tests showing how far one's musical talent is developed. It turned out that: 1) the structure of musical talent is based on phylogenetic process – the aspects of talent lying 'lower' in the talent's model are older than those lying 'higher' – expressive ear happened to be born much earlier in the course of human evolution than analytical ear, and the youngest are the most sophisticated aspects of talent – architectonic ear and imagination; 2) the 'lower' lies psychological category as part of talent's model, the more people are blessed by possessing it: there are more people ready to become happy listeners and music lovers than active music amateurs, and there are more people blessed with enough musicianship for amateur musical entertainment than for professional career in music. The proportions between those groups for general population, i.e. for children and unselected adults, are the following: about 12% - music lovers' group, 7% - amateur group, 2, 4% - professional group; 3) each stage of talent's development includes previous stages – music amateurs are recruited out of music lovers and music professionals are to possess aspects of talent that characterize all previous stages – both expressive and analytical ear; 4) the natural development of musicality is to repeat the stages that humanity passed through on its way to fully developed musical talent – knowledge and skill representing the lower stages of talent's development are to be the first in education and training, higher stages are to appear later in the educational process, following the same order they've appeared in human evolution.

The tests' battery relying on musical talent's structure predicts how likely is musical success for any child, teenager or adult, and this battery is broadly used by educational institutions and individuals. Could the structure of musical talent, now experimentally supported by much evidence, become an example for constructing a model for other talents, and thus, in the end, helping people to better understand their strengths and possibilities? Positive answer to this question seems the most likely. Due to research process for musical talent's construction it's more clear where and how to look for each of any talent's parts and elements.

Speaking about 'other talents' we don't have in mind the endless amount of talents needed for each and every profession. It could take centuries to research and understand all of them remembering that every new generation is to face new occupations that appear due to new technologies and new social demands. And yet contemporary psychology has the answer to the simple question: how many talents humans have? Basically, only nine. Just nine – that's the answer of Howard Gardner, the author of 'Frames of Mind' who offers the new philosophy of giftedness 'outside IQ' [4, 5]. He was the first to proclaim 'multiple intelligences' approach stating that we've gained in the course of evolutionary development nine intelligences none of which equals 'general intelligence', 'creativity' or any other psychological definition. These 'intelligences' are: bodily-kinesthetic, spatial, natural, verbal, logical-mathematical, musical, spiritual, inter-personal and intra-personal. Like all colors are born from a certain mixture of spectrum colors, all our talents are formed out of Gardner's nine 'intelligences'. It's enough to know the structure just of these nine –

one of them is ‘musical’ – to be able to present any special psychological demands for any human occupation. So, we have only eight talents left...

Humans as everything and everyone in Nature are built according to the Natural Law of Harmony: symmetry, analog, correspondence, equivalence, isomorphism, etc. rule our World. From that standpoint talent for music is analogous to any other talent and all of them have similar structural elements for similar functions. Where to look for Motivation that is the energy center of any talent, its motor, its stimulation mechanism, making it work? According to music, expressive ear had been born out of sound signals helping human species survive exchanging emotionally meaningful information. Can we see what circumstances gave birth to another talent? How the activity where this talent had been so necessary supported the survival of our very remote ancestors? What psychological equipment was vital when this activity had just started its way through human civilization? These are the questions we are to pose and answer to be able to find any talent’s motivation center.

The second ‘floor’ of musical talent is analytical ear that is its ‘operational center’. Isn’t it logical to imagine operational center of any talent to be functionally similar to analytical ear in music? Ear for music (pitch) and sense of rhythm give way to musical language formation: to segmentation of musical flow, to organizational systems like modes and keys for sounds and groups of sounds, to different functions for those sounds and sound groups, to diverse patterns and ‘gestalts’ for them. Do other activities form their own ‘languages’? Mostly the answer is ‘yes’. If so, then what must be psychological apparatus making possible mastering of those ‘languages’? How our mind approaches these ‘language-like’ processes in other activities and makes sense of them – that is the question to be answered in search of analytical ear’s analog in the structure of other talents.

And, finally, the third and highest ‘floor’ of musical talent has two ‘blocks’: one for delivery of new melodies, sound complexes, phrases, etc. and the other for esthetic judgement of them to accept those corresponding to artistic idea of a certain piece and to reject those falling out of its style and breaking its integrity. And what about other talents? Is there any ‘holistic idea’ when we build an air-craft, create a costume or deliver a lecture? Certainly, yes. Outside art and music human talents let us invent many new elements and patterns needed for any type of construction from a novel to computer program and yet those talents don’t let our ‘composition’ turn into ugly mess. Always and everywhere talented person looks for and finds harmony, beauty and perfection appearing due to strict choice of necessary elements out of many more unsuitable and inappropriate ones. Isn’t that any doubt that talents outside music also carry in their ‘creative block’ the same two ‘operators’: an operator of productivity or, in other words, imagination and an operator of harmony and proportionality?

Let’s try to draw a preliminary structure of any talent where functions of its parts and aspects in the talent’s ‘organism’ are to some extent clear, but we still have to find out the rest.

## TALENT'S STRUCTURE

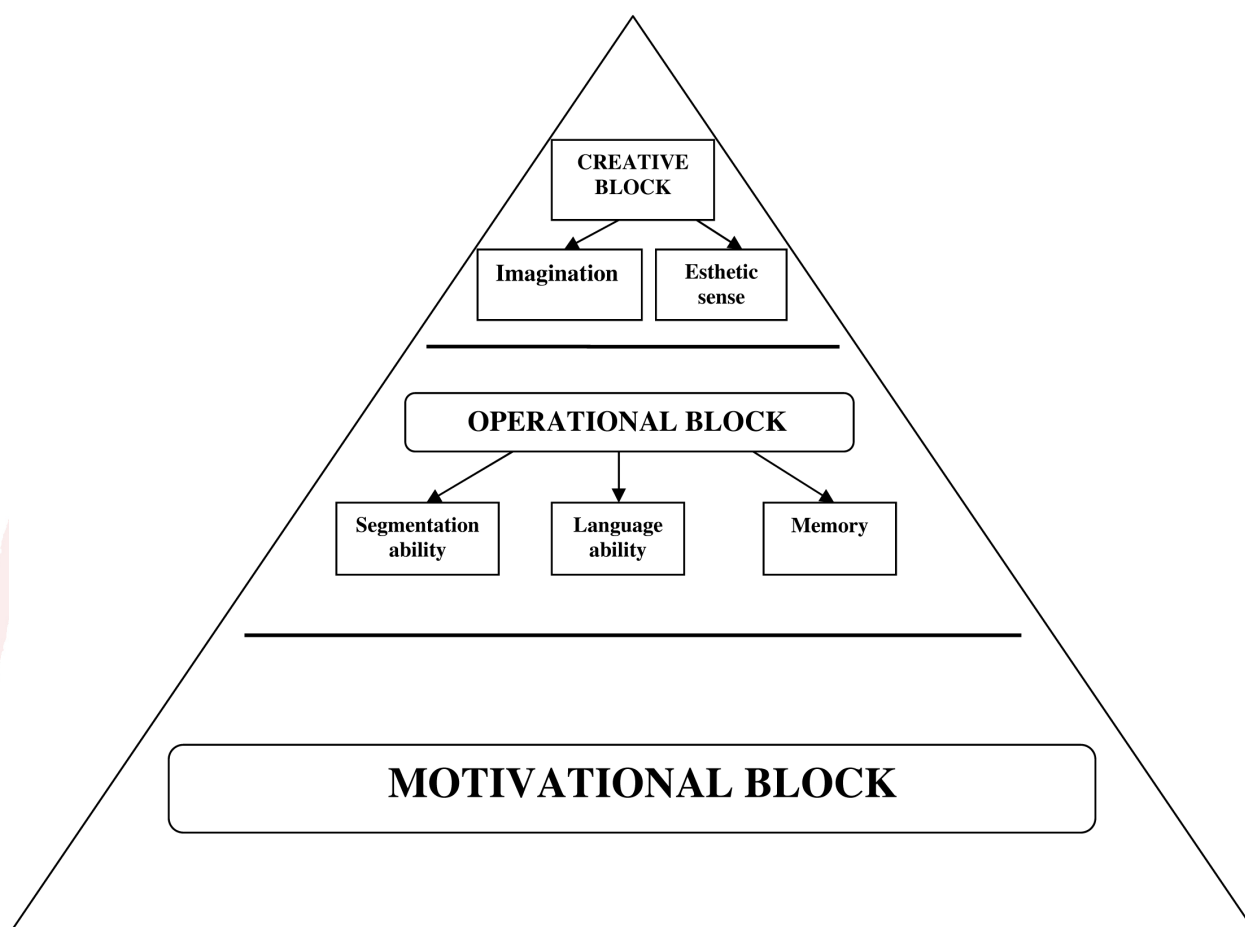

When all Gardner's 'talents' reveal their structure, when we know more about motivational, operational and creative parts of them, the time comes for the construction of tests for the same purpose as it had been done in music, i.e. for finding for all of us whether this or that talent is truly 'our cup of tea'. Music prompts that it will be possible to do during any child's early years – before 10 years old.

Universal test battery for all nine 'talents' found by Howard Gardner – is there more tempting task for psychology? There is hardly anything more effective from business point of view: to increase 'human capital' to the highest possible extent by giving everyone her/his appropriate occupation. Research expenditures that are needed to make this 'dream' possible are very little compared to any other technological or industrial project. Isn't it time to make the first step to super-effective society full of happy individuals having realized and put to common good their diverse talents?

## REFERENCES

1. Ceci, S. J. and Liker, J. (1986) A day at the races: a study of IQ, expertise and cognitive complexity. *Journal of Experimental Psychology: General*, 115, 255-66.
2. Gagné F. (2004a). An imperative, but, alas, improbable consensus! *Roeper Review*, 27, 12-14.
3. Gagné, F. (2004b). Transforming gifts into talents: the DMGT as a developmental theory. *High Ability Studies*, 15, 119-41.
4. Gardner, H. (1997) *Extraordinary minds*. New York: Basic Books
5. Gardner, H. (1983) *Frames of mind*. London: Heinemann.
6. Ericsson, K. A., Charness, N., Feltovich, P., and Hoffman, R. R. (eds.) (2006) *Cambridge handbook of expertise and expert performance*. Cambridge, UK: Cambridge University Press.
7. Ilyin, E. (2004) *Psikhologia individualnikh razlichii/The Psychology of Individual Differences*. St.-Petersburg: Piter.
8. Kirnarskaya, D. (2009) *The Natural Musician: on Abilities, Giftedness and Talent*. Oxford University Press, Oxford, UK.
9. Kirnarskaya, D. (2006) *Teoreticheskie osnovy i metody otsenki muzikalnoi odarennosti/Theoretical Foundations and Methods of Testing of Musical Giftedness*. St.Petersburg: St.Petersburg University.
10. Kirnarskaya, D., Winner, E. (1999) Musical Ability in a New Key: Exploring the Expressive Ear for Music. *Psychomusicology*, 16, 2-16.
11. Kirnarskaya, D. (1995) Music-language ability as a component of musical talent. In *The First East-West Conference in General Psychology*, pp. 298-303. Banska Bystrica: Matej Bel University.
12. Kirnarskaya, D. (1992) Opyt testirovaniya muzykal'noi odarennosti na vstupitel'nykh ekzamenah/Musical giftedness' testing at the conservatory entering examinations. *Voprosy psikhologii*, 1-2, 158-63.
13. Kirnarskaya, D. (1989) Muzykal'no-yazykovaya sposobnost' kak komponent muzykal'noi odarennosti/Music-language ability as the component of musical giftedness. *Voprosy psikhologii*, 2, 47-56.
14. Kirnarskaya, D. (1988) Sovremennye predstavleniya o muzykal'nykh sposobnostyakh/Contemporary views on musical abilities. *Voprosy psikhologii*, 2, 137-47.
15. Krutetsky, V. (1998) *Psikhologia matematicheskikh sposobnostei shkolnikov/The psychology of schoolchildren's mathematical abilities*, Moscow: Institut prakticheskoi psikhologii, p.27-28.
16. Manturzevska, M. (1994) Les facteurs psychologiques dans le développement musical et l'évolution des musiciens professionnels. In *Psychologie de la musique*, (ed. A.Zenatti), Presses Universitaire de France
17. Renzulli, J.S. (1978) What Makes Giftedness? Reexamining a Definition. *Phi Delta Kappan*, 60(3), 180-84, 261.
18. Siegler, R. S. and Kotovsky, K. (1986) Two levels of giftedness: shall ever the twain meet? In *Conceptions of giftedness*, (ed. R. J. Sternberg and J. E. Davidson). Cambridge University Press.
19. Simonton, D.K. (1999) Talent and its development: an emergenic and epigenetic model. *Psychological Review*, 106 (3), 435-57.
20. Peretz, I. (2006) The nature of music from a biological perspective. *Cognition*, 100, 1-32.
21. Petsche, H. (1996) Approaches to verbal, visual and musical creativity by EEG coherence analysis. *International Journal of Psychophysiology*, 24, 145-59.



22. Sloboda, J. A. (1996) The acquisition of musical performance expertise: deconstructing the 'talent' account of individual differences in musical expressivity. In *The road to excellence: the acquisition of expert performance in the arts and sciences*, (ed. K. A. Ericsson). Erlbaum.
23. Sloboda, J. A., Davidson, J. W., Howe, M. J. A., and Moore, D. G. (1996) The role of practice in the development of performing musicians. *British Journal of Psychology*, **87**, 287-309.
24. Torff, B. and Winner, E. (1994) Don't throw out the baby with the bath water. *The Psychologist*, **7**, 361-2.
25. Winner, E. (2000) The origins and ends of giftedness. *American Psychologist*, **55**, 159-69.
26. Winner, E. (1996) Gifted children. New York: Basic Books.
27. Winner, E. (1996) The rage to master: the decisive role of talent in the visual arts. In *The road to excellence: the acquisition of expert performance in the arts and sciences*, (ed. K. A. Ericsson). Erlbaum.

The logo for 'iafor' is centered on the page. It consists of the lowercase letters 'iafor' in a light blue, sans-serif font. The text is enclosed within a large, light blue circular arc that is partially obscured by a larger, fainter light blue circle. A red brushstroke-like arc is also visible, overlapping the blue circles and the text.

## *Holistic Theory of Behaviour*

Surendra Nath Dubey

Ram Manohar Lohia Avadh University, India

0148

The Asian Conference on Psychology & the Behavioral Sciences 2013

Official Conference Proceedings 2013

### Abstract

The objective of the study has been to develop a Holistic Theory of Behavior, to test the theory on Indian and foreign samples and to test the application of theory in changing, predicting and controlling behavior. The scientific method for the development of theory stems from the natural sciences and adopted by the Bunge and Ardila (1990). The theory put forth many psycho-socio-cultural determinants of behavior. Genetic factors are crucial in building base for the behavior to grow in cultivating milieu of psychological, cultural and social factors. Development of Behavior takes place in **five** stages: **Stage I**(0 to5years) in which culture and tradition of the family (*Sanskar* and *sanskriti* coming to the child in the form of child rearing practices in particular culture) give thrust for the development of a unique behavior pattern of the child. **Stage II**:age 6 to12 years besides food and water, safety, health, clothing, and education, is the prominent factors determining the behavior. **Stage III**: age 13to18, sex, power prestige, safety and education are the dominant determinants of the behavior. **Stage IV**: 19 to 50 years, again sex along with money, power, caste, religion, prestige, quality of food intake, thought process, the organization in which a person works, proverbs, sayings in the society, literature (like *Shrimadbhagawatgeeta,Shri Ramcharitmanas*) and place of residence are the directing force for the development of behavior. **Stage V**: Religious beliefs and practices and life time experiences are dominant determinants of behavior during this stage spreading from above 50 years till the end of life.Any behavior, adequate or inadequate, desirable or undesirable is facilitated and strengthened by reinforcement. Most of the unwanted behavior is learnt by the individual through Faulty Reinforcement System (a model developed by the author to explain undesirable behavior in Indian (Dubey,1992) society. *We come to* the conclusion that the most important determining factors of any behaviour are: Sex, Anger, Greed, Ignorance, Arrogance, Love, Affection,Compassion,Hunger, Jealousy, Money,Status,Power,Family Variables such as;, Culture, Caste and Religious practices, Behavior of Leaders in the organization and Behavior of Political and Religious Leaders . There are **five** factors that prepare the **base** for the change and control in behavior are: *Vivacity, Attitude, Discipline, Determination, Trust and Unconditional surrender to Almighty* . Control in behavior and desired change can be achieved at 3 levels: Level 1: Stimulus –response level; by the process of reinforcement.Level 2: Cognitive level; through cognitive behavior intervention. and Level 3: Internal level; through *Yoga*. There can be **4** factors that prepare the **base** for the change and control in behavior:Knowing one’s strengths; Understanding one’s weaknesses; Leaving behind one’s greed and arrogance; Developing Truthfulness, Tolerance, Compassion and Non –violence. The last factor is the most prominent for the change in any behavior. It affects at internal and implicit level and can be achieved easily through Yoga Science. Change in behavior would lead to a world free from drug, disease, violence and corruption.

**Key Words:** Theory, Behavior, Yoga.

iafor

The International Academic Forum

[www.iafor.org](http://www.iafor.org)

## Introduction

*The behavior of a person is the mirror of his nature: Anonymous*

Psychologists have defined Psychology as ***the Science of observable behavior***. Thus, the behavior is considered to be an overt activity of the organism. As a result, many of the studies in psychology remained restricted to overt activities of an organism for many years. But today, we are interested in studying mental processes as well as the behavior. Not only that, we also try to explain human behavior in terms of mind involved in it. Since *mind* instructs the body to behave in a definite way, any resultant behavior have a minimum of two aspects the *physical* and the *mental*. In order to have an effective behavior, we try to maintain a balance between the two depending upon our:

- Socio-cultural background
- Relationship with others
- Situation in which we are behaving, and
- An imagination about the outcome of the particular behavior.

In this process, the effective behavior in which mind and body work together without dominating upon each other becomes *spiritual* in nature due to Gestalt effect (Sharan, 2004). We can take an example of experimenting love in a laboratory. It is a fact that by putting love under scientific scrutiny we are destroying its mystery. In reality love includes tenderness and toughness, excitement and boredom, affection and anger, stability and change, bond and freedom etc. This cannot be known by any scientific method. As a result, the researchers who have tried to know about it by using all sorts of sophisticated instruments, have found it to be a *triangle* of which the three sides represent physiological, psychological and anthropological factors. But, outside the laboratory, the true love has emerged as a *circle* which combines all the three kinds of factors into one. This organization as a whole is known as *spiritual love* in which all the parts merged with each other. This is a nice blend that no factor is dominating upon anyone. This kind of true love cannot be analysed but can be experienced. Like this every human behavior needs to be effective (spiritual) and to be understood finally by experience not by the familiar methods of experimentation and testing.

In any science, the methods of investigation depend largely on the subject matter. Accordingly, like all scientists, psychologists construct theories that organize observations and imply testable hypotheses. Psychologists use several methods, viz.; Introspection, Observation, Questionnaire, Survey, Case study, Testing and Experimentation. Every method has been found to be useful, but at the same time have certain limitations. Even the experimental method, which is considered to be the ultimate method in Scientific Psychology, is subject to certain serious objection: For many thoughtful researchers the idea of applying science to human affairs raises concerns about how well experiments relate to life, how experimenters treat human and animal subjects and how their values influence their work and its applications (Myers, 1986). In such situations, as suggested by Mc Dermott. (1970), Fitz (2001) and Denning (2001) *Intuition* can be a very useful and perhaps the only method in some cases, in Psychology. We all have this system but the irony is; we have not learned how to use it fully: We just need to recognize it, to tune it in to our intuition (Clare, 2003). According to Denning (2001) everyone has intuition, we cannot live without it. It is just more highly developed in some people than in others. Most people are unaware of their intuitive

abilities and therefore, do not use them to their advantage. Even Einstein, one of the towering geniuses of modern time once remarked that the intuitive mind is a sacred gift and the rational mind is a faithful servant. We have created a society that honours the servant and has forgotten the gift.

Day (1996) while defining intuition as a nonlinear and non-empirical process of gaining and interpreting information says that intuition responds to questions. All our senses: sight, touch, hearing, smell and taste respond to the questions our environment or body machine pose. Our rational mind interprets the information provided by these senses for more efficient survival. The intuition's function is to bring to consciousness that information which lies beyond what our rational mind perceives from our five senses: about the people we do not know, places we have not been to or the future.

- *But intuition sometimes poses dangers, being difficult for scientific testing and very close to common sense.*
- *Thus, it should not be misunderstood that we are advocating intuition as a scientific method.*

Therefore, Psychology began as the study of consciousness, and then turned to the study of observable behavior. Today it is the science of both: Behavior and mental processes. Thus, what psychology lost once, is gaining again with renewed vigour in the name of mental processes (Myers, 1986). In the beginning, the difficulty of studying consciousness scientifically led psychologists to turn to direct observations of behavior. But by 1960, advances in neuroscience made it possible to relate brain activity to various mental states - waking, sleeping, and dreaming. As a result, today many psychologists are affirming the importance of mental processes and are looking afresh into the power of infinite mind.

The nature of human mind is very difficult to understand because it is very subtle as well as hidden. Therefore, it has been defined by different thinkers in different ways. Since Freud originally defined the structure of personality in terms of unconscious, subconscious and conscious. We psychologists have also been talking about the same topographical model all these years. *Conscious* as the part of psyche includes material of which one is fully aware. *Subconscious* (preconscious) as the part of the psyche that includes material which is not at the moment within one's awareness, but can readily be brought to the conscious mind and *Unconscious* as the part of the psyche that includes material not within awareness and which cannot readily be brought to the conscious mind (Ewen, 1980). Thus, under the influence of Freud, We have been recognizing unconscious, subconscious and conscious factors as significant determinants of human behavior. Not only Freud's views but there can be many other factors, viz.; socio-cultural, relationships with elders and youngsters, developmental patterns and rearing practices, the situation (condition) in which the person is behaving, the person from whom one got the stimulus to behave etc. play vital role in deciding a person's behavior pattern.

In scientific research the aim of a scientist is not simply to describe a phenomenon but to explain it as well, e.g. a Psychologist studying behavior is not content only to explore and describe behavior in different conditions; as a scientist the psychologist also wants to be able to explain why such behavior occurs.

To accomplish this task, scientists in all fields of study engage themselves in the construction of theories. Theories: are *a framework for explaining events or processes* (Baron and Kalsher, 2013). The procedure involved goes something like:

- On the basis of existing evidences a theory is formulated.
- The Theory, which consists of some basic concepts and statements about how these concepts are related, helps to organize existing information and also makes predictions about observable events.
- These predictions, also known as Hypotheses are then tested by actual observations.
- If the results of new observations are consistent with the theory, confidence in it is increased; if not theory is modified and further tests of its predictions are performed.
- Finally, the theory is either accepted or rejected as accurate.
- Even if it is accepted as accurate, it remains open to further refinement as additional research is conducted.

Following diagram presents the Role of Theory in Psychological Research  
(Source: Baron and Kalsher, 2013):

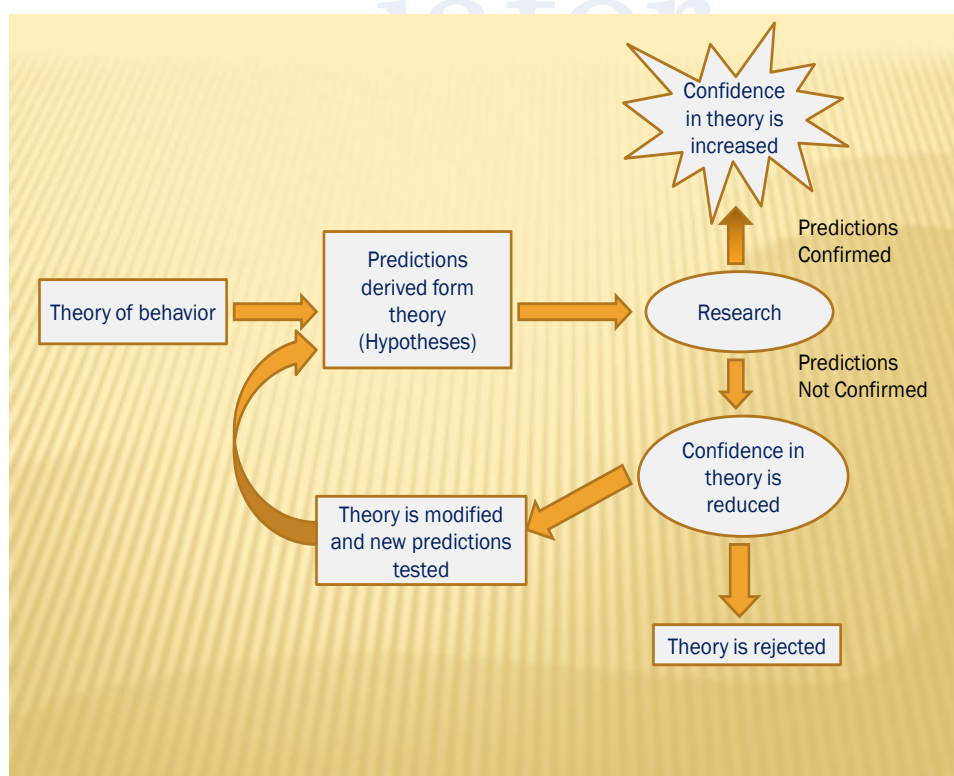

### Origin of Research Problem:

Why do different persons respond differently to the same stimulus in same situation? Why does a person react differently to the same stimulus in different conditions? There can be a



simple answer to these questions that an individual's reactions and behavior is determined by his/her personality pattern. Dubey (2004) has explained that it is not only personality that determines one's behavior but some other factors; e.g. social relationships, past experience, cultural and family background, the situations in which the person is reacting etc. determine one's unique reaction and behavior pattern.

An individual goes through numerous experiences during their developmental stages. They learn to behave, learn to change behavior and modify throughout their lives. The factors that determine the behavior pattern change and modification in it, is to be extensively researched. There has been no research till date that presents a complete set of variables which may determine behavior patterns of an individual in different situations. There has also been no theory of behavior. The development of psychological techniques of crisis management has also not been taken. Due to lack of crisis intervention techniques the psychologists are not equipped with and not capable of dealing with the psychological problems at individual, community and society levels effectively.

Psychologists are also not in a position to reveal the unconscious and subconscious world of the people. If we can reveal the unconscious and subconscious aspect of one's behavior it will be a great help to the psychologists in *predicting, controlling* and *modifying* the behavior. It will also help in guiding the people to exert satisfaction from jobs and utilize their full potentials.

The proposed area of research is comparatively empty. There are few models of behavior. One such model was presented by Triandis (1977), a model of social behavior which is a broad framework designed to permit the understanding of what determines a behavior. The general purpose of this model is to highlight the major contributing components that must be considered while measuring and evaluating a motivated social behavior.

The other model of behavior was presented by Graham (1950) in terms of general equation of behavior.

$$R = f(a, b, c, \dots, n, \dots, t, \dots, x, y, z)$$

Where R stands for response or behavior, a, b, c, for some aspect of stimulus, n for the number of times the stimulus is applied to an organism, t for time, and x, y, z for internal conditions, motivation etc.

The two *models* of behavior described above present a view of the determinants of behavior but not a theoretical framework to explain, control and predict the behavior. The factors that determine the behavior pattern change and modification in it, is to be extensively researched. *This had incited the researcher to work for the development of the theory of behavior.*

### **Objectives:**

- To develop a Holistic Theory of behavior.
- To test the theory on a sample across the globe.
- To test the application of theory in change, prediction and control of behavior.

### **Method**

#### ***Development of Theory:***

The scientific method for the development of theory stems from the natural sciences and adopted by the Bunge and Ardila (1990) was followed for the development of the theory of Behavior. The procedure (steps) sketched in following figure 1 presents an scheme for the development of theory (cf. Sedlmeier, 2004):

Formulation of Theory  
Hypotheses/Question  
Operationalisation  
Design of Study  
Getting Data  
Analysis of Data  
Interpretation of Data  
Implication for Theory  
**THE THEORY**

*Figure 1: Scientific method as commonly applied in academic psychology.*

The starting point in the development of a theory is hypotheses/questions followed by the operationalisation of concepts, variables etc. Then comes design of the study, the method used for the collection of data, analysing data, interpretation of results, implication for theory and finally the development of the theory. This procedure will be followed in the proposed research project.

***Methods used for Data Collection:***

The following methods were applied for the collection of data in this research:

- Observation (participant/non-participant) in natural condition.
- Interview
- Case study
- Introspection
- Intuition

***Sample of the Research:***

A total of 595 subjects were selected depending on their willingness to participate in the research consisting of persons from different walks of life and different parts of following countries:

- U.S.A.,U.K., France, Switzerland, Italy,
- Japan,India, Indonesia, Malaysia,
- Singapore, Thailand, U.A.E.,
- Ethiopia and Egypt.

Table 1: The structure of sample indicating the number of subjects from different countries and in various categories.

Gr	India	Ethiopia	Egypt	Indonesia	Malaysia	Singapore	Thailand	U.K.	U.S.A.	France	Switzerland	Italy	Japan	U.A.E.
C	50	06	-	-	-	04	-	01	02	03	05	02	01	-
A	65	30	06	10	-	-	04	03	10	02	07	09	06	08
Ad	200	25	12	15	10	08	06	10	20	08	15	08	12	12
U	185	50	16	20	10	12	10	14	30	13	27	19	19	20
R	130	11	02	05	-	-	-	-	02	-	-	-	-	-
G	40	05	-	-	-	-	-	01	06	03	07	04	02	06
I	10	-	02	-	-	-	-	-	01	-	-	-	-	-
T	25	06	04	05	05	04	04	05	05	03	04			
M	20	-	01	-		01	-	01	01	-	02	01	02	-
P	30	-		-	-	-	-	-	-	-	-	-	-	-
R	15	04	02	-	02	02	01	01	-	-	-	-	02	-
Tc	60	10	03	10	03	01	01	02	07	02	02	03	06	06

Gr=Groups, C=Children, A=Adolescents, Ad=Adults, U=Urban, R=Rural, G=Government Officials I=Industrialists, T=Traders, M=Media people, P=Politicians, R=Religious Leaders, Tc=Teachers.

An attempt was made to observe the behavior in natural settings. Interview, case study, Introspection and Intuition were also applied.

### Secondary Sources:

For the development of a theory, secondary sources such as published researches, books, reports etc. play an important role. In the proposed research the published sources, viz; Shri Ramcharitmanas (Goswami Tulasidas, 2013), Shrimadbhagawatgeeta (Goy anaka, 2013), poetry of Kabir, Rahim, Surdas (Pandey, 2007), proverbs and sayings describing human behavior were reviewed and relevant information were collected and testified. **The Indian literature (e.g. stories of Munshi Premchand), Customs, rituals and cultural and archaeological heritage describe the whole psyche of the individuals if researched and scientifically presented and verified.** An attempt was made in the proposed research to scientifically review, verify and testify about what has been said in our literature about the behavior of the people.

### Tools used:

The following tools were used to collect the information regarding the change and control in behavior due to the techniques used for it:

1. Self-Concept Questionnaire by R. K. Saraswat (1992) has been used to measure self- concept among the adolescents.
2. Indian adaptation of P-F Study by Pareek, Devi and Rosenzweig (1968) was the test to measure aggressive reactions to Frustration.

3. Interview: An interview was conducted to reveal Tolerance, Ahimsa, Truthfulness, Faith and Fidelity.
4. Behavior Scale.

### ***Technique for change in Behavior:***

In order to find out the effect of intervention for the change in behavior, we had applied Yoga as a technique. Yoga was preferred because of its simplicity, our training and its application on a large group at a time.

*In this research we tested Yoga to see its effect on change in behavior of a sample of 150 adults taken from the main sample ranging in age from 30 to 65 years.*

### ***Impact of Yoga:***

Yoga: is a process of self healing and self realization. It is a basic technique for the emotional, physical, mental, behavioral, social, and spiritual development in children and adults. Yoga increases concentration, makes people healthy, increases height, gives strength to muscles and bones and makes all the internal and external organs function correctly. We do not fully know our bodily operating systems but with Yoga our operating systems and whole mechanism becomes correct, and our physical, mental, intellectual and spiritual functions reaches to their heights. We have all the salts, minerals, hormones and energy inside us. Yoga assumes that the whole universe is inside us and it helps us to generate balanced secretion of hormones and energy required for the body. It helps in balancing anabolism, catabolism and metabolism and also *vata, pitta and cough*, which are responsible for our behavior. Thus, if one practices Yoga there will be a change and control in the quality and quantity of food and thought process which eventually starts the process of change in behavior and that too in balanced form.

Practice of Yoga drives a person from demon through humanity and divinity to almighty. Yoga gives us enormous strength to move and move until we achieve our goals.

All the subjects were tested / interviewed to reveal self- concept, aggression, tolerance, truthfulness, faith and fidelity. The subjects were divided in two groups (each of 75 subjects) matched on the scores of the assessed variables. One group named as experimental was given Yogic practice for 15 days daily in the morning from 5:30 to 7:00 am. The Yogic practice included:

*A combination of Asanas (postures), exercises and Pranayama (breathing exercises) were applied to the subjects. It was a package of 60 activities developed on the basis of the methods described by Swami Ramdeo(2009), Swami Satyanand Saraswati(2003), and Shankar(2002), which gives complete exercise to our whole body: external as well as internal organs. The Package included:*

- 1. Chanting of 'OM' followed by 3-4 verses in Sanskrit.**

- 2. Pranayama (breathing) exercises ( 8+1Agnisar Kriya).**Pranayam increases oxygen intake 10 to 20 times than normal breathing. *Pranayama is a practice and medium of meditation. It provides spiritual, divine, cosmic and pranic energy. The pranayama practiced in this research were:*

- **Bhastrika** (Deep diaphragmatic breathing): It increases the oxygen intake in all the cells in our body. It gives strength to lungs, heart and brain. It decreases the toxins in the body. It is good for managing thyroid and tonsils. It can be practiced continuously for 5 to 10 minutes.
- **Kapalabhati** (Exhaling ones in a second but inhaling automatically): Its practice generates an Aura (Abha Mandal/ brightness) around our face and increases its beauty. It is good for strengthening and exercising internal organs of the body, such as; lungs, heart, liver, intestine, kidney, pancreas, thyroid and prostate glands. Its practice jettison away negativity from our body and mind stimulates internal energy and produce internal illumination. It stabilizes our mental processes, gives a feeling of quietness and happiness. **Kapalabhati** is best for the treatment of depression, gastro, sinus and allergy. It can be practiced up to 15 minutes continuously initially starting from 5 minutes.
- **Bahya Pranayama with tribandh:** Exhaling and holding the breath out with Mool Bandh, Uddiyan Bandh and Jalandhar Bandh. When you feel breathing, leave the Bandhs and slowly inhale. It is good for fighting constipation, stimulating hunger and controlling premature ejaculation. It can be practiced for 3 to 5 times.
- **Agnisar Kriya (act):** Exhale completely hold it and move your stomach inside and outside till you feel to inhale. Agnisar is an act good for stomach problems. It can be done once with 5 to 21 ins and outs.
- **Ujjai:** Breathing with throat tightened. **Ujjai** is good in controlling thyroid, snoring and sleep apnoea. It can be practiced for 3 to 11 times depending on your requirement.
- **Anulom-Vilom (alternate nostril breathing):** Start breathing with left nostril by closing right nostril with thumb of right hand then close left nostril with index and middle finger open right nostril and exhale. Inhale in same position with right nostril and close it with thumb, open left nostril and exhale. This is one complete alternate breathing which takes 10 seconds. This Pranayama cleans our nerves and gives strength to our whole body. Its practice relieves from arthritis, gout, blockage in heart, managing cholesterol and triglycerides and mental problems. It regulates the flow of oxygen in our right and left hemispheres and increases concentration. It makes you more positive, Joyce, courageous, enthusiastic, creative and fearless. It can be continuously practiced for 5 to 15 minutes.
- **Bhramari:** Take a deep inhalation, put your both the index fingers on forehead, close both the ears with thumbs, put other 3 fingers on your eyes and bottom of nostrils and breath out slowly with sound of a large black bee (*bhramar*). This pranayama helps in fighting stress throughout the day, increases concentration and gives immense peace of mind. It can be repeated for 5 to 11 times.
- **Udgeeth:** Sit in comfortable posture, Make a circle of your index finger and thumb of your hands, Put your hands on your knees, Close your eyes, Take a deep breath and breath out sounding OM with full faith in Almighty God with determination. It can be repeated for 5 to



11 times. It is good for fighting stress and gives immense peace of mind.

- **Pranav:** Concentrate on your breath with deep inhalation and exhalation for 2 minutes at the end of the practice of Pranayama.

**3. In between the breathing exercises 12 poses of light (Sukshma) exercises were performed.**

**4. Surya Namaskar (12 poses)**

**5. Asanas (12 in number)** There are as many poses as there are species, but we have used only 12 poses, viz.,

- *Briksha(tree) Asana*
- *Trikon Asana*
- *Bhujang (snake)Asana,*
- *Shalabh Asana,*
- *Uttanpada Asana*
- *Nauka (boat)Asana*
- *Markat (monkey)Asana,*
- *Padvrita Asana*
- *Kati-uttan Asana*
- *Pawanmukt Asana*
- *Dvichakrika (cycling) Asana, and finally*
- *Shavasana: mentally watching and relaxing each part of the body with determination.*

If Yogasanas are practiced slowly it gives an extra benefit of increasing concentration along with shaping the body.

**6. Yogic Jogging (12 poses)**

**7. Singh Asana (Roaring like Lion)**

**8. Hasyasana (Laughter, the Attahas)**

Thus, there were 60 actions to be performed in one and half hours with prayers in between. On 15<sup>th</sup> day the subjects were tested on the same variables on which they were tested at the start of the programme.

### **Results and Interpretation:**

The pre and post yogic practice session scores on SCQ of Experimental and Control groups have been presented in tables 2 and 3 respectively. The inspection of tables 2 and 3 reveal that on all the six dimensions of self-concept there has been significant improvement among the group who practiced yoga for 15 days but there has been no significant change in the mean scores of the group who did not practice yoga. Thus, it may be inferred that the practice of yoga for 15 days may help the adults to develop better self-concept.

**Table 2:** Effect of Yogic practice on self- concept (Experimental group)

Dimensions of Self-concept	Pre yoga		Post yoga On 15 <sup>th</sup> day		t-value
	M	S.D.	M	S.D.	
Physical	29.00	3.89	35.67	3.17	5.66**
Social	27.92	2.93	30.25	3.05	2.77*
Temperamental	30.05	3.60	36.18	3.25	6.32**
Educational	30.89	3.84	36.81	3.11	6.04**
Moral	28.70	3.15	35.06	2.97	7.39**
Intellectual	27.78	3.56	34.69	3.16	7.27**

\*\* p < .01, \*p < .05

**Table 3:** M and S D on self-concept of control group

Dimensions of Self-concept	First Test		Repeat on 15 <sup>th</sup> Day		t-value
	M	S.D.	M	S.D.	
Physical	29.27	4.05	29.45	3.87	0.161
Social	28.25	3.17	28.25	3.25	0.000
Temperamental	31.00	3.78	31.16	3.61	0.154
Educational	30.56	3.89	30.60	3.78	0.037
Moral	29.11	3.46	29.27	3.35	0.167
Intellectual	28.08	3.09	28.05	3.01	0.035

All the t- values are not significant

The above findings cannot be compared with other researches in the field because no research is available showing the effect of yoga practices on self - concept. The M, SD and t value on aggressive reactions to frustration assessed by Pareek, Devi and Rosenzweig (1968) P-F study showing the effect of yogic practices has been presented in Tables 4 and 5.

**Table 4:** M, SD and t values for aggressive reactions to frustration among the practicing yoga group

Reactions to frustration	Before Practice of Yoga		After practice of Yoga		t-value
	M	S.D.	M	S.D.	
OD	4.05	1.98	4.56	1.74	2.40*
ED	13.61	2.41	12.52	2.70	3.73**
NP	5.82	2.55	7.44	2.67	5.44**
EA	12.13	4.00	11.10	3.27	2.46*
IA	6.16	2.33	7.13	2.12	3.80**
MA	5.71	2.63	5.77	2.13	0.22

\*\* p < .01, \*p < .05

OD: Obstacle-Dominance, ED: Ego Defence, NP: Need Persistence,

EA: Extragression, IA: Introgression, MA: Imgression.

It can be seen from tables 4 and 5 that there was significant changes in aggressive reactions to frustration in experimental group who practiced yoga for 15 days but there was no significant change in the control group not receiving yoga practice. After practice of yoga the adults scored significantly high on OD, NP and IA but low on ED and EA. Therefore, it may be inferred that the yogic practice has significantly changed the reaction pattern of adolescents, they have a mature and realistic tendency in reacting to frustrating situations as their responses are over whelmed by the barrier occasioning frustration (OD), solution of frustrating problems (NP) and taking self responsibility (IA) but lesser importance has been given to ego defensiveness (ED) and relegating all the responsibility and aggression to the environment (EA). Evasion of frustrating situation (MA) remains unchanged.

**Table 5:** M, SD and t values for aggressive reactions to Frustration among the group of subjects who are not practicing yoga.

Reactions to frustration	At the start of programme		On 15th day without yoga		t-value
	M	S.D.	M	S.D.	
OD	4.28	1.52	4.57	1.77	1.53
ED	13.05	2.45	13.27	3.13	0.68
NP	6.68	2.45	6.11	2.81	1.88
EA	12.41	3.07	12.25	4.21	0.38
IA	6.40	1.98	6.22	2.47	0.70
MA	5.19	1.83	5.11	2.55	1.29

All the t- values are not significant.

*The interview has resulted in information about tolerance, ahimsa, truthfulness, faith and fidelity. Questions were asked e.g. How you will react if a student of your class slaps you on your cheek? If you get a bag full of money what you will do? Who has made this world? etc. The responses were content analyzed. It was found that all these variables remained unchanged in control group but Experimental group who practiced yoga there were an increase in tolerance, truthfulness and fidelity.*

The results of this study cannot be generalized because it was conducted on a small sample but it gives an indication that yoga can be an effective technique for the change in behavior. It is required that the research be conducted on a large sample to find out effect of yoga practice on many more variables such as patience, competitiveness etc.

### **Interpretation of Results:**

The analysed contents were interpreted to formulate the theory and preparation of its first draft. It has been revealed that Yoga is the most important factor for the change, control and development of appropriate behaviour and the **Executive Engine** for the change in behaviors is:

- *Vivacity*
- *Attitude*
- *Discipline*
- *Determination*
- *Trust and*

➤ *Unconditional surrender to Almighty(especially in Yoga)*

If a person has lively spirit, positive attitude, self disciplined approach and determination towards change in his/her behavior, and if he has trust and unconditional surrender to **God** it becomes easy to execute change in behavior in desired direction.

### **The theory**

We were wondering for the last 10 years about three basic questions regarding behavior of people, viz.; what, how and why of behavior? In what way a person behaves? How he or she behaves? And why she or he behaves? Is behavior culturally determined? Do all people across the globe behave in similar manner? How the behavior can be predicted? How it can be controlled? How an unwanted and undesirable behavior can be modified? What are the similarities (dissimilarities) in behavior patterns of the individuals in different countries across the globe? etc. were a few important questions inciting our mind to answer? To describe, control and explain phenomena a well organized experimental observation leading to the development of a theory is required. We were trying in this direction for the last 10 years but without international experiential data it was not possible. Now since we can visit many countries in the world during the past 02 years, we are in a position to present the first draft of the theory:

#### ***Defining Behavior:***

Behavior includes an individual's actions, reactions, activities, responses, movements, processes etc; that is, any measurable response of an individual to a stimulus or to a mental process. Each individual has its unique behavior pattern behaving differently in different situation.

#### ***Main Features of the theory of Behavior:***

The scientific method does not seem to cover the question of where theories do come from. A wide spread answer to this question is ***bed, bath and bicycle***, meaning that theories or good ideas can arise all of a sudden not connected to work. But also highly intuitive processes such as brain storming, day-dreaming or mental imagination have been the basis for theories. On a more systematic level, one can perform guided observations, look over theories and data which are already there or conduct pilot studies after having a first idea, often using qualitative methods(Sedlmeier,2004).Finally, theories are often connected to metaphors such as the stream engine(Sigmund Freud's model of the id, ego, and superego),the computer(many models in cognitive psychology)or the methods themselves(theories modelled after statistical procedures,(cf.Gigerenzer,1991).Basically there is no single systematic method to arrive at good theories because there is no deductive way to do that, and there is nothing to say against theories who have been ***revealed*** to somebody as it is claimed to be true for the meta theory of Indian Psychology.

**It is thus; seems to start with a full-fledged theory that covers a substantial amount of human behavior including all kinds of cognitions and emotions in considerable depth.**

The theory provides an account of the factors that shape the behavior of an individual. It deals with the method of measurement, control and prediction of the behavior. This theory may also be called as ***The Stage Theory of Behavior***.



## **Components of the Theory of Behavior:**

- ***Stages of development of Behavior***
- ***Determinants of Behavior***
- ***Measurement of Behavior***
- ***Prediction of Behavior***
- ***Control of Behavior***
- ***Change in Behavior***

### ***Stages of the Development of Behavior:***

The theory put forth many psycho-socio-cultural determinants of behavior. Genetic factors are crucial in building base for the behavior to grow in cultivating milieu of psychological, cultural and social factors. Development of Behavior takes place in the following stages:

**Stage I:** Childhood is most important stage (0 to 5 years) in which culture and tradition of the family (*Sanskara* and *sanskriti* coming to the child in the form of child rearing practices in particular culture) give thrust for the development of a unique behavior pattern of the child. Love, affection, caring are some factors important for the development of behaviour in a child. Though family, culture and society have influence on behavior throughout one's life span but during the childhood their impact are most prominent.

**Stage II:** In this stage (6 to 12 years) besides food and water, safety, health, clothing, and education, are the prominent factors determining the behavior.

**Stage III:** The III stage spreading through age 13 to 18, sex, power, love, prestige, safety and education are the dominant determinants of the behavior.

**Stage IV:** During this stage (19 to 50 years) again love and sex along with money, power, caste, religion, prestige, quality of food intake, thought process, the organization in which a person works, proverbs, sayings in the society, literature (like *Shrimadbhagawatgeeta*, *Shri Ramcharitmanas*) and place of residence are the directing force for the development of behavior.

**Stage V:** Religious beliefs and practices and life time experiences are dominant determinants of behavior during this stage spreading from above 50 years till the end of life.

### **Strengthening of Behavior:**

Any behavior, adequate or inadequate, desirable or undesirable is facilitated and strengthened by reinforcement. Most of the unwanted behavior is learnt by the individual. The strengthening of any behavior can be explained in the light of a model developed by us and known as Faulty Reinforcement System (Dubey, 1992).

### **Determinants of Behavior:**

- Sex, Anger, Greed (*Lobha*), Passion (*Moha*), and arrogance (*Ahankar*) are the five most dominant driving forces for the development, recurrence, and persistence of any behavior.
- Love, Affection, Compassion, Jealousy, Hatred, Fear and Hunger are the next strongest directing forces of any behaviour.

Sex is one of the pioneer forces in determining behavior. Every person in the world has sexual feelings but every one's experience of sexuality is unique because it is processed through an intensely personal perspective, attitude and belief which come from both private, personal experience and public socio-cultural sources. Masters, Johnson and Kolodny(2001) reported that sexuality has fascinated people from all walks of life from ancient times until the present. Sexual themes have been common in art literature and sculptures especially in India, e.g. Khajuraho temples. Religious Philosophies and legal systems concerned with shaping human behavior tried to establish relationships with sexual values, sexual taboos, and sexual practices in the society and culture. At various times in history, illness, creativity, aggression, emotional disorders and rise and fall of cultures and kingdom has been explained as the result of sexual activity or unusual sexual practices or thought.

- Money, Power (People ignore one if he or she is out of power, even a weakest person does it) and Status are next to them (these are external forces).
- The Outfit (clothing), Physical appearance and colour of the skin are the next important factors which determine the behavior towards a person in any situation.

Individual's behavior rapidly changes according to the status of the person with whom she or he is interacting. The outfit (clothing), Physical appearance and colour of the skin is the most important factors which influence the behavior towards that person in any situation. The dress, colour of the dress, its cleanliness determines the behavior of the person. If a person is clean and has fair skin colour people give respect to him/her.

People **ignore** a person who is close to them as compared to those who are against or whom they want to bring closer. This behavior is very much evident in political circles. e.g. many political parties in India try to favour Muslims and Dalits for votes and ignore their own vote banks of Hindu and upper caste people. In effect they lose their own and do not get support and vote of others. This behavior is evident in daily life conditions as well.

- The behavior is culture specific; it is shaped in the cultural environment of the child through adolescence to adulthood. For example: People in developing countries speak unnecessary and unwanted lie which is transmitted from generation to generation and if a truth is spoken by any person others take it as a lie.
- Behavior in some countries is determined by the caste of an individual. An individual's behavior can easily be understood if one knows his/her caste.

Behavior of a *Kshatriya*(a caste in India) person will reflect bravery; a *Brahmin* is polite and assertive while a *Shudra* is meek but non- conforming and now a days are more violent.

- Religious practice in the family is an important determinant of behavior of a person. Hindus and its allied religions believe that the whole world is like a family( *Vasudhaiav Kutumbakam*) irrespective of the caste, creed, religion, nation and race one belongs to. They are tolerant and respect all the religions of the world but there are religions who preaches arrogance towards other religions of the world. It is the main determinant of conflict worldwide.
- Leadership of the country shapes the behavior of the people in that country. If the leadership is patriotic, honest and caring for countrymen the people of the country are most likely to develop similar behavior pattern.

- Behavior is determined by the quality of food intake by the individual. The behavior of vegetarian people is different from those whose food intake is non-vegetarian.
- People in developing countries lack in basic scientific temper required for the development of appropriate behavior. They generally take the stimuli according to their own attitudes, values, personality, need patterns etc.

If they go through the scientific process of collecting information such as observation of stimuli in natural condition without imposing their own attitudes etc. the behavior is more likely to be appropriate. These inappropriate behaviors are strengthened by unscientific testing of hypotheses generated out of inappropriate behavior pattern. This is also root cause of behavioral problems manifesting into behavioral and psychological disorders.

- Children's behavior is imitative; they behave as their elders are behaving, they do whatever their elders are doing. The language spoken by a child as mother tongue is most prominent example of behaving by imitation by a child. Similarly, elder people imitate others behavior in a society and in a culture.
- Girls across the globe are basically shy with little deviations, in developed countries they are less shy as compared to developing eastern traditional and Muslim countries, such as; India, and Middle East.
- Adolescents are generally arrogant, they are rebellious in family but in most cases loyal to friends.
- If some facilities and comforts are provided and some advantages are given to a not deserving person by an organization or by another person, he takes it as his right and if those facilities and advantages are withdrawn at a later stage, he will feel uncomfortable, become angry and violent towards those who had provided the facilities, comforts and advantages.
- Individuals generally, and mostly in poor countries do not understand that which behavior is appropriate?

In most of the cases inappropriate behavior patterns are taken as appropriate ones.eg. Purchasing many articles made in developed countries which are really not so good but costlier than what is available and made in their own countries has become a craze. This is an inappropriate behavior but people's behavior is determined by this type of factors which may be called as greed for foreign articles.

- People in poor countries do not act judiciously. Their behavior is guided by instincts which are dominated by *Id* in Freudian terminology. This is common in African countries.
- If an individual gives respect and importance to an undeserving person, she/he thinks that individual who is giving him importance is inferior, meek and submissive and in turn, she/he tries to avoid and ignore that individual and does not give desired attention.

So, it is better to be little aggressive in interpersonal relations and try to be assertive with little dominance. Giving importance is a powerful factor that determines the behavior.

- If a person is in trouble and he/she is confronting a powerful person, the behavior of others towards him/her change drastically. Only a few close ones give positive suggestions and show way out and that too in absence of others so that the powerful person must not know. Others try to stimulate in such a way that he/she is put in still more trouble. Such people will come to the person in trouble and suggest that do not **do this and that, where as those this and that are the way out** to resolve the problem and get rid of the trouble. They will also make mountain of mole.
- Hypocrisy is a prominent feature and directing force of behavior pattern of the people in developing countries and it filters down to common people from those who govern the country.

The people in high rank have double standard; they promise something but act differently. They have different ideas than what they talk and their action is still different. A person always thinks that others are not correct for any behavior but he himself thinks to be correct for the same type of behavior. e.g. one individual teacher in Addis Ababa University has told me that he has a very good friend in Indian Embassy in Addis Ababa who told him that highly educated Indian teachers use to come daily to meet people there. The teacher commented that it is not fair for highly educated teachers to go to Embassy to meet less educated people working there. But for himself, his behavior of having close friends in Embassy whom he calls of lower educational qualification is correct. People have this type of double standard in their thinking.

- Information furnished by many people may be incorrect but persons receiving this information take as truth without checking the validity of the information.

For Example: If a person says that a particular place is very clean others will accept without applying their intelligence and without observing. Similarly if few people call a person very good others who have no any interaction with that person will take it as granted. This is as if you speak a lie 100 times it will become a truth. This is **Hallow effect** which determines the behavior.

- If a person does not know another his/her behavior is not inhibited but if he/she knows to some extent his/her behavior is inhibited towards that person. Further, if the person is of opposite sex inhibited behavior is more likely to occur.
- People, if they have very strong positive or negative attitude towards a person, group or society as a whole, they behave accordingly. In such condition, they generally do not receive, perceive and analyze the stimuli correctly and react accordingly. This is generally inappropriate reaction and response to the stimuli.
- Behavior is governed by Sadism. If one finds you in trouble she/ he pretended to be sad and unhappy of your situation but she/ he is internally delighted.

A Couplet by poet Rahim says that if you share and discuss your problems and troubles people will laugh rather than help you to resolve your problems and troubles. Keeping this in mind people does not discuss clearly their problems with others.

- A person in trouble is left alone by all his/her friends, relatives and many times by his/her spouse.
- If a person has done any harm to you (s)he will avoid eye contact irrespective of your knowing that what harm has been done.

- People if forced to face a common problem behave entirely in a different manner, different from their original behavior pattern, but as soon as they are in their original surroundings they come to their usual behavior pattern.

For example; during tsunami in India many people had shown altruistic behavior and were helpful but it was not the original behavior patterns of most of them. Therefore, to understand, control, and predict any behavior it is **apparent that the behavior be observed in original settings of the person.**

- People are generally selfish. They like only those who agree with them. In case of disagreement disliking develops.
- Unnecessary lying has become the behavior pattern of the Indians. If you ask a person coming out of his home that from where is he coming? He will lie, and surprisingly his response may be that he is coming from market.
- Indians are basically submissive but they show aggression towards weak persons and towards them who cannot harm them but if they face a strong person they become utmost cowardice and show extreme submissive behavior.
- Beggars' behavior is culture free and similar across the globe. They sit around religious places and beg to any person going through their way around. Most of the time they forcefully ask for money irrespective of the limitation of the person to whom they are asking.

***Thus, we come to the conclusion that the most important determining factors of any behavior are:***

- ***Sex***
- ***Anger***
- ***Greed***
- ***Ignorance***
- ***Arrogance***
- ***Hunger***
- ***Love***
- ***Affection***
- ***Compassion***
- ***Jealousy***
- ***Money***
- ***Status***
- ***Power***
- ***Family Variables such as;, Culture, Caste and Religious practices***



- ***Behavior of Leaders in the organization***
- ***Behavior of Political and Religious Leaders***

#### **Measurement of behavior:**

Measurement of the behavior can be done by the **Behavior Scale** developed by the author and some other valid psychological tests.

#### **Prediction of Behavior:**

Behavior can be predicted by investigating and understanding the determinants that initiate and strengthen the behavior.

To understand, control, and predict any behavior it is important that the behavior be observed in original settings of the person. Before we predict any behavior one has to keep in mind the following factors:

- Cultural, social, caste and religious background of the person.
- Ethnicity and country to which one belongs.
- Behavior of Governing Political leaders of the country.
- All other determinants of behavior described in preceding section.

#### **Control and Change in Behavior:**

Control in behavior and desired change can be achieved at 3 levels: (1) Stimulus –response level; by the process of reinforcement. (2) Cognitive level; through cognitive behavior therapy. and (3) Internal level; through **Yoga**. There are **four** factors that prepare the **base** for the change and control in behavior:

- Enthusiasm, vivacity, trust and encouragement to change one's behavior.
- Understanding one's strengths and weaknesses.
- Leaving behind one's greed and arrogance.
- Developing Truthfulness, Tolerance, Compassion and Non –violence.

The last factor is the most prominent for the change in any behavior. It affects at internal and implicit level and can be achieved easily through **Yoga Science**. **Yoga is a complete, scientific, harmless, energetic and effective exercise for the control and change in behavior**. For a common person Yoga is simply the practice of Asana. But it is only the third component of Astang yoga as **Yoga** has eight components viz; Yama, Niyama, Asana, Pranayama, Pratyahar, Dharana, Dhyan and Samadhi. With practice of a package of Yoga described earlier under section **Executive Technique for change in behavior** can be achieved provided the person has prepared himself according to above 4 factors.

**Change in behavior would lead to a world free from drug, disease, violence and corruption.**

#### **References**

Bunge,M. and Ardila,R.(1990). *Philosophy of Psychology*.Tubingen:Mohr

- Baron, R.A. and Kalsher, M.J. (2013). *Psychology*. New Delhi: Pearson
- Clare, S. (2003). *Trust your Intuition*. Delhi : McMillan.
- Day, L. (1996). *Practical Intuition*. New York : Broadway Books.
- Denning, H.M. (2001). *Intuition and Synchronicity*. Virginia : A.R.E., Press.
- Dubey, S.N. (1992). *Faulty Reinforcement System*. CPAI Newsletter, Volume 02, Issue 01.
- Dueby, S.N. (2004). Yogic Life styles of Indians. Paper Presented during the *International conference on Indian Psychology, Yoga and consciousness*, Pondicherry, December 10 to 13.
- Ewen, R.B. (1980). *An Introduction to theories of Personality*. New York : Academic Press.
- Fitz, H.K. (2001). *Intuition : Its Nature and Issues in Human Experience*. New Delhi : Motilal Banarasidas.
- Gigerenzer, G. (1991). From tool to theories: A heuristic of discovery in cognitive Psychology. *Psychological Review*, 98, 254-267.
- Goswami Tulasidas (2013). *Shri Ramcharitmanas (in Hindi)*. Gorakhpur: Geeta Press.
- Goyanaka, Jaidayal (2013). *Shrimadbhagawatgeeta (in Sanskrit with Hindi translation)* Gorakhpur: Geeta Press.
- Graham, C.H. (1950). Behavior, perception and the Psychophysical Methods. In J.P. Guilford, J.P. (1978). *Psychometric Methods*. Delhi : Tata Mc Graw-Hill.
- Masters, W.H; Johnson, V.E. and Kolodny, R.C. (2001). *Masters and Johnson on Sex And Human Loving*. Mumbai: Jaico Publishing House.
- Mc. Dermott, R.A. (1970). *Basic writings of S. Radhakrishna*, Bombay : Jaico Publishing House.
- Myers, D.G. (1986). *Psychology*. New York : Worth Publishers.
- Pandey, Y.N. (2007). *Kavyanjali (Edited in Hindi)*. Allahabad: Rajeev Prakashan.
- Pandey, Y.N. (2007). *Kavya Sankalan (Edited in Hindi)*. Allahabad: Rajeev Prakashan.
- Pareek, U. Devi, R.S. and Rosenzweig, S. (1968). *Manual of Indian Adaptation of the Rosenzweig P-F study*. Varanasi: Rupa psychological corporation.
- Saraswat, R.K. (1992). *Manual for self-concept Questionnaire*. Agra: National psychological corporation.
- Sedlmeier, P. (2004). Western scientific methods and Indian Psychology. Paper presented during *International conference on Indian Psychology, Yoga and consciousness* Pondicherry, December 10 to 13.
- Shankar, G. (2002). *Yogic and Nature Cure Treatment for Common Ailment*. New Delhi: Central Council for Research in Yoga and Naturopathy.

Sharan, M.B. (2004). Understanding human mind and Behavior : The missing link of Intuitive experience. paper presented during *International conference on Indian Psychology, Yoga and consciousness*. Pondicherry, December 10 to 13.

Swami Ramdeo (2009). *Pranayama Rahasya(in Hindi)*.Haridwar:Divya Prakashan.

Swami Satyanand Saraswati (2003). *Surya Namaskara: A Technique of Solar Vitalization*.Munger:Bihar School of Yoga.

Triandis, H.C. (1977). *Interpersonal Behavior*. Monterey CA. : Brooke-Cole.

The logo for the International Association for Frontiers of Research (iafor) is centered on the page. It features the lowercase letters 'iafor' in a light blue, serif font. The text is enclosed within a circular frame composed of two overlapping, hand-drawn style arcs. The upper arc is a light red color, and the lower arc is a light blue color, matching the text color. The overall design is minimalist and artistic.

*Consumer Market for Functional Foods in Thailand*

Phanchita Methakornkulnan\*<sup>1</sup>, Ying-Jiun Hsieh\*<sup>1</sup>, Lan-Ying Huang\*<sup>2</sup>

\*<sup>1</sup>National Chung Hsing University, Taiwan, National Changhua University of  
Education, Taiwan

0146

The Asian Conference on Psychology & the Behavioral Sciences 2013

Official Conference Proceedings 2013

Abstract

Functional food is any healthy food claimed to have a health-promoting property beyond the basic function of supplying nutrients. The awareness in developing functional foods is thriving, driven largely by the market potential for foods that can improve the health and well-being of consumers. However, functional food is starting consumer attraction in Thailand. The purposes of this study are (1) to explore the currently existing functional food products in the local retail market in order to improve understanding of consumers' market supply and (2) to determine consumers' motivation, attitudes towards functional foods which open a market opportunity for functional food in Thailand. This study surveys were showed from 650 consumers who live in Bangkok. The results of this investigation displayed that the functional food market is growing in Thailand. The current local functional food products in the market were highly competitive with consumers' approaches. It showed good agreement with the survey result, and represented there is two types of consumers. First type, who is not interested in health benefit from functional food, is called "Ordinary". The second type is "Healthlism" that consume functional food products regularly. However, both types of consumers are confident with the information about the benefit of this product from Scientists/Researchers, scientific research reports and Food industry. Consequently, based on this study, Thailand companies and the food industry could develop their market strategy to compete in the functional food market.

Keywords: Functional food, Attitudes, Factor analysis

## 1. INTRODUCTION

The food industry is directing new product development towards the area of functional foods and functional food ingredients due to consumers' demand for healthier foods. The functional foods interest is increasing throughout the world market; also functional foods have been expanding and are driven by economic and social trends (LFI, 2006). In Thailand, as in many Asian countries, has promoted an industry, export-oriented food products and thus leading to improved productivity (UNDP, 2011). However, one of the most significant discussions in the field of functional foods market is consumers' attitude, due to the lack of understanding about functional food (Childs and Poryzees, 1998).

Each country has different type of consumers and different credibility to trust on information source. Recently, a considerable amount of literature has been published on consumers' motivation, attitudes towards willing to buy functional foods. Finnish consumer and South Brazil have positive attitudes towards functional foods and enough purchasing power (Barcellos & Lionello, 2011; Urala & Lahteenmaki, 2004). Since, Bhaskaran & Hardley (2002) indicated quality, price/value, convenience and health effect of functional foods are the key factors in purchase intention. Correspondingly, the full market potential for functional foods can only be maximized with the development of market-oriented products that gain consumer acceptance (Bogue et al., 1999). In addition, lifestyle is a social factor based on the basic needs of humans that is strongly affected by their simultaneous needs for integration (belonging to a group) and differentiation (individuality) (Szakaly et al., 2011). Accordingly, demographic, economic, social and cultural changes in consumer lifestyles continue to have a significant impact on attitudes towards food products and subsequent consumer demand (Reuters Business Insight, 2000), for example, the literature shows that Male consumers are less promising target group for functional foods than female (Urala, 2004). However, strategies for functional foods industries were developed from these predictions. The future market development is influenced by degree of familiarity and acceptance of functional food as well (Menrad, 2003).

The goal of the present study was to understand the consumers' aspect with local food companies' market supply in Thailand. Accordingly, through the market observation techniques which help to understand consumer's need, attitudes and perceptions more completely. Secondly, we evaluated the consumers' motivation, attitudes and intention to buy functional foods in Thailand. Those out comes could help major implications for food company and economic progress.

### **Functional Food**

The growing awareness of the healthy lifestyle has led to an increasing demand for food products that not only provide beyond basic nutrition but support health above.



Health conscious consumers are increasingly seeking functional foods information in effort to confirm the health safety of functional food products. Although the definition of functional food has not universally accepted (Roberfroid, 2002), so far Siro (2008) pointed out that “ In most countries there is no legislative definition of the term and drawing a border line between conventional and functional foods is challenging even for nutrition and food experts. However, some countries have their own health claims regularly in order to protect consumers from false and misleading claims, for example, Japan has FOSHU (Foods for Specified Health Use), Australia and New Zealand has FSANX (Food Standards Australia New Zealand), US has FDA (US Food and Drug Administration), and Europe has FUFOSE (Functional Food Science) (EUFIC, 2006).

One definition of functional foods that the EC concerted Action on Functional food Science in Europe (FUFOSE) have proposed “A food that beneficially affects one or more target functions in the body beyond adequate nutritional effects in a way that is relevant to either and improved state of health and well-being and/or reduction of risk of disease. It is consumed as part of a normal food pattern. It is not a pill, a capsule or any form of dietary supplement” (FUFOSE, 2010). Moreover, Kotilainen and Spence (2006) have divided four types of functional foods categories. First type, Fortified products definition is a food fortified with additional nutrient. Second type, Enriched products definition is a food with added new nutrients or components not normally found in a particular food. Third type, Altered products definition is A food from which a deleterious component has been removed, reduced or replaced with another substance with beneficial effects. Last type, Enhanced commodities definition is a food in which one of the components has been naturally enhanced through special growing conditions, new feed composition, genetic manipulation, or otherwise. However, this is just one of the possible classifications.

## **2. RESEARCH METHOD**

The purposes of this study are characterize the currently existing functional food products in the local retail market and identify consumers' motivation, attitudes towards functional foods. Sequentially, we used two stages to research consumer market for functional foods in Thailand. First, we used market observation techniques which identified available functional foods products at local retail level. We have visited four retail stores (Big C, 7-11, Tops, Tesco-lotus) and categorized the type of functional product, main benefit offer to customer, the brand and status of the food processing industry. Second, the questionnaire used during the survey in order to identify the character and frequency of consumer consumption. The questionnaire performance was pre-test in English, and then translated into Thai version. The survey was conducted in Bangkok, capital of Thailand. Bangkok was selected to ensure that range of consumer types are included in the study.

## **2.1 Data collection**

The data was collected in July and August 2012. Four supermarket and stores in Bangkok were selected for the interviews. Examples of functional foods were prepared and showed during interviews in order to make sure that respondents are understand the same point. Although there is no way of knowing if those included are representative of the overall population, the survey is still expected to give a first overview of relevant issues and to allow to derive insights into the attitude of functional foods by consumers in Bangkok.

The questionnaire preparations methods were adopted from Barcellos and Lionello (2011). The questionnaire was divided into three parts. The first part containing, socio-demographic questions and frequency of consumption of functional foods about the respondents were asked. In the second part of the questionnaire, question investigated the attitudes towards functional foods were assessed. In the last part of the questionnaire, the set of questions related to motivations to consume and trust in the innovation system agents were collect. The 7-point Likert type scale: 1, strongly disagree and 7, strongly agree was used.

## **2.2 DATA ANALYSIS**

The statistical analysis was performed using a SPSS statistical software package (SPSS Inc., 2003). Exploratory factor analysis (EFA) was performed on the scores for the 24 items of attitude towards functional food questionnaire, to reduce the original items into different factors. A factor loading above 0.4 was significant. A varimax rotation method was performed; the matrix and factor loading and the reliability of scales (Cronbach's alpha measures) are presented. The Kaiser-Meyer-Olkin (KMO) should be 0.5 or grater to measure the sampling adequacy. The Bartlett's test of sphericity is also significant at  $p=0.000$ , indicating that the correlation matrix is not an identity matrix, a positive signal for the analysis.

To form groups of related variable, two-stage of cluster analysis was applied. An agglomerative hierarchical cluster analysis based on scores given to the different attitudes towards functional foods items was carried out to identify segments of consumers (stage1), the k-means procedure implemented on the hierarchical clusters' centroids followed, with the option of identifying 2-5 clusters (stage 2). The cluster membership variable and the socio-demographic, attitude and consumption frequency variables were analyze by Crosstabs. Interpretation of results and conclusions were presented in the result section.

## **3. RESULTS**

### **3.1 Functional Product available at large retail chains in Thailand**

The results of functional product availability at large retail chains in Thailand showed in Table1. According to observation market survey, found that the functional foods

companies mostly attempt to add a benefit and emphasize beauty. Dairy products containing probiotics was expanding in market, it is become a new trend in Thailand. The concentrated extracts, products and drink products were highly promoted to control a beauty balance. It is possible that consumers choose food and drinks which not only give them energy but are also able to be of benefit to beauty body and the digestive system.

Table1: Functional/Enriched/Fortified products available at large retail chains in Thailand

Category/ Food Product	Benefit	Brand/Company (status*)
<b>Dairy Products</b>		
Fermented milk	Gut health –Probiotic (bifidobacteria, Lactobacillus acidophilus ),Omega 3, Vitamin(A,C,D), Mineral	Yakult/Yakult (MN) Dutch Mill (LO) Betagen (LO) Foremost(MN)
Yogurt	Gut health –Probiotic (bifidobacteria, Lactobacillus acidophilus ), Vitamin, Antioxidants, Collagen, Omega 3	Danone Dairy (MN) Dutch Mill (LO) Foremost(MN)
Enriched UHT Milk	Antioxidants ,Bone health (calcium),Vitamin, Iron, Collagen	Nongpho/Nongpho Dairy (LO) Mali/The Thai Dairy (LO) Anlene/Fonterra(MN)
<b>Concentrated Extracts Products</b>		
Essence of Prune	Beauty Balance, VitaminB2 (Riboflavin) (Calcium), Vitamin C (Ascorbic Acid) Antioxidence, Gut health	Brand’sVeta/Cereboss (MN) Scotch Puree/S & Sons (LO) DHC Prunc/DHC (MN) Blink Prune/T.C National (LC)
Essence of Chicken	Protein, Calcium, Iron, Vitamin B	Brand’s/Cereboss(MN) Scotch/S & Sons(LO)
<b>Drink</b>		
Energy drinks	Brain health – mood (taurine, caffeine)	M-150/Osotspa (LO) Ranger/ThaiBev(LO) Peptein/Osotapa (LO) Oishi/Oishi group(LO) Namacha/Kirin (MN)
Beauty drink	Beauty Balance, Vitamin B2 (Riboflavin), Vitamin C (Ascorbic Acid) Antioxidence, Collagen	Dakara/Tipco (LO) Puriku/T.C. Pharmaceutical (LO)

\*status is defined as LO stand for the company's capital is local (Thailand) and MN stand for multinational.

### 3.2 Results from Functional Food Consumer survey in Thailand

#### Demographic profile of the sample

The majority of respondents are female (64.9%) 422 from 650 interviewees. Men's interviewees are minority (228). Ages ranging between 25 and 44 years old were 69.4%, younger than 24 years old were 28.3% and between 45 and 64 years old were 2.2 % of the sample. Only a small number of respondents with above 65 years old have 1 respondent. Respondents with university education represented 61.5% of the sample, followed by secondary completed education represented 18.2%, with post-graduate degree 17.4%. The smallest numbers of respondents were technical education 2.8% of the total.

The response to household situation, most of these surveyed indicated that 64% of the sample live with parents, 20.2% live alone, 7.5% live with friends, 4.8% lives with its spouse/husband, 2.9% live with their spouse and kids. Only 4 respondents live with their son/daughters. Regarding to household incomes, approximately half of these surveyed were 10,001-30,000 Baht. 26.3% of respondents had income lower than 10,000 Baht. Between 30,001- 50,000 Baht and over 50,001 Baht are represented 14.5% and 9.1%. Only one respondent had income over 50,001 Baht.

The frequency of consumption was described in Table 2. The response rate was 41.7% who consume functional food category on weekly basis, while 16.3% consume it daily, indicating that the overall response to this food category represented a positive trend for functional food market.

Table 2: Frequency of consumption of functional food in Thailand

	Frequency	Percent
Daily	106	16.3
Weekly	271	41.7
Fortnightly	65	10.0
Once a month	84	12.9
Rarely	124	19.1
Total	650	100.0

### 3.3 Attitude towards Functional foods

The respondents were responded a positive attitude towards functional food in Thailand. This study produced results that items highly ranked were composed by health, safe and innovation product provided by functional foods. The majority of respondents are women. Noteworthy similarities exist between the attitudes expressed

by the main motivations in this study and those described (Bech-Larsen & Scholderer, 2007; Frewer et al., 2003; Barcellos and Lionello, 2011).

To identify the main dimensions within attitudes towards functional food in Thailand by Exploratory Factor analysis (EFA). The factor loading of Healthy benefit factor was from 0.59 to 0.817, Safety factor was from 0.551 to 0.717, Innovation products factor was from 0.449 to 0.735 and medicine factor was from 0.706 to 0.834. Reliability of the attitudes factor (Cronbach's alpha) were higher than 0.6. Total Variance was Explained 63.43% of the phenomenon. The correlation matrix of factor loadings the Kaiser-Meyer-Olkin (KMO) and Bartlett's test illustrate significant results in 0.953 ( $p = 0.000$ ).

In recent years, the research in attitudes towards functional foods found by Urala and Lahteenmaki in 2004 and 2007, which identified four attitude factors towards functional food in the 2004 study (reward from using functional food – FF Rew, confidence in functional foods – FF Con, necessity for functional foods – FFNec, and functional foods as medicine FF Med) and four factors in 2007 (reward from using functional foods – FF Rew, confidence in functional foods – FF Con, necessity foods – FF Nec and safety of functional foods – FF Saf). Barcellos and Lionello (2011) found three factors such as reward from using functional foods – FF Rew, trust in functional foods – FF Tru and functional foods as medicine FF Med.

Four factors found in our study. The first factor named “healthy benefit” (FF Hea). The main propose of this dimension is using functional foods get benefits and improve welfare. The second factor was termed “safety” (FF Saf). This issue describes what consumers investigate information and trust the safety of functional foods. The third factor was described “innovation product” (FF Inn). It was combination between technology and development product. Customers who rate score high on this scale are welcome to try a new product. The last factor named as “medicine” (FF Mec). It described strongly believe in food that have like medicine effects. The mode of Attitudes towards functional foods would be precious for development functional food market in Thailand.

### **3.4 Cluster analysis**

Cluster analysis was used to analyze the differences, and two clusters were found in the scores, named “Ordinary” and “Healthlism”. The summary of the cluster profiles in terms of Socio-demographic characteristics and consumption frequency and Motivation, attitudes towards functional foods and trust in the agents of the innovation system.



Table 3: Cluster Profiles in terms of socio-demographic characteristic (percentages)

Social-demographic profile		Sig.	Cluster 1 N1=248 38.2%	Cluster 2 N2=402 61.8%	Sample N=650 100%
Frequency of consumption	Weekly	**	35.9	45.3	41.7
Gender	Female	*	59.7	68.2	64.9
Age	25-44	n.s	66.9	70.9	69.4
Household status	Parents	n.s	60.9	65.9	64.0
Education	University	n.s	64.9	59.5	61.5
Income	10,001-30,000	n.s	50.8	49.5	50

Note: Chi-square tests with \*\*:  $p < 0.01$ ; \*:  $p < 0.05$ ; n.s: not significant

As illustrate in table 3, clusters significantly ( $p \leq 0.05$ ) differed in their gender and frequency of consumption. Cluster1 has men respondents' ratio higher than cluster2. Their income and education were higher than the other one. Nevertheless, their frequency of consumption was less than cluster2. The number of females who consume functional food is significantly greater than that of males ( $p < 0.05$ ). However, men are found to be less frequent consumers. Hence, the name of this cluster is "Ordinary". Cluster 2 was composed mainly by women with middle ages. The majority of functional foods were consumed on weekly basis. The segment of consumers seemed to be concerned about wellness and beauty; the name was called "Healthlism".

Table 4: Cluster profiles in terms of motivations to consume, confidence in the FF

Measurement items	Sig.	Cluster 1 N1=248 38.2%	Cluster 2 N2=402 61.8%	Sample N=650 100%
<b>Motivations to consume(Alpha=0.914)</b>				
1.Habit or tradition	**	4.17	5.48	4.98
2.To keep a healthy lifestyle	**	4.09	5.74	5.11
3.To prevent diseases (in the individual or family)	**	3.64	5.38	4.72
4.To control appetite and body weight	**	3.92	5.39	4.83
5.To increase wellness	**	3.98	5.77	5.09
6.To improve physical appearance	**	4.07	5.59	5.01
7.To increase mental and physical performance	**	3.61	5.08	4.52
8.Gut health/flora equilibrium	**	4.12	5.65	5.06
9.To reduce cholesterol/heart diseases	**	3.77	5.36	4.76
<b>Attitude towards Functional Food</b>				
Healthy benefit from using functional foods (Alpha=0.948)	**	4.13	5.37	4.26
Safety of functional foods (Alpha=0.817)	**	3.77	4.76	4.75
Innovation product of functional foods (Alpha=0.736)	**	4.70	5.70	5.21
Functional foods as medicine (Alpha=0.698)	**	3.23	4.28	3.76
<b>Confidence in the FF innovation system agents(Alpha=0.906)</b>				
10.Health professionals	**	3.93	5.63	4.98
11.Dieticians/Nutritionists	**	4.23	5.79	5.20
12.Pharmaceutical/medical industry	**	4.12	5.63	5.05
13.Retailers	**	3.75	5.08	4.57
14.Food industry	**	4.37	5.88	5.30
15.National Health Authorities	**	4.24	5.83	5.22
16.Scientists/Researchers	**	4.46	5.97	5.39
17.Media (Television)	**	4.06	5.34	4.85

Note: Z-tests with \*\*: p<0.05

All items measured on a 7-point scale with end points 1 = “strongly disagree” to 7 “strongly agree”

Cluster profiles in terms of motivation identified that consumer from cluster1 were not consumed functional food because of healthy motivation. While consumers from cluster2 strongly consume functional food regularly in order to increase wellness and to control appetite and body weight. It has related to socio-demographic profile in terms of gender and age. Furthermore, cluster2 is interesting innovation product of functional foods and healthy benefit from using functional foods more than cluster1. Both clusters have confidence in their Scientists/Researchers and Food industry. In

the part of marketing view, whether Food Company launches a new product to market and consumer are willing to try functional foods. This survey would be useful for marketing strategy.

#### 4. CONCLUSIONS

Functional foods market in Thailand is more competitive and become popular in the future trends. Changes in consumer's lifestyles, awareness and interest in their own health and well-being become important factors according to this study. The analysis of market observation showed that functional foods companies are launching developed products that provide specific health benefit beyond basic nutrition. Our survey result shows that consumers in Thailand have highly positive attitudes towards functional foods. Women seem to be more likely to purchase functional foods than men. The survey results also showed that consumers are more aware of healthy benefit from using functional foods, safety of functional foods, innovation products of functional foods and functional foods as medicine. In this study, consumer segments were divided into two groups. First group composed of consumers with high income, education, and men respondents' ratio higher than the other group. While the other group was not only more concerned about wellness and beauty but also strongly consume functional foods regularly. Moreover, scientists/researcher and the food industry have high credibility and could help inform consumers about benefit of functional foods. Such market development follows specific characteristics that begin to cooperate between research and development section and marketing section in order to develop key success factors for the functional foods market. Some limitation of present study should be addressed. Further research should conduct more information about Thailand consumer' perception of functional food and explore how to increase consumers' functional food knowledge in Thailand. Furthermore, design and package of products will be affecting to consumer purchase.

## REFERENCES

- Barcellos, M. & Lionello, R. (2011). Consumer Market for functional foods in South Brazil. *Int. J. Food System Dynamics*, 2(2), 2011, 126-44.
- Bech-larsen, T. & Scholdere, J. (2007). Functional foods in Europe: consumer research, market experiences and regulatory aspects. *Trends in Food Science & Technology*, 18, 231-234.
- Bhaskaran, S. & Hardley, F. (2002). Buyers beliefs, attitudes and behavior: foods with therapeutic claims *Journal of Consumer Marketing*, 19, 591-606.
- Bogue, J. C. & Delahunty, C.M. & Hency, M.K. & Murray J.M. (1999), "Market oriented methodologies to optimize consumer acceptability of cheddar-type cheeses", *British Food Journal*, 101(4), 301-16.
- Childs, N.M. & Poryzees, G.H. (1998), "Food that help disease: consumer attitude and public policy implications", *British Food Journal*, 100(9), 419-26.
- European Food Information Council (2006), "Basic functional foods", available at: [www.eufic.org](http://www.eufic.org) (accessed 8 January 2013).
- Frewer, L. & Scholderer, J. & Lambert, N. (2003). Consumer acceptance of functional food: issue for the future *British food Journal* 10, 714-731.
- FUFOSE: Functional Food Science in Europe. available at: [www.ilsa.org](http://www.ilsa.org)
- Kotilainen, L. & Rajalahti, R. & Ragasa, C. & Pehu, E. (2006). Health enhancing foods: opportunities for strengthening the sector in developing countries. *Agriculture and Rural Development Discussion Paper* 30.
- LFI. (2006). *The International Market for Functional Foods: Moving into the mainstream?* Retrieved May 28, 2007a.
- Menrad, K. (2003). Market and marketing of functional food in Europe. *Journal of Food Engineering* 56, 181-188.
- Reuters Business Insight (2000), "Future innovations in food and drinks", available at: [www.just-food.com](http://www.just-food.com) (accessed 8 January 2013).
- Siro, I. & Kapolna, E. & Kapolna, B. & Lugasi, A. (2008). "Functional food Product development, marketing and consumer acceptance-A review". *Appetite*, 51 (2008), 456-467.
- SPSS Inc. (1993). 444 North Michigan Avenue, Chicago, IL 60611, U.S.A.
- Szakaly, Z. & Szente, V. & Kover, G. & Polereczki, Z., Szigeti, O. (2011). The influence of lifestyle on health behavior and preference for functional foods. *Appetite*, 58 (2012), 406-413.
- UNDP. (2011). *Thailand Human Development Report 2007-Sufficiency Economy and Human Development United Nations Development Programme*, Bangkok.
- Urala, N. & Lahteenmaki, L. (2004). Attitudes behind consumers' willing to use functional foods. *Food Quality and Preference*, 15, 793-803.
- Urala, N. & Lahteenmaki, L. (2007). Consumers changing attitudes towards functional foods. *Food Quality and Preference*, 18, 1-12.

*Can Personality Type be Predicted by Social Media Network Structures?*

Matthew Escobido, Gillian Stevens

Asian Institute of Management, Philippines

0152

The Asian Conference on Psychology & the Behavioral Sciences 2013

Official Conference Proceedings 2013

Abstract

Social media platforms have become an integral part of how we live our lives, in particular for those generations who have grown up in the digital world and use these platforms to connect and communicate with many different groups. Personality profiling now underpins many facets of our lives for example digital marketing campaigns target specific audience groups using information gleaned from how a person engages with social media (Seung, 2012). Specific personal information that could assist with precise targeting might be helpful to those who want to interact with people via digital media. Psychological Type suggests we are predisposed to certain behaviors and preferences (Jung, 1921). Traditional methods of assessing personality include observation or psychometric questionnaires. Both methods have their benefits and drawbacks but what are the alternatives? Can the digital world and in particular, social media platforms, provide an alternative method? If a person's digital personality footprint could be assessed by the way they engage in social media activity this information could be used to precisely target informative communications as well as product marketing campaigns (Maehle & Shneor, 2010).

This paper presents a summary of initial work undertaken to explore the nature of structural patterns represented by an individual's Psychological Type, as defined by their MBTI type and specific aspects of their social network data, as defined within the context of their Facebook connections and usage. Initial findings suggest that the virtual world is able to reflect personality differences that exist in the external world. Ongoing research is being undertaken to build on these initial findings.



## **INTRODUCTION**

The world is shrinking. The concepts of Globalization and ‘Six Degrees of Separation’ mean that relationships between organizations and people are becoming more interconnected. It is now possible through the lens of social media to search for and connect to a person anywhere in the world without any prior physical or social contact. The current, popular social media platforms of Facebook, LinkedIn and Twitter encourage such networking. This means that people now develop relationships and connections with people for no reason, other than to widen their personal and business on-line contacts. Cyber-networking has replaced the need for face-to-face networking when searching for a job; when conducting research and appears to provide more efficient ways to engage in debates that extend existing knowledge and discourse.

Income generation from on-line advertising and sponsorship is now big business. In fact, digital marketing has become a discipline in its own right. Traditional marketing and advertising campaigns are now being substituted by social media campaigns to expand their reach towards targeted audiences (Seung, 2012). If marketers and those interested in disseminating information to specific groups of people could tap into reliable information about a person they could direct their campaigns more precisely (Maehle, Shneur; 2010). Currently marketers rely on information in the digital world that an individual makes known or is willing to reveal in the public domain, for example what products and services they use, like and share within and across their personal social media networks.

If organizations could know more about the personal characteristics of the people that they were aiming to target, the more focused their campaigns could be. However, such information is very personal to an individual and is unlikely to appear openly in the public domain. If information that characterizes personality could be translated into a format that appeared in a de-sensitized and anonymous configuration, it might prove advantageous to a range of end-users. The intention of this research is to find alternative ways of representing such personal information whilst maintaining confidentiality and integrity.

### **Understanding and Assessing Personality**

There are different models that help to explain and understand the concept of personality. Two contrasting approaches are the trait and preference approach. The trait approach suggests that individuals possess characteristics which are inherent, immutable, ‘hard-wired’ and stable over time, whereas the preference approach suggests that people are predisposed to certain behaviors and characteristics that have been developed and are also consistent over time and usage. However, to some extent a person can modify their behavior, if motivated to do so, in certain situations and contexts. The Big Five Personality Model is based on the trait approach and is said to provide a framework of personality that subsumes all personality behaviors. Many

psychometric questionnaires used to assess personality are based on the Big Five Model. In addition, there are questionnaires that are based on the preference approach; the Myers Briggs Type Indicator (MBTI) developed by mother and daughter (Briggs Myers et al, 1998) is one such measure that is widely used in a variety of settings such as education, counseling, career development and conflict resolution. MBTI is based on the work of Carl Jung (1921) whose seminal work on Psychological Type has provided a legacy to researchers interested in expanding the body of knowledge on personality differences.

According to Jung, an individual's personality or Psychological Type is based upon the development and use of four mental functions, two of which relate to how we perceive information, sensing and intuition and two which relate to how we make decisions, thinking and feeling and our attitude to the outer world expressed through the preference of extroversion or introversion. Jung's conceptual model suggests a person's Psychological Type is predisposed to different behaviors and preferences according to the development of each mental function and attitude.

Whilst the trait and preference approach differ conceptually, a research study by McCrae and Costa (1989) shows a relationship between the Big Five Factor model and the MBTI scales. The study showed that the four MBTI scales measure aspects of four of the five major dimensions of normal personality and that the five-factor model provides an alternative basis for interpreting MBTI findings within a broader, more commonly shared conceptual framework.

The descriptions of the MBTI scales given below are taken from the Introduction to Type handbook (Briggs Myers, 1998). Interpretation of the Big Five personality traits and correlations to MBTI preferences are shown below:

Table 1. Correlations between Big Five personality traits and MBTI preferences

<b>Big Five Trait</b>	<b>MBTI Dimension</b>	<b>MBTI scales</b>
Openness to Experience  (Positive correlation to <b>Intuition</b> )	Preferred way of taking in information	<b>Sensing:</b> Take information in that is real and tangible using the five senses. Trusts experience. <b>Intuition:</b> Take information in by seeing the big picture. Trusts inspiration.
Agreeableness (Positive correlation to <b>Feeling</b> )	Preferred way of making decisions	<b>Thinking:</b> Look for logical consequences in a situation. <b>Feeling:</b> Look to create harmony in a situation
Extroversion  (Inverse correlation to <b>Introversion</b> )	Preferred focus of attention / energy	<b>Extroversion:</b> focus on the outer world. <b>Introversion:</b> focus on the inner world.
Conscientiousness  (Inverse correlation to <b>Perceiving</b> )	Preferred way of dealing with the external world	<b>Judging:</b> Methodical and ordered approach to life. <b>Perceiving:</b> Spontaneity and casual approach to life.

The trait neuroticism which is referred to as emotional instability is not correlated with any of the MBTI scales.

Whichever approach to personality is considered, the notion of assessing, discussing and identifying aspects of an individual's personality, with or without their consent, in the public domain could be considered to be intrusive and unethical. If it were possible, therefore, to find an alternative way of assessing personality in a less intrusive way, it could open up an array of applications in many aspects of life.

Personality is typically assessed by observation or completion of psychometric questionnaires. Both these methods could potentially cause the person being observed or tested to consciously or unconsciously alter their behavior to suit a given purpose or desired outcome. However, when a person is engaging in normal social media interactions, it is unlikely that they are consciously trying to alter their personality and so their social media interaction patterns may provide a reflection of their true self. However, research indicates that for some people they use the virtual world of on-line interaction as a way of hiding their true self (Amichai-Hamburger, Wainapel & Fox; 2002).

## Technology and Personality

With the current technological revolution of social media and its pervasiveness into daily life, an interesting question that is raised is whether social media could provide a reflection of personality between that which exists in the real world with that which exists in the virtual world. Could social media activity output provide an alternative way to assess personality? A groundbreaking research study into such a question has been conducted by a collaboration between Cambridge University and Microsoft Research (Bachrach, Graepel, Kohli, Kosinski & Stillwell; 2012). This team conducted a study that examined personality and patterns of Facebook usage. Their findings have been significant in relation to assessing personality and correlations of social network use. Their results show that there are significant relationships between each of the Big Five personality traits and usage of Facebook features. Their methodology was based on frequency measures, for example, how many friends does a person have in their network; how many times has a person been tagged in photos; how many status updates has a person made and other similar measures? The study's findings show a prediction of personality traits given a user's Facebook profile and usage. These findings are summarized below:

Table 2. Prediction accuracy on personality traits and Facebook usage

Prediction Accuracy	Big Five Factor	MBTI Scale	Correlation
Best	Extroversion	Introversion	Inverse relationship
Best	Neuroticism	NA	NA
Middle	Openness	Intuition	Positive relationship
Middle	Conscientiousness	Perceiving	Inverse relationship
Lowest	Agreeableness	Feeling	Positive relationship

## RESEARCH QUESTION

According to Jung (1921) Introverts are private and contained individuals, whereas extroverts are social and expressive. Introverts like to focus on depth whereas extroverts tend to focus on breadth. In the actual world, extroverts and introverts behave in different ways. We wondered how these behavioral differences would be manifested in the digital world and what would these differences look like structurally? According to Bachrach et al, extroverts can be identified from their Facebook social media activity. Our area of interest focuses on what the network structure for an extrovert and conversely an introvert would look like? Using network theory and analysis, we speculate what the type of connections within and between introverts' and extroverts' network groups would look like structurally. More specifically we wondered whether a person's personality footprint is the same in the actual world as it is in the digital world; and how those differences might be

represented? Could these digital structural patterns provide an alternative way of identifying different personality types?

Our thinking and speculation about these factors led the research team to propose and test the following hypotheses.

### **Hypotheses**

1. *Extroverts will have more connections within their social media network than introverts.*
2. *The density of an extrovert's network will be more intense than that of an introvert's*

Our study intends to build on the work of Bachrach et al but with two specific differences.

The first difference is that this current study will examine the structure of an individual's social media network in order to identify specific network patterns that might be associated with different personality preferences.

The second difference is that the researchers have chosen to use the MBTI (Myers-Briggs Type Indicator) instrument as the tool for identifying the specific personality preferences. This is because existing MBTI data is available for the targeted sample population and it might allow for a greater differentiation in personality in that the combination of preferences result in 16 different Types. It is not the authors' intention to argue for or against the applicability of the instrument, as evidence and studies exist to support its strength. The body of literature on the validity and reliability of the MBTI contains many studies that have been carried out using the MBTI to predict or determine success in specific settings such as educative courses (Bispong, Patron; 2008) or as a way of helping to identify specific competencies for particular jobs, such as R & D Managers (Dreyfus, 2007).

The focus of this research project will examine the best prediction findings from the Bachrach et al's study and therefore concentrate on the MBTI Introversion / Extroversion scale. The research proposition of this study is predicated on the Cambridge Team's findings that an extroverted type's personality can be predicted from their social media usage. This current study is looking to establish what specific structural patterns exist within an extroverted type's social media network and by definition for an introverted type too.

### **METHODOLOGY**

This study takes a quantitative approach to data gathering and data analysis. We asked for volunteers from the current cohort of MBA students who are studying at the Asian Institute of Management to participate in this study as they had already undertaken the MBTI and would, therefore, know their MBTI Type. We used the

participants' MBTI data as well as data that were extracted from their personal Facebook social media networks. Mathematica 9 software was used to analyze the Facebook data files.

### Sample Population

Our sample population was drawn from the current MBA student community within our teaching institution (AIM) for the following reasons. First, on entry to the MBA program each student completes the MBTI for learning and development purposes and so an MBTI database already exists. Second, with average age of 26, the age range of these MBA students suggests that they are more likely to be social media savvy and to have a developed and active Facebook account.

The total number of students who participated was 49. As we were only interested in the Introversion / Extroversion scales, we show below the division in numbers between these two scales:

Table 3. Sample Data

Sample Size	Introverts Total number	Extroverts Total number
Total n = 49		
Sample n = 44	23	21

The reason for the discrepancy between the total number of participants and actual sample size used in the study was due to a few participants that were undecided about their best fit type in respect of the extroversion / introversion scales or that their network data were incomplete so we therefore had to eliminate them from the study.

### Ethical Considerations

The researchers were sensitive to the issues of confidentiality and anonymity. They approached the task of gathering data from the students' Facebook accounts in a way that would minimize concerns about how these personal datasets would be used and help to avoid situations where students felt they were not in control of producing and sending the requested data to the researchers. This was accomplished by setting aside some time at the start of one of the students' classes and walking them through the process step-by-step so that they could sign up to participate and produce the required data all at the same time. This meant that all questions, concerns and issues could be dealt with at a single point in time and everyone would receive the same instructions thus avoiding misinterpretation and misunderstandings.

The researchers assured the participants of confidentiality and that their data would be only used for research purposes. If participants wanted to maintain complete anonymity they were advised to set up and use an anonymous email account to send the dataset which would mean that there would be no traceable connection between a



particular dataset and an individual. Participants were assured that participation or non-participation in this project would in no way affect any of their grades or student assessments. Participation in the study was purely voluntary. The researchers also sought participants' permission to gain access to their MBTI data and only to use it in the context of the study. Participants were advised that they would be sent a copy of the journal article resulting from the study if they were interested in the final results.

## DATA ANALYSIS

Each of the 49 AIM MBA students who volunteered to participate in the research was asked to follow a procedure so that their Facebook friends network could be extracted using an app called Netvizz (Reider, 2010). They then sent the output file containing their network to the research team for processing along with their MBTI personality type indicator. However, only 44 were selected as their MBTI type was either indeterminate or their network data were incomplete.

Their friends' network data were processed using Mathematica 9 (Wolfram, 2013) software. A visualization of a Facebook friends network is shown in Figure 2.

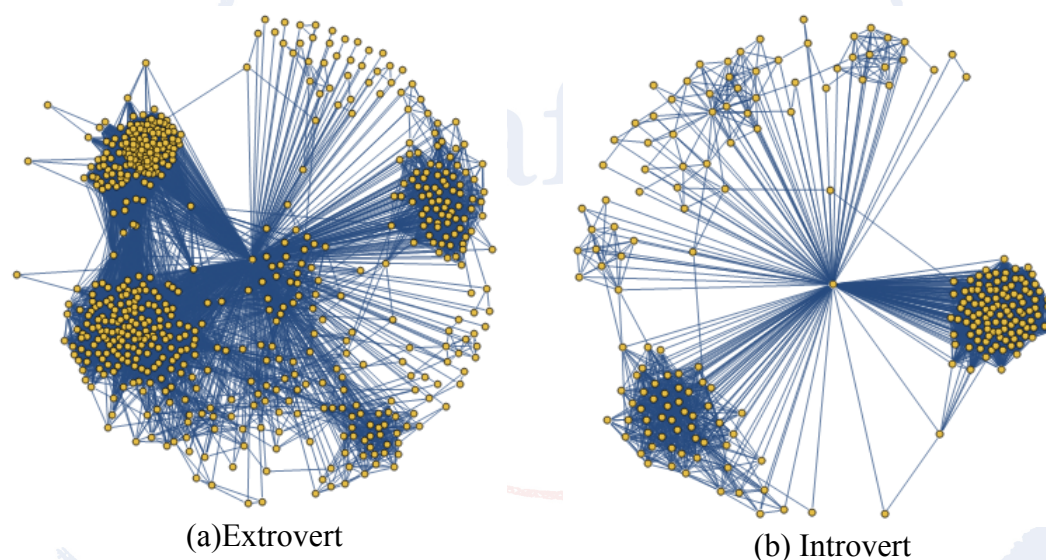

Figure 1. Sample friends network of an extrovert and introvert

The dots shown in the figure are the nodes of the network. The lines connecting the nodes are the edges. The node at the center is the person whose personality type we want to infer given the network structure.

Metrics to describe the structure of their network were computed. These metrics included number of friends (nodes) one is connected to and the number of connections the friends would have to each other (edges). We also measured the average degree (Jackson, 2008) which is the ratio between the total number of connections (edges) compared to the total number of friends (nodes).

We also computed the graph density (Jackson, 2008) to describe how the structure departs from a complete graph. A complete graph has a graph density of 1 which means all the nodes are connected to all the other nodes as depicted in Figure 3:

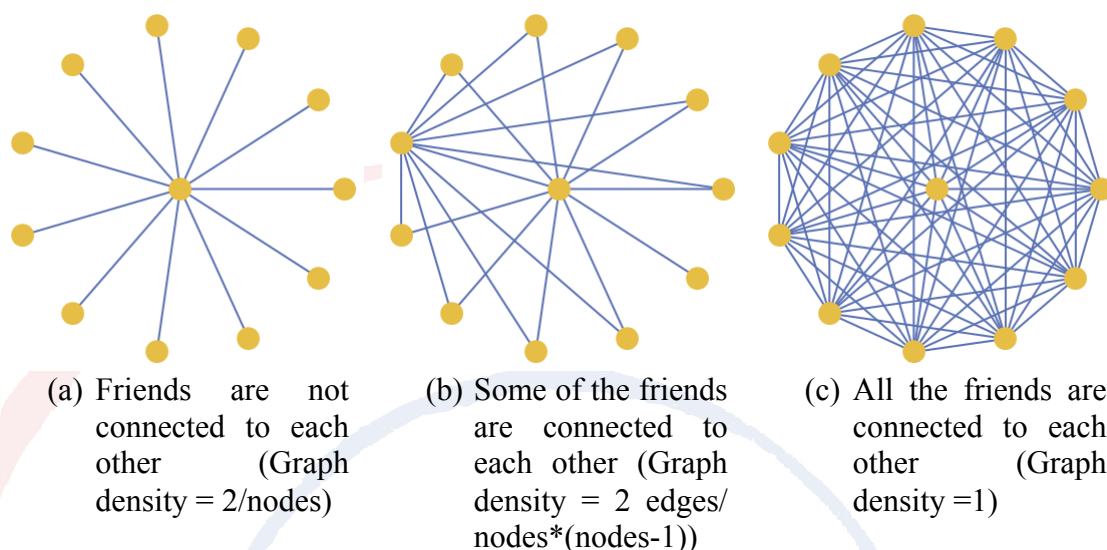

Figure 2. Graph density of the friends network

After looking at the individual connections, we considered how the nodes in the network are grouped. Instead of relying on Facebook's Groups (Facebook Groups, 2013) facility which depends on formal membership even though they are already connected, we look only at how dense the connections are among the nodes. We then use modularity (Newman, 2006) to algorithmically identify the communities formed by the nodes. By communities we mean grouping of nodes where the connections are more dense internally but sparser between nodes from a different community. For instance those, belonging to the same community would have high modularity and less if from different communities. Lastly, we also count the number of connected components to check the largest network a node is connected to (Freeman, 2004).

## FINDINGS

First, we acknowledge that the sample population is small and not representative of the general population but we wanted to run the project as a pilot study and a precursor to a follow-up study. Since beginning this project, we have been given access to the data that the Cambridge study has generated and thanks to their generosity we now have additional data resources to hand. We acknowledge that our findings are neither representative nor statistically significant, but the findings alert us to potential points of interest for our follow-up study. We, therefore, present our findings for discussion purposes.

We first considered the Extroverted and Introverted groups. From the different analyses mentioned above, we focused on 3 measures for these groups.

1. The number of nodes for extroverts is slightly bigger compared to introverts. The extroverts in our sample have on average 660 friends while the introverts have 585 friends. Superimposed on the graph is the standard error to give us an idea of the precision of the data.

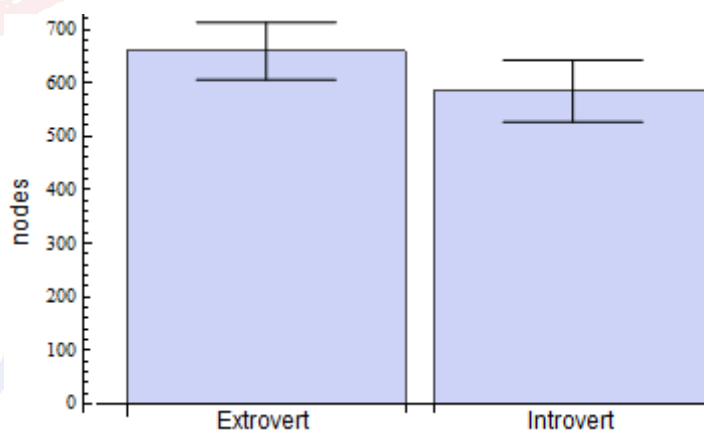

Figure 3. Number of Nodes for extroverted and introverted types

2. The number of edges for extroverts is slightly bigger compared to introverts. The personal network of an extrovert has about a thousand more connections than an introvert (17457 vs. 16680).

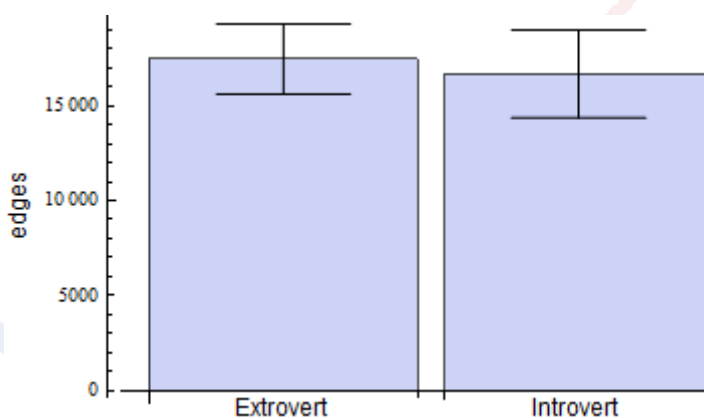

Figure 4. Number of edges for extroverted and introverted types

3. The value of the graph density for the extroverted group is slightly lower than the introverted group.

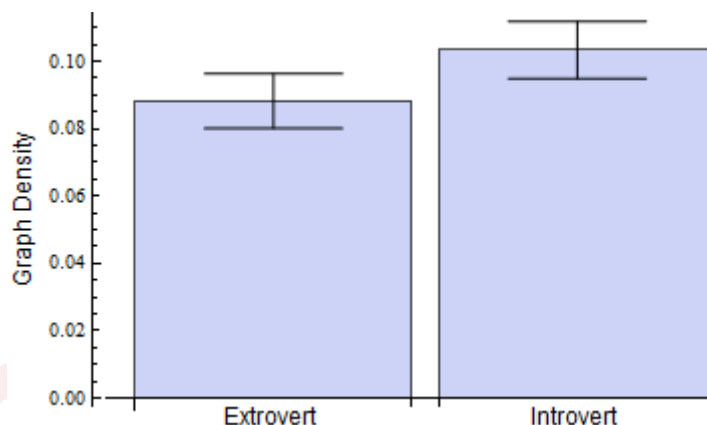

Figure 5. Graph density of extroverted and introverted types

## DISCUSSION

We first look at the comparisons between the introverts and extroverts groupings.

1. The comparison of nodes which represents the number of friends a person has, in our study, suggests that extroverts have more friends than introverts or put another way, introverts have less friends than extroverts. The explanation for this could be as extroverts need to have social interaction with people and events in the external world they may find it easier to connect to people on Facebook than introverts. They may be replacing the external world with the cyberworld and may be substituting cyber connections for real connections. This finding is in line with that of the Cambridge study (Bachrach, et al; 2012) that found people who have a high degree of extroversion had more friends than those who had a lower degree of extroversion.
2. When comparing the number of edges, which represents the number of connections between friends, for the extroverts groups to the introverts group, the number was slightly bigger for extroverts. This could be explained by the fact that extroverts have more friends to begin with.
3. But even though extroverts have more friends to begin with, when comparing the graph density, introverts have more concentrated connections between friends than extroverts suggesting a tighter-knit grouping of people. A speculative explanation for this might be that extroverts might act like 'Social Butterflies', they are happy to have 'open-ended' connections and lots of them whereas introverts are selective about their connections and will only let people into their network after careful consideration and selection. Following the notion that extroverts go for breadth and introverts like depth, it could be that each group applies this concept to their virtual relationships as well.

After further analyses, we noticed something interesting, although the numbers are very small, we felt it was worth highlighting and adding into the discussion. We added the additional scale of Perceiving to the Extrovert and Introvert groups and

produced two new groups; Extroverted Perceiving types, EPs and Introverted Perceiving types, IPs. The comparison of nodes and edges between EPs and IPs produced the same trend as the pure extrovert and introvert groups but these differences were magnified. In addition, we found something interesting when analyzing the number of communities and connected components.

When we looked at the number of communities for the Extroverts and Introverts we expected the trend of Extroverts having more than Introverts to continue and it did, even though the difference was small. Similarly, we saw the same trend for extroverts to have more than introverts when we compared the number of connected components, (Figure 7, below)

However, when comparing the number of communities and the number of connected components for EPs and IPs (See Figure 7, below) we found this trend was reversed in that IPs had a bigger number of communities than EPs and IPs had a bigger number of connected components than EPs. It seems that this ‘introverted’ group (IP) is exhibiting more extroverted type behavior. The limited sample size and high standard deviation among IPs show a higher standard error.

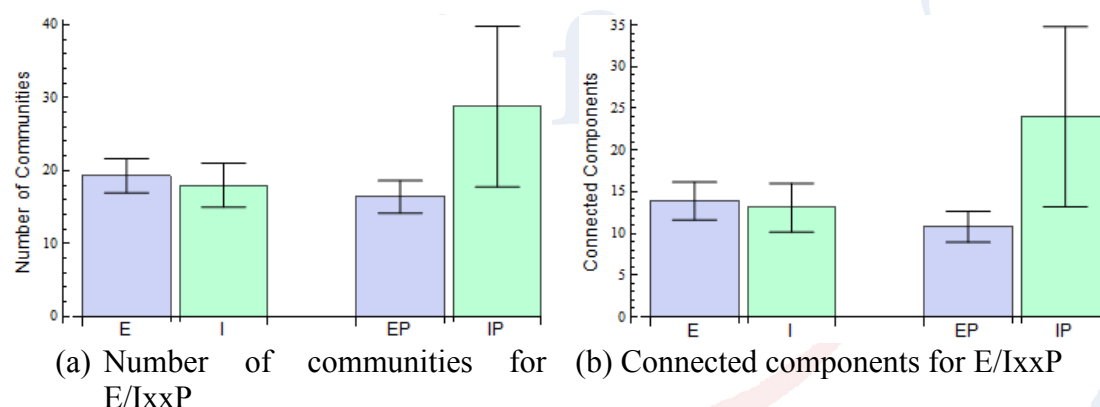

Figure 6. Comparison for E/I and E/IxxP

In MBTI terms, EPs are known as ‘Adaptable Extroverts’ and IPs are known as ‘Adaptable Introverts’. A possible explanation for this unusual anomaly might be that by adding the additional dimension of Perceiving to both extroversion and introversion adds the characteristics of spontaneity; flexibility and open-endedness. To some extent, these characteristics are already present in an extrovert and so could be either cancelled or leveled-out in the EP group, therefore, having no additional effect; whereas for introverts these characteristics are absorbed and treated as an additional component of their type. This combination of introversion and perceiving may cause introverted types to express more extroverted behavior. It is as though the IP group is emulating the extroverted ‘Social Butterfly’ effect.

## **Hypotheses**

At the start, the project set out to test two hypotheses:

1. *Extroverts will have more connections within their social media network than introverts.*
2. *The density of an extrovert's network will be more intense than that of an introvert's*

Our initial findings suggest that the first hypothesis is supported although we cannot claim any statistical significance due to the small sample size. Our data tentatively shows that the second hypothesis is in fact reversed; the density of an introvert's network seems to be more intense than that of an extrovert's. It is our intention to follow up and further examine these tentative findings by increasing our existing sample population so that all MBTI types are represented. We will also consider how the Cambridge Team's database could provide an additional resource that may help to further investigate these initial findings.

## **CONCLUSIONS**

This pilot study has helped to set the direction for further research. It appears that extroverts are more likely to engage differently than introverts with social media platforms, such as Facebook and therefore, each group appears to produce a different network structure. What has also been interesting and is worthy of further investigation is that when adding another dimension to the extrovert / introvert dimension, a different network structure is produced yet again. This adds credibility to the idea that it could be possible that each of the 16 MBTI types could produce different and possibly discrete network structures. So instead of treating personality groups as single entities, such as, extroverts or introverts, the MBTI already allows the categorization of personality into 16 different types. As we have seen by adding in another dimension to a single entity, a richer picture of a network structure is produced, as demonstrated by the additional Perceiving dimension to extroverts and introverts. If each of the MBTI personality types can be found to have typical, individualized network structures, it would suggest that each MBTI type could be identified through their own typical network structure. These datasets could offer an alternative way of assessing personality in line with the digital age in which we live. In addition, this information would allow further segmentation of groupings by personality type and could open up a range of applications that would enable each type to be specifically targeted for marketing and communication purposes.

## **LIMITATIONS**

We acknowledge the limited sample size used in this study. This was in part due to the voluntary nature and response rate of participation. Whilst the researchers used an efficient way to gather the data, the drawback was that once participants left the classroom environment it proved difficult for the researchers to maintain the levels of



enthusiasm and motivation to participate that was initially evident. We also accept that the sample population was drawn from our institution's student community which is not representative of the general population. It would be our intention when conducting further research to expand the size and diversity of the sample population.

Another limitation to the study is the MBTI questionnaire itself and the opportunity to find participants who have both completed the questionnaire and have an active Facebook account. There are also resource limitations for completing the MBTI, both in terms of cost and time.

### **FURTHER RESEARCH**

At the start of this project, it was intended to run this project as a pilot study to see whether our methodology was able to replicate some of the results of the Cambridge Team's study but using the MBTI framework instead of the five-factor model and particularly to examine what differences might exist between extroverts and introverts in terms of their network structures. Whilst our tentative findings do show that differences in network structures exist for these one-dimensional groupings, our findings and thinking have been further stimulated by the idea that adding in additional dimensions to personality, which the MBTI allows, more marked differences might be found. This line of investigation will be the subject of a follow-up study.

### **REFERENCES**

- Amichai-Hamburger, Y., Wainapel, G., & Fox, S (2002) On the Internet no one knows I'm an introvert: Extroversion, neuroticism and Internet interaction. *Cyber Psychology and Behavior*, 5, 125-128
- Bachrach, Y., Kosinski, M., Grapel, T., Kohli, P., Stillwell, D., (2012) Personality and Patterns of Facebook Usage. *Web Science 12*, June 22-24, 2012, Evanston, IL. USA
- Bispong, T.O & Patron, H. (2008) Personality Type as a determinant of Student Success in Introductory General Business Courses. *Academy of Educational Leadership Journal*. 12.1 30-50
- Briggs Myers, I., (1998) *Introduction to Type*. Consulting Psychologists Press Inc: Palo Alto, CA
- Burt, R.S. (1998). "Personality correlates of structural holes" in R.M. Kramer and M.A. Neale (eds.), *Power and Influence in Organizations*. Thousand Oaks; London; and New Delhi; Sage Publications

Dreyfus, C.R (2007) Identifying Competencies that predict the effectiveness of R&D Managers. *Journal of Management Development*. Vol 27. No 1: pp76-91

Facebook Groups. <http://www.facebook.com/about/groups>. Accessed 21/03/2013.

Freeman, L.C. (2004). The Development of Social Network Analysis: A Study in the Sociology of Science. Empirical Press.

Jackson, M.O. (2008). Social and Economic Networks. Princeton University Press, Princeton.

Jung, C. G. (1921) Psychological Types. English Edition. Collected Works, Volume 6, Princeton, N.J.: Princeton University Press

Maehle, N. & Shneor, R. (2010) On Congruence between brand and human personalities. *Journal of Product & Brand Management*. Vol. 19, No. 1 44-53

McCrae, R. R., & Costa, P.T. (1989) Reinterpreting the Myers-Briggs Type Indicator From the Perspective of the Five-Factor Model of Personality. *Journal of Personality*. Vol. 57 Issue 1 pp17-40

Myers, Isabel Briggs, Mary H. McCaulley, Naomi Quenk, and Allan Hammer. (1998) MBTI Handbook: A Guide to the development and use of the Myers-Briggs Type Indicator Consulting Psychologists Press: Palo Alto, 3rd edition

Newman, M. E. J. (2006). "Modularity and community structure in networks". *Proceedings of the National Academy of Sciences USA* **103** (23): 8577–8696.

Reider, B. (2010) Netvizz. <http://apps.facebook.com/netvizz/>. Accessed 21/03/2013.

Seung-A, A.J. (2012) The potential for social media for luxury brand management. *Marketing Intelligence & Planning*. 30.7 687-699

Wolfram Research (2013) Mathematica 9. <http://www.wolfram.com/mathematica>

*The Level of Social Bond among Indonesian Higher-Education Students Who Access Facebook*

Azalia Primadita Muchransyah, Tri Iswardani A

Universitas Indonesia, Indonesia

0153

The Asian Conference on Psychology & the Behavioral Sciences 2013

Official Conference Proceedings 2013

Abstract

Along with technological advances and the rapid flow of information, people's need to access the internet is increasing. According to data held by [www.internetworldstats.com](http://www.internetworldstats.com), a site which monitors internet usage in the on-line world, the number of internet users in Indonesia reached 25 million in 2008. This is because, aside from its role as a source of information, the internet also serves as a tool for learning and recreation. In this study, we would like to enquire into the level of social bond among Indonesian students who have experienced Facebook addiction. Facebook continues to grow in popularity, especially among students, who have a tendency to see it as a psychological substitute for increasingly fragile social bonds between people. Therefore, for individuals who have weak social bonds, Facebook can cause addiction. We define social bond as the relationship of an individual to his/her society. A social bond is composed of four key elements: attachment, commitment, involvement, and belief. This study aims to outline the character of the social bond among Indonesian students who access the site Facebook. Research was carried out through both quantitative and qualitative methods. With regards to the former, 214 respondents were split into three groups: (1) those with Facebook addiction, (2) those having problems due to their use of Facebook, and (3) average Facebook users. Our qualitative research consisted in interviews with two respondents: our first respondent has a Facebook addiction with a high level of social bond, and the second has a Facebook addiction with a low level of social bond.

Keywords: social bond, Facebook, addiction.

## BACKGROUND

Along with advances in technology and the rapid flow of information, the need for people to access the Internet is increasing. According to [www.internetworldstats.com](http://www.internetworldstats.com), a site that continues monitoring the use of the internet on-line, in 2008, internet users in Indonesia the number of users reached 25 million. This is because, aside from serving as a source of information, the internet also serves as a tool for learning and recreation.

Based on data obtained from [www.alexa.com](http://www.alexa.com), an on-line site that monitors access to the entire site around the world, Facebook was ranked the fourth most accessed site worldwide after Google, Yahoo!, and YouTube. In Indonesia, Facebook was ranked third behind Google and Yahoo! This makes Facebook the most popular social networking site, both in Indonesia and worldwide.

Based on [AllFacebook.com](http://AllFacebook.com), which provides statistical data of Facebook users around the world, the majority of Facebook users in Indonesia are between the ages of 18-25 years. The age span falls in the category of young adults, according to both Havighurst, who defines the category of young adult as corresponding to the age range 18 to 35 years, and Bigner (1994), who states young adulthood begins when the individual reaches the age of 18 and continues until the age of 45. Those who are in the age range 18-25 years are generally those who are in college or university students.

According to Arthur T. Horvath, Ph.D., ABPP from Center for Cognitive Therapy (in Basyuni, 1999), addiction is an activity or situation that we want to experience over and over again, and to that end, if necessary, we are willing to pay (or accept the negative consequences). In recent years studies have shown that there are examples of substances addictions (alcohol, cigarettes, food, drugs, etc.) and activities addictions (gambling, impulsive sexual activity, shoplifting, shop too much, etc.). Rich and Copans (2000) state that most people associate addiction exclusively with substance abuse, yet addictive behaviors can have a broader meaning. The key to addiction is an obsessive and compulsive need for substances, objects, relationships, activities, or other things. It should be emphasized that addiction is more about the response, wants, and needs of someone for something, not the thing itself. It may therefore be said that a person may be addicted to almost anything, including Facebook.

In his article "The Roots of Addiction in Free Market Society", Bruce K. Alexander (2001) notes that addiction in the modern world can best be understood as a compulsive lifestyle in which individuals in desperation seek a form of substitution after undergoing dislocation from their core closeness, a bond between themselves and groups—from family to spiritual community— essential for each individual in different types of societies. The article also suggests that dislocation is an important cause of addiction, and using examples from the history of Canada and Scotland he

showed that the creation of the free market—the internet being one of its products—led to the spread of dislocation to the poor and the rich. As free market globalization increases, so does the spread of dislocation and addiction.

Humans who are not able to reach psychological integrity in the form of a bond between themselves and their groups develop a “substitution” lifestyle which is accompanied by destructive habits, including, though not limited to, the use of illegal drugs and relationships that do not have the quality of closeness, are not stable, or culturally acceptable to add to their minimum psychological integration. Those who cannot find a better way to achieve psychological integration depend on their substitute lifestyle to a level of intensity corresponding to addiction. This is consistent with the theory of social bond formulated by Travis Hirschi who states that deviant behaviors, including addiction, occur when someone has weak or even zero level of social bond.

With this description in mind, the researchers want to enquiry into the level of social bond among Indonesian students who have experienced Facebook addiction. Facebook is chosen because it is currently very popular, especially among students, for whom it often serves as a psychological substitute for increasingly tenuous social bonds in the community. Therefore, for individuals who have weak social bonds, Facebook can lead to addiction.

## **RESEARCH QUESTIONS**

The key question to be answered through this study is “Is there any relationship between Facebook usage patterns and social bonding among Indonesian students?” This question is then followed by derivative questions based on the four elements of social bond, namely: (1) “Is there any relationship between Facebook usage patterns and attachment among Indonesian students?”, (2) “Is there any relationship between Facebook usage patterns and commitment among Indonesian students?”, (3) “Is there any relationship between Facebook usage patterns and involvement among Indonesian students?”, and (4) “Is there any relationship between Facebook usage patterns and belief among Indonesian students?”

## **LITERATURE REVIEW**

### **A. Social Bond**

Social bond is the relationship between the individual and society (Shoemaker, 2005 in Durkin et al., 2007). According to Travis Hirschi (in Durkin et al., 2007), the sociologist who formally introduced the theory of social bond: “human beings are

moral beings as an extension of their existence as a social being.” Social bond theory assumes that emerging motivation of deviant behaviors exists in all people, and concern over this behavior is exactly what makes an individual persists in deviant behavior. When social bond is weak or even nonexistent, individuals have less regard for to sacrifice their time and energy towards socially acceptable behaviors and are at a higher risk of committing deviant behaviors (Faupel, Horowitz, & Weaver, 2004 in Durkin et al., 2007).

According to Hirschi (in Durkin et al., 2007), there are four elements of social bond—attachment, commitment, involvement, and belief. Attachment refers to the bond between individuals with their significant others, such as family members. The second component of social bond is commitment, which refers to the amount of investment of time, effort, and resources in conventional activities such as getting an education or a job. These investments represent the stages of conformity (Akers, 1997 in Durkin et al., 2007). The third element of social bond is involvement. This aspect consists in the amount of time a person invests in conventional activities, such as school/college work or participation in extra-curricular organizations. The final component of social bond is belief, which is the acceptance of the value of the conventional system.

In this study, the operational definition of social bonds employed concerns the strength or weakness of the relationship between individuals and society which prevent them from committing deviant behaviors. Social bond is itself measured on the basis of four elements, namely attachment, commitment, involvement, and belief. Thus, it can be inferred that deviant behaviors, including addiction, may occur when attachment, commitment, involvement, and belief is weak or nonexistent.

## **B. Addiction**

Marlatt, Baer, Donovan, and Kiulahan (in Thombs, 1999) provide an operational definition of addictive behavior: a repetitive habit that increases the risk of disease and/or personal and social problems associated with it. Addictive behavior is often subjectively experienced as a loss of control (out of control) so that the behavior occurs again despite trying to end or decrease use of the substance. DSM-IV-TR (American Psychiatric Association, 2000) states that the definition of substance dependence is a compulsive substance abuse that is at least partly biological and partly due to encouragement beyond personal control. Psychoactive drugs, for instance, are very rewarding (positively interpreted by the brain) and reinforcing (Hyman et al., 2001 in Thombs, 1999).

Maladaptive Facebook access leads to destruction or clinically significant distress manifested by three or more symptoms based on DSM-IV criteria and can occur at any time within 12 consecutive months (Ivan Goldberg, 1996 in Basyuni, 1999). These criteria have been modified to the ends of the case study as follows: :



1. Tolerance: The need to access Facebook increases with the aim of achieving a sense of pleasure.
2. The symptoms of a desire to access Facebook that usually arises when off Facebook (for example, when offline).
3. Accessing Facebook in larger quantities (frequency) or within a longer period of time (duration) than intended.
4. The desire to reduce or control the activities of accessing Facebook.
5. Too much time spent in accessing Facebook, looking for ways to be able to access Facebook, or refrain from accessing Facebook activities.
6. Decreasing social activities, work, or recreational activities caused by accessing Facebook.
7. Continuing to access Facebook despite the consequences of physical or psychological harm.

### **C. Theoretical Dynamic**

Addiction to Facebook arises as a compulsive behavior which occurs because of the need to find a substitute for a weak level of social bond. Having managed to satisfy their social needs by accessing Facebook, some will continue to increase the activity to generate further positive emotions. Accessing Facebook, which originally as a substitute activity, becomes a habit and it takes on a compulsive character. Recurring and chronic Facebook addiction can have damaging consequences for one's life.

From a social perspective, addiction has four functions, one of which is the facilitation of social interaction (Thombs, 2006). In this case, addiction is used as a means to enhance the level of social bond. A person's level of social bond may prevent him/her from committing deviant behavior. This means that deviant behavior, including addiction, occurs when the four elements of the social bond—attachment, commitment, involvement, and belief—of a person is weak or nonexistent. Individuals who cannot achieve psychological integration in the form of a bond within themselves and a group develop a "substitution" lifestyle that is accompanied by destructive habits. Those who cannot find a better way to achieve psychological integration depend on their substitution lifestyle with a level of intensity amounting to addiction.

### **RESEARCH METHODOLOGY**

In this study, there are two research approaches employed, both quantitative and qualitative approaches. Based on its objective, this study belongs to the category of descriptive study. Descriptive studies occur when researchers want to see a detailed and specific description of a situation or social setting, or a relationship between them (Neuman, 2003).

## **A. Research Variables**

The variables used in this study are the level of social bond and patterns of Facebook usage for students in Indonesia.

According to Shoemaker (2005) social bond refers to the relationship between individual and society. Social bond has four elements, namely attachment, commitment, involvement, and belief.

In measuring Facebook usage patterns, indicators used are the elements of the pattern of Facebook usage in the adaptation version of the IAT questionnaire (Widyanto and McMurrin, 2004), namely (1) Salience or closeness towards Facebook; (2) Excessive use; (3) Neglected works; (4) Anticipate to regain access to Facebook; (5) lack of control; and (5) Neglected social life.

## **B. Research Subjects**

Respondents who are studied in this research are the individuals that have the following characteristics:

1. Research subjects are Indonesian citizens residing in Indonesia. This is because the study wants to enquire into the level of social bond among Indonesian students who have tendencies towards Facebook addiction.
2. Research subjects are students. In accordance with the research by Aryn Karpinski (2009) from Ohio State University, USA, who claim that the preoccupation with accessing Facebook can adversely affect the academic achievement of students, researchers want to gain a deeper understanding of Facebook usage of students in Indonesia, associated with addiction, with social bond as a contributing factor.
3. Research subjects are in the age range of 18-25 years. This is because the subjects to be studied are students, who are in the young adult development stage, which is also the highest age range number of Facebook users in Indonesia.
4. Research subjects have had a Facebook account for at least the past year. The reason for this criterion is that the researchers want to see the trend of addiction which according to DSM-IV criteria may occur at any time within 12 consecutive months (Ivan Goldberg, 1996 in Basyuni, 1999).

## **C. Sampling Technique**

This study uses sampling method of non-random/non-probability sampling, because the exact number of the population to be measured is not known by researchers (Kumar, 1999), given the number of students who are spread all over Indonesia. The sampling technique used is accidental sampling, in which researchers will take

samples that are easily accessible in accordance with the characteristics of respondents who researchers have specified.

## D. Research Instrument

### 1. Questionnaire

Questionnaires were distributed over the period of one week and were distributed online via the creation of an account on the site FreeOnlineSurveys.com and information about the questionnaire was spread via Facebook, e-mail, and mailing lists. To control the characteristic profile of the subjects, the researchers provide a column in which the characteristics of subjects could be selected.

Measuring tool used to measure the tendency of Facebook addiction was an adaptation of the instrument of Internet Addiction Test (IAT) developed in 1995 by Dr. Kimberly Young, a professor at St. Bonaventure University, USA, who is also an expert in the field of internet addiction. This questionnaire used the Likert model consisting of five scales. Answers' scorings were "never": 1, "rare": 2, "sometimes": 3, "often": 4 and "always": 5. The total score obtained by taking the sum of all scores of the 19 items there. Thus, the existing score range was 19-95. Subjects were categorized by determining group norms derived from the Z-score calculation. Results were interpreted by placing a value on the Standard Deviation of the following ranges (each category ranges 1.94 SD):

-2.03 SD up to -0.09 SD	: Average Facebook user
-0.09 SD up to 1.85 SD	: Those who have some problems because of Facebook
1.85 SD up to 3.79 SD	: Those who have significant problems because of Facebook, which are categorized as those who have Facebook addiction.

In the Facebook Usage Pattern Measuring Tool, the alpha coefficient reliability value obtained was equal to .8923, which means that the measuring tool was reliable because it was above .60 (Gronlund, 1985 in Kerlinger & Lee, 2000, Aiken, 2006). Validity obtained for each item varied in the range of .403 to .781, which means each item had a significant correlation with the total score obtained at the level of .01 (1-tail). Only one item had a low validity: item 9 ("How often do you keep to yourself what you're doing when you access Facebook?") which had a validity of .125. So the researchers decided to eliminate the item number 9 given that that the dimension measured by the item would still be represented by two other items in the same dimension. Thus, by eliminating the item number 9, the Facebook Usage Pattern Measuring Tool had 19 items with the value of the reliability coefficient alpha of .9017.

The Social Bond Measuring Tool was created by Keith F. Durkin of Ohio Northern University, USA in 2007. It uses the theory of Hirschi (1969) which states there are four elements of the social bond—attachment, commitment, involvement, and belief. Prior to using the measuring tool, the researchers contacted Keith F. Durkin via e-mail. The translation and adaptation were carried out after permission was obtained from Keith F. Durkin.

The questionnaire consisted of 14 items that measured a person's social bond. The scores detecting the subject's level of social bond were obtained by creating group norms based on the scores obtained by all respondents. This questionnaire used a Likert scale consisting of six scales titled accordingly: "very inappropriate": 1, "inappropriate": 2, "somewhat inappropriate": 3, "somewhat appropriate": 4, "appropriate": 5 and "very appropriate": 6. However, there was one item (item number 11) which used a reversed scoring system (reversed item). Scoring of this item was "very inappropriate": 6, "inappropriate": 5, "somewhat inappropriate": 4, "somewhat appropriate": 3, "appropriate": 2, and "very appropriate": 1.

The Social Bond Measuring Tool had an alpha coefficient reliability value of .6218, which entails that the measuring tool was reliable because it was above .60 (Gronlund, 1985 in Kerlinger & Lee, 2000, Aiken, 2006). Although one dimension (belief) had a low reliability value of 0.0139, but the items were retained because overall they had good reliability and the dimension only had few items so if the items were not retained, the dimension and sub-dimensions to be measured would not be represented by other items in the measuring instrument. Meanwhile, the validity of measurements obtained figures ranging from .294 to .617, which means that each item had a significant correlation with the total score obtained at the level of .01 and .05 (1-tail). Only two items scored low validity: item 8 (.258) and 11 (.237). However, both items were retained because they both constitute a sub-dimension only represented by a single item.

The Social Bond Measuring Tool consisted of 14 items with a response scale that had a range of values of 1 up to 6 so that the range of scores obtained was 14 up to 84. In categorizing the subject, the group norms were determined by deriving the Z-score calculation. Results were interpreted by placing a value on the Standard Deviation of the following ranges (range of each category 3.565 SD):

-4.61 SD up to -1.045 SD : low social bond  
-1.045 SD up to 2.52 SD : high social bond

## **2. Interview and Observation**

In this research, interviews conducted were interviews with general guidelines, to make sure all important topics to be asked were included. In addition, the researchers also used a technique of observation of the physical condition and behavior of the

subjects during the interview and observation of each interviewed respondent's Facebook account.

## RESULT

The number of respondents who completed the questionnaire was 250, although the responses open to being processed amounted 214. 150 subjects were female (70.1%) while the remaining 64 were male (29.9%). The respondents were in the age range of 18-25 years old – 7 people aged 18 years old (3.3%), 16 people aged 19 years old (7.5%), 24 people aged 20 years old (11.2%), 72 people aged 21 years old (33.6%), 62 people aged 22 years old (29.0%), 21 people aged 23 years old (9.8%), 9 persons aged 24 years old (4.2%), and 3 people aged 25 years old (1.4%). Based on place of domicile, subjects completing the study came from 16 cities spread over four islands in Indonesia, namely Java, Sumatra, Sulawesi and Bali. Most respondents came from Jakarta, amounting to 84 people (39.3%). Respondents were all active students from a variety of different colleges/universities. There were 41 colleges/universities with as many as 100 people (46.7%) from Universitas Indonesia. With regards to educational status, we found one two-year diploma (D2) student (.5%), 2 three-year-diploma (D3) students (.9%), 202 college (S1) students (94.4%), and 9 master degree (S2) students (4.2%).

The number of subjects belonging to the category of average users of Facebook was 110. The number of those who belonged to the category of Facebook users who had problems as a result of use of Facebook was 94, while those classified as having Facebook addiction were 10 people. Respondents who had a high level of social bond amounted to 188 people, while respondents with low social bond amounted to 26 people.

From the quantitative result, the researchers then conducted interviews and observations of two subjects. The first subject has the initials of T, a female, aged 22 years old. The second subject has the initials of G, a male, aged 22 years old.

Both subjects were both experiencing Facebook addiction and were aware of their circumstances. Both also had the same unlimited internet connection facilities in their homes. The differences lie in the orientation of the usage of Facebook. T saw Facebook more in terms of a lifestyle choice which gave her pleasure: as a means of receiving gossip and updates about the people around her, while G saw Facebook as a major media interaction. This was closely related to differences in social bonding between the two subjects, in which subject T had a high level of social bond while G had a level of low social bond. While T made Facebook as a means to increase pleasure, G made Facebook a “substitution” of his low level of social bond. Another difference lies in their different perspectives on their Facebook addiction. T felt that her Facebook addiction was proof of her status as being up-to-date, while G did not pay much attention to this consideration. T was also still able to live a normal life



involving commitment, although somewhat distracted by Facebook, while G had difficulty completing his thesis even though he had no other activities.

## **CONCLUSIONS**

From the results obtained, it was concluded that there is a significant relationship between the tendencies of Facebook addiction and the level of social bond among Indonesian students, with the value of correlation of  $-.152$  (significant at the level of  $0.05$ , one-tailed). This entails that the higher one's social bond, the less one is likely to suffer from Facebook addiction. Conversely, the more likely a person is to suffer from Facebook addiction, the lower the level of social bond.

This study also noted a correlation between Facebook addiction and each elements of social bond, which are attachment, commitment, involvement, and belief, where it turns out that there are no significant relationship with these elements; except for commitment, that has a Pearson correlation value of  $-.148$  (significant at the level of  $0.05$ , one-tailed). It shows that the relationship between Facebook addiction tendencies and commitment is of an inversely proportionate character: the higher the tendency towards Facebook addiction, the lower the person's level of commitment. On the contrary, the higher the commitment, the less likely one is to have a Facebook addiction.

## **DISCUSSIONS AND RECOMMENDATIONS**

Based on the results of the study, it was found that there was a significant relationship between the two core variables studied, namely social bond and patterns of Facebook usage. On the other hand, the pattern of Facebook usage only has a significant relationship with commitment, not with other elements of social bond (attachment, involvement, and belief). This may be due to different cultural values held by Indonesians compared to the western world where the social bond theory was first popularized. There are, for example, different patterns of closeness to parents: in Indonesia it is reasonable for a child to be close to his/her parents even after he/she has married and begun a family.

Judging from the measuring instruments used in this study, further researches can integrate more typical Indonesian cultural values, for example the strong religious culture in Indonesia that can affect one component of social bond: commitment. The component of commitment should be in line with the involvement component, in which a person with a commitment to social norms should behave contributing to his/her involvement in the related activities directly in everyday life. However, in the measuring tool used in the study it was found that the realization of involvement in one's commitment is only related to learning and work and does not include, for example, religious activities. It could be a consideration for future studies in order to



further develop the questions related to these two components. Therefore, further research could be carried out by developing existing tools serving to enhance the items contained in the Facebook Usage Pattern Measuring Tool and Social Bond Measuring Tool so as to enhance not only their reliability and validity, but also become more adapted to the cultural values of Indonesian society. We also found some cases in which a person experiencing Facebook addiction apparently can still have a high social bond. This suggests addiction to Facebook is not caused solely by a low level of social bond, but may be influenced by many other factors such as level of education and access to the internet.

Subjects examined in this study were limited to students in Indonesia; whereas in fact, Facebook users in Indonesia are not limited to only students. Further researches can also be carried out by widening the range of subjects in terms of characteristics and social background, such as housewives, K-12 students, or employees. Researches could also be carried out between two or more groups of people with contrasting work backgrounds, such as those who work alone or in teams. Citizens living abroad could also prove to be an interesting object of research, assuming they have a different level and character of social bond compared to those living in the country of their birth and interacting with people coming from the same country. Studies could also be developed further by looking at Facebook as a phenomenon of addiction that can be assessed not only by the social bond theory alone, but according to other approaches, such as personality theory, psychoanalysis, and so on.

## REFERENCES

- Aiken, L. R. (2006). *Psychological Testing and Assessment*. Boston: Pearson.
- Alexander, Bruce K. (2001). *The Roots of Addiction in Free Market Society*. Canada: Canadian Center for Policy Alternatives.
- American Psychiatric Association. (2000). *DSM-IV-TR: Diagnostic and Statistical Manual of Mental Disorder Text Revision* (4<sup>th</sup> ed.). Washington, DC: American Psychiatric Association.
- Basyuni, Mouna Fakhriani. (1999). *Keberadaan Internet Addiction Disorder Pada Dewasa Muda Berwarganegara Indonesia*. Depok: Fakultas Psikologi Universitas Indonesia.
- Durkin, Keith F., Scott E. Wolfe, & Ross W. May. (2007, September). Social bond theory and drunk driving in a sample of college students. *College Student Journal*. USA: Thomson Gale & Goliath.
- Grabmeier, J. (2009). *Study Finds Link Between Facebook Use and Lower Grades in College*. 20 Mei 2009.  
<http://researchnews.osu.edu/archieve/facebookusers.htm>
- Kerlinger, F. N. (2000). *Foundations of Behavioral Research*. London: Wadsworth.
- Kumar, R. (1999). *Research Methodology: A Step By Step Guide for Beginners*. London: SAGE Publication.
- <http://AllFacebook.com> [accessed on: 7 April 2009]
- <http://www.alexacom> [accessed on: 7 April 2009]
- <http://www.internetworldstats.com> [accessed on: 7 April 2009]

- Neuman, W. L. (2003). *Social Research Methods: Qualitative and Quantitative Approach*. Boston: Allyn and Bacon.
- Rich, Phil & Copans, Stuart A. (2000). *The Healing Journey Through Addiction*. USA: John Wiley & Sons, Inc.
- Thombs, Dennis L. (1999). *Introduction To Addictive Behaviors*. New York: The Guilford Press.
- Widyanto, Laura, Ph.D. & Mary McMurrin, Ph.D. (2004). *The Psychometric Properties of the Internet Addiction Test*. *Cyber Psychology & Behavior*, Volume 7, Number 4, 2007. USA: Maey Ann Liebert, Inc.

The logo for 'iafor' is centered on the page. It consists of the lowercase letters 'iafor' in a light blue, sans-serif font. The text is enclosed within a circular graphic composed of two overlapping, hand-drawn style arcs. The outer arc is a light red color, and the inner arc is a light blue color, matching the text. The arcs are not perfectly circular and have a slightly irregular, brush-stroke-like appearance.

iafor

*The Role of Empathy in Experiencing of Loneliness of Others and Existential-  
Behavioral Training in the Empathy Development.*

Emma Meshcheryakova\*<sup>1</sup>, Elena Litke\*<sup>2</sup>

\*<sup>1</sup>Tomsk State University, Russia, \*<sup>2</sup>Retirement Fund of Tomsk Region, Russia

0202

The Asian Conference on Psychology & the Behavioral Sciences 2013

Official Conference Proceedings 2013



iafor

iafor  
The International Academic Forum  
[www.iafor.org](http://www.iafor.org)

On the one hand, modern post-industrial information society gives people the opportunity to access the global information space, and on the other hand enlarge the gap between species *homo sapiens* represents. As famous German philosopher Friedrich Nietzsche says: «I do not run from people proximity: just the distance, the age-old distance which runs between men, drives me to the loneliness». Loneliness is one of the key existential problems in modern man being, to which psychology just getting close. It is an especially important issue in the age of globalization. Everywhere in the world the value experience of loneliness, which is not of less importance for the spiritual formation of man than authentic communication and social contacts, is leveled. You could even say that loneliness is a kind of psychological contribution to preserve the integrity of personality – after all in the presence of loneliness the opportunity of intimacy is almost absent. «Mad» society (Michel Foucault) generates «mad» people, so modern man in order to save himself, his integrity, his mental and psychological health, has to go into loneliness, plunging into his nobody dissolvable (Soren Kierkegaard) fundamentally inner life. It can be concluded that loneliness is a way to protect oneself in this spontaneous and chaotic changing world, the possibility to obtain value-notional guiding lines, some starting «sense-creation» matrix, which is not possible in «mad» society.

Loneliness as a typical *anthropic* characteristic of human being, is always seen as multileveled and many-sided phenomenon. Different typologies subdivide loneliness into components according to the characteristics of the subject (age, level of maturity, features of experience, perception, etc.). The typology of William Sadler and Thomas Johnson, presented in their joint paper «From Loneliness to *Anomia*» [3] is interesting. The researchers separate four measuring of loneliness out:

1. From interpersonal point of view the object is concrete people who are significant to individual, some referential group, rejection or avoidance that leads to the loneliness experience in this measuring.

2. The social measuring of loneliness arises, primarily, in condition of social isolation or public ostracism. The reasons are alienation, aversion, imprisonment, hospice, pension, resignation, fragmentation of society, a high degree of mobility, uncertainty or disintegration of traditional groups and the short life of groups. A sense of social isolation is often mixed with doubt, the striving to belong to certain integrity, anxiety about social identity and meaning of everyday confrontations with other people.

3. Cultural: a typical feature of this measuring - feeling of tearing their own culture off, its heritage, nostalgia, disunity with traditional meanings, values and guidelines. The cause of this measuring origin can be immigration, deportation, rapid social changes, revolutions, exile, failed youth's attempting of identifying with their own culture.

4. Space: for this type the feeling of disunity of me and isolation from being, nature, the cosmos and God is typical. It can be peculiar to individuals and to the whole nations and epochs as well. Its reflections are religious existentialism, in which man understands as a lonely restless soul, and Eastern philosophy.

We suppose that all typologies of the phenomenon of loneliness, including this one, can be generalized into two types - the loneliness as a conscious choice (anthropotypical characteristic of a human), and loneliness as a detachment, the impossibility of being-in-the-world (Martin Heidegger). In other words, people may be able in loneliness voluntarily or forcibly. The methodological basis of this

generalizing is the paradigm of subjectivity (S. Rubinstein, K. A. Abulhanova-Slavskaja, A. V. Brushlinskii, V. V. Znakov), which has just mastered and formed in psychology. According to this position, in both cases, *thrust* was on the man, his subjective experiences, his deliberate choice, his will and personal freedom made. This interpretation was *excellently* illustrated by the expression of Nietzsche, who writes that there are two kinds of loneliness. For one, loneliness - it is an escape of sick person, for another - an escape from the sick. The great philosopher probably experienced both kinds of loneliness - primarily the second, and then, unfortunately, the first.

We can assume that in the present there are no higher measuring of loneliness - social, cultural, space, and there is only an interpersonal level. It does not carry deep existential feelings and is temporary and situational. In general, the examination of interpersonal loneliness (loneliness «by roles») is a tribute to the classic paradigm by itself, as there is an identification of a human with the personality (not only the recognition of the personality just as «social role» of a human). In post non-classical paradigm interpersonal loneliness it is enough formal phenomenon.

The state of cosmic loneliness, which includes a layer of everyday experiences and has a permanent (timeless) and super situational nature, possesses the great potential for psychotherapy. At this level, a man is able to rise above himself and the whole world in the sense of that he has the opportunity to see the reality on the other side, abstract from it.

Despite the fact that for many people the notion of loneliness carries negative cultural connotations, its experiencing is an essential component of a modern man being. Voluntary loneliness assumes going away from society to itself, forced loneliness also takes one away from people, but not to itself, as commonly thought, but from itself. Therefore, there is a burning issue about lack of auto communication. A man cannot be alone with himself because of the overall social influence and ubiquity penetration of civilization in our lives. The scale and availability of different communication channels make the communicating superficial. O. V. Lukyanov names modern culture «the culture of loneliness» and he writes that when quantity of means of communication grows, the deficit of communication's meaning grows too. [4] Man is as if in zero-gravity: on the one hand there is the lack of meaningful social contacts, and on the other hand - the lack of autocommunication. Viktor Frankl called this state existential vacuum. [5]

In this connection, no less important issue is empathy. After all, the ability to arbitrarily «penetrate» to the emotional world of another person is the foundation of balanced relationships, and balanced relationships with the outside world permit to organize contacts with oneself, open up new horizons, to make the oneself phenomenological world deeper, richer and full.

The term «empathy» came to scientific psychology in the early twentieth century, but in the Russian psychology was injected only in the early 70's by T. P. Gavrilova. She affirms that the empathy recognized by Wilhelm Dilthey and his followers as the main method of the spirits sciences as «understanding» sciences opposed to rational explanation in the natural sciences which are «explanatory» sciences. [6]

There are many different definitions. Anna Freud gives the following: «Empathy - is the understanding of emotional state, entering into feelings of another man, the ability to feel himself in his place; implies that a person, feeling themselves the object, continues to recognize their own identity». [7] Empathy is a complex process, the essence of which is a comprehension of the inner world of another man. Carl Rogers (1975) wrote: «The state of empathy, or being empathic, is to perceive the internal frame of reference of another with accuracy and with the emotional components and meanings which pertain thereto as if one were the person, but without ever losing the «as if» condition. Thus, it means to sense the hurt or the pleasure of another as he senses it and to perceive the causes thereof as he perceives them, but without ever losing the recognition that it is *as if* I were hurt or pleased and so forth. If this «as if» quality is lost then the state is one of identification». [8]

Empathic comprehension, when the therapist transmits the perceived content to the client, considered by Rogers is the third most important condition of a person-centered therapy, closely interconnected with the others two – authenticity and congruence. Empathy does not imply appraisal, blaming for attempts to open unconscious feelings, since they can be traumatic. Empathetic person, pointing to the possible meanings of the Other's feelings, helps him experience them more fully and structurally. Being with Other means to lay for some time your own viewpoints and values aside, to enter into his world without any bias. This means that empathetic person remains with himself.

We postulate that empathy is not a natural gift, which is either given by birth or not. It can be developed, at that understanding the responsibility that we take. Lack of control over the ability of emotional feeling Other's world can be fatal to both sides.

If we turn to the sources, we can say that the feeling of loneliness originate from the ability of the human mind to divide the world into its constituents, to differentiate it and make a choice (like or dislike). But child is born without a personal identity. He does not even have the ability to feel his own body apart from the world, mother, and separate the I and not the I. Later, under the pressure of social norms and contracts he learns the need of selfish opposition to all the rest, and dips into the disintegration area. That is the person divides communication partners on their's own and others, near and far, necessary and unnecessary people. This separation in the end generates loneliness. Empathy allows to take the Other's loneliness as an existential given preserving the immunity of borders of his personality. According to Karl Rogers [9], empathy may include not only understanding of Other's feelings, but also an emotional response to them, a kind of feedback, which implies the involvement and supportiveness.

Empathic «penetration» into emotions and feelings of Other helps to draw a conclusion about its semantic fullness, values and content. It relates to the content of the experience of loneliness as well. Loneliness and empathy can be considered as two opposite phenomenon. Loneliness in fact, is the lack of a sense of connectedness with the world and people. Through empathy, in contrast, deep, personal-colored connection with Other is built.

Empathetic person can conclude has the experience of loneliness constructive or destructive function, is it lawfully to interfere in the internal world of the Other, or he



knowingly and with full realization of his/her decision move away from society? Understanding feelings of Other should be based on knowing of their own responsibility and developed sense of morality: empathy does not give the moral right to interfere in anyone's internal world, even with the positive intention, since feelings and their causes can be interpreted wrongly, mistakenly, and the invasion can bring harm.

However, if the state of loneliness is destructive and associated in the people minds with «throwing out», needlessness, isolation, negative experiences, a possible solution is trying of empathic sensation with him. And the experience of mutual (two-sided) empathy permits to reduce the destructive effects of forced loneliness, to realize the unity, synergism, continuity of immanent relations among people. In this case, empathy has great semantic, synergistic and psychotherapeutic potential.

V. I. Kabrin understands a man as a complex constellation of communicative worlds and postulates communicative essence of life. The meaning of their being a man gain in a process of discovery and creation of their own ways of communication with others, with the world and with himself. [10] In this case, the destructive loneliness can be compared with communicative stress, which containing the «experience of existential anxiety,» and the creative loneliness with the communicative trance, «experience of existential determination». Exactly here arise an area of autokommunication or metacommunication (by V. I. Kabrin). In other words, man's metaphorical level can be so high that he/she is able to get communicative trans from loneliness.

It is logical to assume, that going into transcommunication area, as «united eidetic semantic space of meeting» (V. I. Kabrin) is possible only through the experience of loneliness and empathy. *Irvin* Yalom note exactly the meeting with loneliness as a necessary condition of a deep and sensible involvement in the Other. Experiences of higher loneliness, cosmic measuring of it, its transcendence brings a man to a fundamentally new level of being - the level of universal cosmic unity experience. Speaking in mystics terms, to feel the unity with the cosmos, one must experience the feeling of despair and isolation (as a symbolic ritual of «inner fire» cleaning), that is only overcome all the stages of loneliness, one can exceed it, into a state of Other's empathic feeling.

«A man must carry his inner growth out by himself, but how?» - asks V. V. Nalimov, noting that «we live in the internal space less than in the external» [11, p. 77]. Anomalous communicative trans (when by Kabrin «loosing of interpersonal skill as a semantic attitude to the world and to itself» occurs [11]) in terms by V. V. Nalimov can be considered as *hyper personality* when as a result of avoiding feelings of loneliness at the interpersonal level may appear «correlative connectedness of semantic similarly oriented individuals», that is «thoughtless behavior of the excited crowd,» [11, p. 81]. This communicative anomaly or pseudo attitude with another person replacing autokommunication (or, according to V. I. Kabrin, metacommunication as a dialogue with yourself about the «how, why, why,» etc.), is only a rough pretentious imitation of an original transcommunication. If over a man prevailed extroverted desires and aspirations, he searches for the senses in the outside world, without appealing to the spiritual world, which located inside. Neurotic aspiration for searching and appropriation things of the material world, imposing to us

by the consumer society, only become stronger if it comply with. It will never be blase, since the objects of desire are limited and relative. While resorting inwards leads to absolute, limited senses.

However, the concept of *hyper personality* one can allotted with constructive potential if it was created by empathy. People with a common semantic field are doing as one organism (just the organism, but not the mechanism, since we are dealing with such its properties as synergy and emergence).

The idea of the research project was born in the state pension organization where there psychologist watched different nuances in officials attitude to older people, who are suffered from loneliness as a result of retirement.

As the hypotheses of the research several assumptions were adduced. First, people, who show great capacity for empathy, are less subjects to the destructive effects of loneliness. In other words, higher the development of human capacity for empathy is, lesser he/she feels the destructive loneliness. Second, people who experience a destructive feeling of loneliness, less disposed towards the empathy to others. That is, if loneliness is not perceived as a resource and space for self-reflectiveness, empathy cannot be highly developed, as a person who has no experience of «self-absorbing», are more likely incapable of «plunging» into the Other.

It is planed that the research will realized in two stages. In the first stage psychological diagnostics of state pension organization's staff using test tools will be conducted. In the second stage, based on the obtained information, will be made an attempt to create a model of teaching training oriented to the development of empathy and overcoming the destructive effects of loneliness.

When examining the intercommunication of phenomenon of loneliness and empathy will use the following methods: 1) The inquirer «Diagnostics of the level of polycommunicative empathy» (I. M. Yusupov, 2002). 2) The methodology «Diagnostics of empathy level» (V. V. Boiko, 2001). 3) The inquirer for the diagnostics of ability for empathy (A. Mehrabien and N. Epstein, 1996). 4) Differential inquirer of loneliness experience (D. A. Leontiev, E. N. Osin, 2010).5) Diagnostic inquirer «Loneliness» (S. G. Korchagina, 2008). 6) The inquirer for determination of the kind of loneliness (S. G. Korchagina, 2008). 7) The methodology of diagnostics the level of subjective experience of loneliness (D. Russell and M. Ferguson, 1989). Also for receiving of the semantic field of feelings concerning empathic experience and states of loneliness planned to use texts of reflexive essays and interviews.

Research's result allowed realizing psychological help for the development of empathy of social service workers in the context of a combined behavioral and existential-humanistic knowledge. To achieve this goal creating of practical tools to *accompany those who* works with retirees, experiencing loneliness. One of the factors of modern culture is the intolerance to this feeling. This explains the growing popularity of communication trainings. D.A. Leontev said in an interview in «Psychologies» (№ 10, 2006): «In my opinion, loneliness trainings are much more important than communicative learning» [12]. Different trainings, as well as other forms of psychological and psychoeducational service, oriented at formation of a

balanced and deliberate understanding of the loneliness experience, as a personal resource, allows participants to take a fresh look at their life and to appreciate the value of the rich internal communication.

Post-industrial society, emphasizing the growing menace of anthropological crisis (V. S. Stepin), should pay close attention to the devaluation of the orthodox cultural values, which turns human being in an anomic world into continuous race for survival and for the preservation of the integrity of the one's own personality. Therefore, the theoretical and practical developmental work about loneliness and empathy phenomenon represent growing interest for the scientific psychological community. Considering the experience of loneliness and empathic experience as an inexhaustible personal resource for self-development and self-realization, we can talk about the heuristic and practical potential of this research. This research is able to contribute to forming an integral understanding of loneliness phenomena and its intercommunication with human's emphatic abilities and become the basis for further theoretical and empirical researches.

#### References:

1. Kierkegaard S. Fear and Trembling; trans. by Isaeva N.V., Isaeva S.A. Moscow: Respublika, 1993 (in Russian)
2. Foucault M. A History of Insanity in the Age of Reason; Ed. Levit S. Ya. Histoire de la folie a l'age classiqui. St. Petersburg : Universitetskaja kniga, 1997, 573 p. (in Russian)
3. Sadler W., Johnson T. From loneliness to anomia. Labyrinths of loneliness; Ed. and trans. by Pokrovski N. E. Moscow: Progress, 1989 (in Russian)
4. Luk'anov O.V., Karpunjkina T.N. The Present – the culture of loneliness. The Messenger of Tomsk State University, 2005, № 286, pp. 97-104 (in Russian)
5. Frankl V. The Doctor and The Soul; trans. by Boreev A.A. St. Petersburg: Yuventa, 1997 (in Russian)
6. Gavrilova T. P. The notion of empathy in foreign psychology. Psychology Questions, 1975. № 2. pp. 147-158 (in Russian)
7. Freud A. Theory and Practice of child Psychoanalysis. V. 2. Moscow: 1999 (in Russian)
8. Rogers C . Empatic: an unappreciated way of being. The Counseling Psychologist, 1975, V. 5, N 2, pp. 2-10.
9. Rogers C. Client-Centered Therapy; Moscow: Refl-book; Kazan: Vakler, 1997, 320 p. (in Russian)
10. Kabrin V.I. Communicative World and transcommunicative potential of persons life: theory, methods, researches. Moscow: Smysl, 2005, 248 p. (in Russian)
11. Nalimov V.V. Searching of other meaning. Moscow: Progress, 1993, 280 p. (in Russian)
12. Leont'ev D.A. To love your Loneliness. Psychologies, №10, 2006 (in Russian)

*Seniors Use of Medical Electric Scooters with the Intention Satisfaction Study in  
Taiwan*

Win-Chin Lee\*<sup>1</sup>, Cheng-Hung Huang \*<sup>1</sup>, Chih-Fu Wu\*<sup>1</sup>, Yi-Jung Lee\*<sup>2</sup>

\*<sup>1</sup>Tatung University, Taiwan, \*<sup>2</sup>National Chiao Tung University, Taiwan

0203

The Asian Conference on Psychology & the Behavioral Sciences 2013

Official Conference Proceedings 2013

Abstract

This study aims to explore the properties of the senior citizens in Taiwan's living and their needs of going out. Through using the software "SPSS12.0" to build the model of this research to do confirmatory factor analysis, path analysis and satisfaction analysis, we can understand the influence caused by several dimensions on people's intention to go out by medical electric scooters. It can also be used in the research of evaluating the elder's needs, necessity and satisfaction of going out by land. The results can be served as the reference for future development and implement of traffic management strategy and the design of quality assessment as well. Nowadays, medical electric scooters belong to medical assistive devices. However, there aren't any relative laws of the right of way and the complete constructions of barrier-free space. The government should attach more importance to this problem and strike a balance between the elder's needs for using medical electric scooters and the road traffic safety.

According to the overall analysis, the conclusions are as following: by the collection of relevant documents and the direct distribution of questionnaire survey, we find that there are five dimensions of the factors that will significantly influence the elder and the disabled's willingness to go out by medical electric scooters. In the future, the government should give priority to the minority groups when legislating and create a safer environment for them.

**Keywords:** seniors, medical electric scooter, factor analysis, path analysis

## **1. Preface**

### **1.1 Background and motivation**

As Taiwan turns to be aging population society, the government puts more emphasis on senior's daily life same as America, Europe and other modern countries. After retirement, senior people still have many decades to live. If they don't develop their new interpersonal relationship, search for new society resources and enrich entity and necessity of life, it's easy to cause unhappy, not-adapt problems due to health decay and children's leave. With the urgency of senior's care problem, each government brings up with policy from different aspects such as economics, society and politics. They bring up solutions based on each problem from aging population to expect that senior get more understanding of themselves, develop their whole potential and raise their society value and life quality.

Taiwan is one of the most aging population country in the world, just minor than Japan in Asia region. Furthermore, these senior people from baby boom are not like the past of them who have little interest in social connect. They own fortune and quite large purchasing power. They are more active in social activities and business activities which create more commercial potential. Each enterprise brings up suitable merchandise and route to satisfy the requirement of aging people.

Medical electrical scooters solve the out-going problem and substantially increase mobility and feasibility of seniors. Electrical scooters indeed are quite popular among seniors. The amount of electric scooters raises up gradually because they are easy to operate and their smaller speed than other transportation's speed. Senior people don't have enough ability to response of chaos traffic which is obviously lower than general drivers. Furthermore, medical electric scooters belong to medical assistive devices nowadays. However, there aren't any relative laws of the right of way and the complete constructions of barrier-free space. . The government should give priority to the minority groups when legislating and create a safer environment for them.

### **1.2 Research intention**

- (1) This research explores elders in Taiwan area and their everyday transport needs.
- (2) An electric powered scooter satisfactory survey is used as the reference for the electric scooters quality requirement.
- (3) Provided Ministry of transportation and communications with elder's view towards traffic laws so that safety measures and precautions can be planned.



### **1.3 Methodology**

(1) Establish research topic (2) Establish the research motivation and intention (3) Research and collect documents (4) Design and revise questionnaires (5) Execute questionnaires (6) Collect and process questionnaire data (7) Analyze and review the data (8) Conclude and make suggestions

## **2. Reference review**

### **2.1 The definition of the elderly**

At Taiwan's current rate of aging, it takes 22 years to increase the senior (over 65) population by 10% to 20%. Other countries like Sweden, America, Denmark, England and Japan have rates of about 85, 70, 61, 50, 24 years respectively. Taiwan has the highest rate of aging among other countries. There will be 29.8% of people above 65 years old in 2051 (Executive Yuan for Economic Planning and Development, 2008). The existing welfare laws set up "people above 70 years old are the main body to enjoy welfare of old people's welfare." Official insurance laws prescribe that 65 is the right age to force them to retire. The labor insurance laws order that people up to 55 years old can apply for the elderly pension. And in general, indexes are used to measure the degree of population aging in demography such as the elderly population index, the aging index, Dependent population index which all use the age of 65 as the calculating standard.

Due to different grow-up background, culture background, living environment, personal character and interaction with family, emotion condition of elders would be obviously different. However, while people mentally and physically decay, people tend to have same mode as followings:

- (1) opposite response
- (2) feelings of empty and loneliness
- (3) response to emotion gets lower obviously
- (4) lack of thinking
- (5) easy to be affected by environment or others

Elders face the change of living type, such as retirement which would make entire life filled with problems such as aging decay, birth, death, loss of couple, smaller living circle.

Elders have large heterogeneity in the aspect of physiology, cognition and social relation. Development in each age has its own property. Therefore, it's necessary to



put more emphasis on heterogeneity. Realize elder's requirement of degree and type and evaluate in particular.

### **3. Architecture and Methods of Study**

#### **3.1 Architecture of Study**

Learn the factors for affecting seniors' intention of going out from questionnaire. The direction of this study is to know the current physical and mental status, the potential awareness and attitudes. Get know how to affect intention of going out and affect the actual outside behavior.

#### **3.2 Research model and hypothesis**

To analyze the reason for the electric powered scooters user's intention of going out, the whole research hypothesis is as following,

H1: The motivation of going out for using or purchasing the electric powered scooter has significant positive influence on the user's intention of going out.

H2: The current physical and mental condition of the user has a significant positive influence on the user's intention of going out.

H3: The interaction and support from family has significant positive influence on the user's intention of going out.

H4: The view of the external traffic environment has significant negative impact on the user's intention of going out.

H5: The satisfaction degree of using the electric powered scooter has significant positive influence on the user's intention of going out.

H6: The physical and mental conditions have a significant positive influence on the motivation of purchasing electric powered scooters.

H7: The physical and mental conditions have significant influence on the user's family interaction and support for going out.

H8: The external traffic environment has significant negative impact on family's support for him going out.

H9: The current situation of interaction with his family has significant positive influence on motivation of purchasing an electric powered scooter.

#### **3.3 Research instrument**

##### **(1) A questionnaire survey**

Conducting a questionnaire survey is determining the purpose of the study. An object of the study is defined as the electric powered scooters users who are over 65 years old in 13 townships of Taiwan. The questionnaire survey is designed to be 39 questions and 120 people are tested by pretest sample. The number of testers is

determined by that of questions (about 3 to 5 times). If the formal questionnaire survey sample is a regional study, it's more proper to keep the average number of samples at 500 to 1000 people. Limited by time, manpower, the cost and the large divergence of study object, I adopt the "Simple random sampling" method.

#### (2) The design of questionnaire

At the questionnaire design, Davis (1985) brought up the "Technology Acceptance Model (TAM)" in 1989. The main purposes of this model are explaining and predicting users' acceptances of information systems. TAM theoretical model develops two important beliefs of measuring the acceptance of technology which are "Perceived Usefulness (PU)" and "Perceives Ease of Use (PEOU)". A scholar Alpaugh considered that people who are over 65 years old must re-evaluate and concern more about personal health leisure, searching the meaning of life. Wilde (1982) raised "Risk Homeostasis Theory (RHT)". It supposes whether risk and risk-taking tendency balance can be the basis for making the own decision of taking adventure.

"Quebec User Evaluation of Satisfaction with Assistive Technology (QUEST)" is published in 1996 in Quebec by scholars Demers, Weiss-Lambroum and Ska. The foundation of theory integrates "Scherer's Matching Person and Technology Model, MPT (1989)" and Weiss-Lambrou's "Tridimensional paradigm (1993)". From those document, this study sorts in five dimensions as followings: The motive of using or purchasing electric powered scooters, current physical and mental conditions, current interaction with families, viewpoints toward the traffic environment and the satisfaction of using electric powered scooters.

### 3.4 Scale questionnaire, Pretest and Analysis

The questionnaire included 5 factor dimensions and 39 questions at the first design. Furthermore, we use Likert's five-point to score, item analysis, validity analysis (construct validity), reliability analysis. In the terms of item analysis, the pretest scale adopts CR to test and deletes the questions with low  $\alpha$  value to proceed item analysis. In terms of construct validity, the factor analysis proceeds namely after item analysis\_deletion some questions of the pretest scale analysis,. Subsequently, using principle component analysis and taking orthogonal axes to capture the factors when eigenvalues  $>1$ . At the basic assumptions test area, the value of KMO is 0.919, greater than 0.5 which shows that many common elements exist among variables. Therefore, it's suitable for using factor analysis. In Bartlett's spherical test, the value of  $\chi^2$  is 15400.528 ( $p < 0.01$ ) which achieves significant and indicates that there is a remarkable identical element between the study objects relevance matrix. Therefore, it

is suitable for using factor analysis, too. The reliability adopts the internal consistency coefficient, that is, calculating the total scale and the subscale by Cronbach  $\alpha$  coefficient. And its various sub-scales' Cronbach  $\alpha$  values range from 0.442~0.903, while the Cronbach  $\alpha$  value of the total scale is 0.943.

#### 3.4 The object of study

This study selects elders who are above 65 years old and using medical electric scooters as objects. Overall, there are 65 questionnaires. Except for 6 questionnaires which aren't qualified, there are 120 qualified questionnaires. The second edition questionnaires are 630 in total. After deleting improper questionnaires, there still remain 600 effective questionnaires.

### 4. Statistics and analysis of Survey results

#### 4.1 Satisfaction and ANOVA analysis

Most of the respondents average value 4.72~4.77 are satisfied with the electric powered scooters they use now. By the Pearson correlation coefficient, we can get know of the motivation of using electric powered scooters, the current physical or mental condition, the current interaction with family, the viewpoints of the traffic environment, the satisfaction of using electric powered scooters and which are all related to intention of going out. Except for the views to the traffic environment of seniors are negative relevant to other four dimensions, other four dimensions to each other are all positive relevant. To explore if there exists the specific relations between the intention using electric powered scooters and potential variables, the study adopts "Analysis of Variance (ANOVA)" this method to analyze and proceed statistics. First of all, in this regard of intention using electric powered scooters, the analysis result of ANOVA can be found 5 latent variables which have achieved statistic significance. It indicates that for senior citizens, the potential variables indeed exists significant difference in intention of going out. We can see data from table 1 to 4.

#### 4.2 Multiple Regression and Structural Equation Models

Adopt Multiple Regression and Structural Equation Models to test the conceptual architecture and hypothesis. To observe individual variable, the senior citizens have the highest ability to explain the view of traffic environment while the second of interaction with their family. As a result, 5 dimensions for going out intention of using electric powered scooters all present significant relations. Therefore, in regard to the motivation of using electric powered scooters, it considers that physical and mental conditions have greater influence than interaction with their families.

Collect foregoing data of Multiple Regression(Figure1) and we get that Structural Equation Models as follows:

- (1) In terms of this study's factor dimensions for explaining the intention of going out of using electric powered scooters, regression coefficient is 0.955.
- (2) Through surveying the results, there is direct significant influence between the physical and mental conditions and viewpoints to traffic environment. The physical and mental conditions can explain coefficient of regression which is 0.759 for interaction with family is. The traffic environment explains that coefficient of regression which is 0.820 for interaction with family. According to foregoing information, it indicates that the more disordered traffic environment is, the lower support from family is.
- (3) Through surveying the results, there is direct significant influence on the using electric scooters motivation to the physical and mental conditions and viewpoints to traffic environment. Physical and mental status of senior citizens explain coefficient of regression which is 0.749 for the motive of using electric scooters. After adjusting, the interaction with family explain coefficient of regression which is 0.684 for the motive of using those scooters. Although the external traffic environment for senior citizens is very dangerous, they still need to go out. Therefore, their requirement for scooters quality will be absolutely higher which has significant influence on going out intention. Kim (2004) also pointed out they may still have higher willing to use personal transportation under the physiological and psychological permission (Quan Lun, Xu, 2001). Physical and mental conditions, interaction with family and using motivation of five dimensions have also have effect directly significantly.

## **5. Conclusion and make suggestions**

### **5.1 Conclusions**

- (1) In this study, there are over 70% users living with their family who expect to use electric powered scooters to mitigate family's burdens. In independent-family circumstance, they can safely get around. Therefore, the motive of using or purchasing electric scooters is direct proportion to the going out intention. Shi An, Liang (2005) adopts David's (1989) "TAM" to research for the basis and discovers that personal view for electric scooters will be a positive effect of the using willing.
- (2) In this survey, the physical and mental status of users has the significant influence on intention of going out which is conformed to hypothesis "The behavior for physical and mental status (mentioning at chap 3.2)".
- (3) The survey of seniors in Nantou Country indicates that seniors living with their family account for 70.83%. Only on the circumstance of their good physical and mental condition can they get around alone with their family's support which is conformed to this hypothesis of study "(H3) The interaction and support from family has significant positive influence on the user's intention of going out."

(4) Homeostasis Theory (RHT) supposes whether risk and risk-taking tendency balance can be the basis for making the own decision of taking adventure. While senior citizens face the risky traffic environment, they intend to change their degree of attentiveness to environment. Through cautious behavior to reduce the risk, their intention of going out is negative relevant and significantly affected.

(5) Every average degree of question is above 3.5 in this study of “The satisfactory degree of using electric powered scooters”. “Do you know the policy of government’s pension for purchasing electric powered scooters?” got the highest points of satisfactory. “Prices of scooters are reasonable ” are the most unsatisfied item. It indicates that seniors in Taiwan care much for the price of the electric powered scooter.

## 5.2 Suggestion

For most seniors, medical electric scooters are the most convenient transportation. However, under such traffic condition, there is no-barrier space and complete construction. The government should attach more importance to no-barrier space and road only-for-electric scooters.

The reason for the increase of electric scooters’ requirement is a lot of time after elders retiring. According to this research, there are 60 percent people having middle-low income. We suggest government should modify the law of allowance to reduce the burden of minority groups.

Each driver should be familiar to traffic law and obey traffic sign. However, the data shows that there are approximately 57% people without any vehicle license. It indicates that elders might don’t make sense of every traffic law and sign. We suggest that related transportation officials should strengthen the guidance on law and safety, encourage they to take license exams and hold vehicle course regularly to enhance effect and build the correct concept of traffic safety.

## 6. Reference

1. Ming Long, Wu (2002) ,SPSS Statistic Applied Sampling, <http://www.kingsinfo.com.tw>
2. Tian Zhu, Qiu (2007) Social Gerontology, Lowen Publisher.
3. Guo Yan, Huang (1994) Aging Population Society, Ministry of Education.
4. Fen Yu, Zhu (1997) Retirement career planning of the elderly people, Shannon Light solemn 54.
5. Jin Tian (1998) Bound Random Integral Equations The existence and uniqueness ,

paper from Department of Bound Random Integral Equations The existence and uniqueness, Mathematics of National Center University

6. Si Jia, Zhong and Guo Yan, Huang (1987), A survey of life style and satisfaction of senior citizens.

7. Center for Measurement Standards, <http://www.cms.itr.org.tw>

8. Council for Economic Planning and Development of Taiwan (2008) population estimation in R.O.C. from 2002 to 2054, <http://www.cepd.gov.tw/people/index.htm>

9. Ying Zhen, Lin (2004), <http://www.fcu.edu.tw/~itra/trade/file/146.doc>

10. Davis, F. D., A Technology Acceptance Model for Empirically Testing New End-User Information Systems: Theory and Results, Doctoral Dissertation, 1985, MIT

11. Dion, P. A., Rajshekhar, J., & Dilorenzo-Aiss, J. (1998). An empirical assessment of the Zeithaml, Berry, and Parasuraman service expectations model. *The Service Industries Journal*, 18(4), 66-86

12. Fornell, C. (1992). A national customer satisfaction barometer: The Swedish experience. *Journal of Marketing Research*, 56(1), P6-21

13. OECD and Consulting Resources Corporation, 2003.

14. Scherer, M. J. (1991). *The Matching Person and Technology (MPT) Model (and assessment instruments)*. Rochester, NY: Author

## 8. Figures and Tables

Table 1 Valid analysis and reliability analysis

Scale	Cronbach's Alpha value	Subject to standardize project Cronbach's Alpha value	The number of items
The motive of using and purchasing electric powered scooters (MUPE)	0.442	0.515	7
The current physical and mental condition (CPMC)	0.451	0.496	7
The condition of interaction with families (CIF)	0.795	0.794	5
The views toward the traffic environment (VTE)	0.828	0.828	6
The satisfaction degree of using electric powered scooters (SDUE)	0.903	0.904	14
Total scale	0.943	0.946	39



Table 2 The Multiple regression test of the going out intention of using electric powered scooters

Model	R	R Square	Adjusted R Square	Std. Error of the Estimate	Standardized Coefficients (Beta)	T	Significance
The motive of using and purchasing electric powered scooters (MUPE)	0.785	0.616	0.711	6.53508	0.785	30.969	0.000***
The current physical and mental condition (CPMC)	0.870	0.757	0.757	5.11729	0.870	43.177	0.000***
The condition of interaction with families (CIF)	0.906	0.822	0.821	4.383887	0.906	52.479	0.000***
The views toward the traffic environment (VTE)	0.940	0.883	0.88	3.54442	0.940	67.339	0.000***
The satisfaction degree of using electric powered scooters (SDUE)	0.955	0.911	0.911	3.08944	0.955	78.470	0.000***

Table 3 The multiple regression of senior citizens' interaction with families

Model	R	R Square	Adjusted R Square	Std. Error of the Estimate	Standardized Coefficients (Beta)	t	Significance	VIF
The current physical and mental condition (CPMC)	0.759	0.576	0.575	1.12567	0.759	28.512	0.000***	1.000
The views toward the traffic environment (VTE)	0.824	0.680	0.679	0.97873	0.824	35.614	0.000***	1.000

Table 4 The multiple regression of the motive of using electric powered scooters

Model	R	R Square	Adjusted R Square	Std. Error of the Estimate	Standardized Coefficients (Beta)	t	significance
The current physical and mental condition (CPMC)	0.749	0.561	0.561	1.01902	0.749	27.667	0.000***
The condition of interaction with families (CIF)	0.684	0.468	0.467	1.12192	0.684	22.953	0.000***

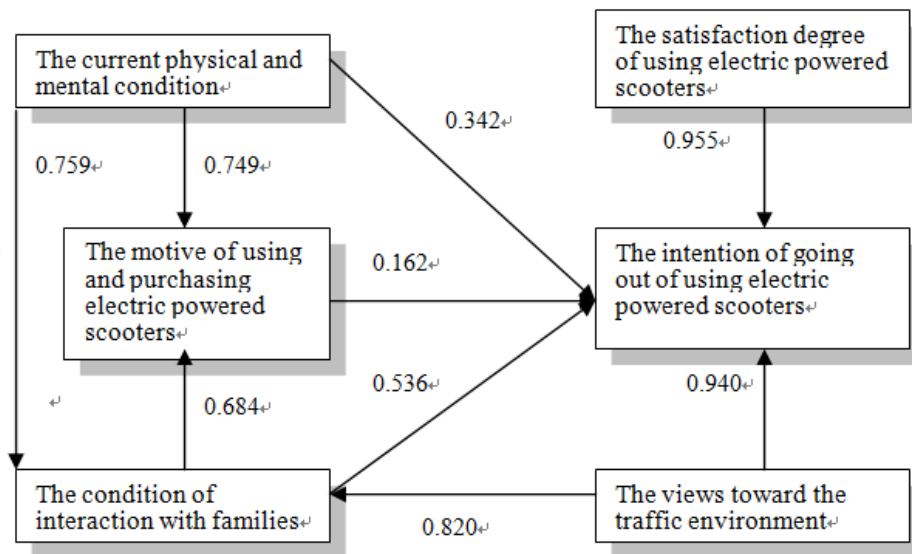

Figure1 Path analysis

iafor

*Examining Critical Success Factors for Medical Device Industry in Taiwan*

Ying-Jiun Hsieh, Hui-Ting Lin

National Chung Hsing University, Taiwan

0211

The Asian Conference on Psychology & the Behavioral Sciences 2013

Official Conference Proceedings 2013

Abstract

With the population aging, research indicated that the growing of chronic disease and rapidly increasing costs of healthcare become a burden worldwide. Global medical equipment market size in 2010 is 2,456 hundred million U.S. dollars. It is a big industry output. In a highly competitive market, how to create effective strategies and set successful marketing becomes a key issue. Although there exist few studies been completed on the critical success factors of medical device industry, these studies are all for one or several particular companies. This study aims to explore the critical success factors of the medical device industry in Taiwan.

The research population of this study was the customers within Taiwan. The study use survey research under different dimensions from customers' point of view such as price promotion, perceived quality, customer satisfaction and brand loyalty, etc., to identify the critical success factors of Medical Device Industry which have its own brand. The paper sent out 150 questionnaires in total. The survey returned 135 usable questionnaires; the response rate is 90%.

The paper found that corporate Image, cost / performance ratio, product quality, user Interface operation and service, customer-orientation are the critical success factors of medical device industry. Expectations through examining the critical success factors for medical device industry would achieve a better and deeper understanding of customers' needs, assisting establishing brand.

Keywords: Medical device industry, Critical Success Factors, Branding

## I. Introduction

### A. Research Background

#### 1. Aging Population

With the rapid economic and technology development, changes the mode of human life. The declining fertility in recent years, the fertility rate decrease from 5 children per woman to 2.5, and is predict to reach 2.2 in 2050. As the fewer children, the share of the population will rise naturally (Bloom, 2011).

The World Health Organization's proposed that active aging has become the core concept of the countries in the world for the elderly health policy formulation (Liu, 2007). With the population aging, the growing of chronic disease and rapidly increasing costs of healthcare become a burden worldwide. It needs new approaches for comprehensive population health management and healthcare service to meet these challenges (Shortell, 2010).

Villavicencio (2011) proposed that the healthcare services demand will rise dramatically (See as Figure 1). After adjustment for inflation, the costs of health care annual increased significantly from \$9,224 in 1992 to \$15,081 in 2006 among older Americans (Villavicencio, 2011).

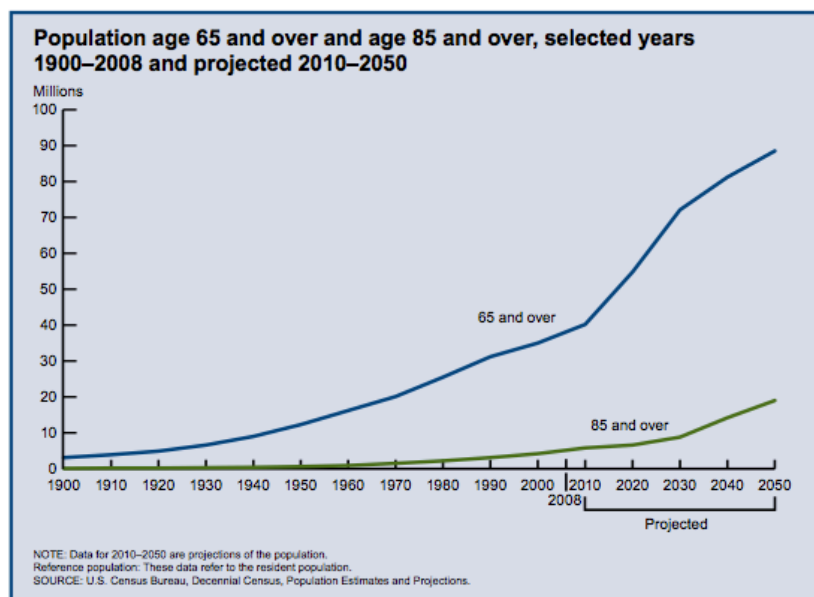

Figure1: The aging population

#### 2. Medical Device Industry

Global health care and medical accounts expenditure in recent years has increased noticeably. To reduce the medical cost and health care burden, the development of medical and tele-homecare equipment has been rapid growth. Global medical equipment market size in 2010 is 2,456 hundred million U.S. dollars. It is a big industry output (Industrial Technology Research Institute, 2012). PR Newswire (Reportlinker.com) announces that “The global medical device industry has experienced significant growth over the last five years and is expected to continue, reaching approximately US \$302 billion in 2017 with a CAGR of 6.1% during next six years (2011-2017). APAC is projected to lead the market and grow at the highest CAGR during the forecast period.”

Taiwan medical equipment market turnover in 2010 is approximately NT 66.2 billion, 2011 is approximately NT 72.1 billion. (Industrial Technology Research Institute, 2011). Taiwanese medical equipment companies have competitive advantages of flexible manufacturing process, cost management... etc., which are the important competitive in emerging markets; Taiwan is not only has the ability to do the research and development collaborations of medical equipment components, but also has experience with global marketing layout. The average annual growth rate in Taiwan medical equipment market was expected to reach 7.9% (2011-2015). Therefore, Taiwan medical equipment industry occupies an important position (PricewaterhouseCoopers, 2012).

Taiwan's domestic medical device Industry are more emphasis on low-risk in vitro diagnostic instruments, including electric scooter, blood pressure monitors, thermometers, contact lenses, blood glucose meter, blood glucose test strip, dialysis supplies, and other products. Among these technologies, the blood glucose meter and test strips are the largest part. (Ministry of Economic Affairs, 2010)

## B. Purpose of Research

With highly homogeneity product features and intense competition situation, if the companies are able to identify the critical success factors of products sales, the overall performance will continue to grow. It can significantly create high value and help Taiwan Medical Device Industry development. Therefore, this study through the industry analysis, secondary data collation to explore:

1. The environment of Medical Device Industry.



2. The critical success factors of buying Medical Device product from a consumer point of view.
3. The operation and development strategy as company's reference.

## II. Literature Review

### A. Critical Success Factors

To establish the core competence for medical device industry, the most important things is to examining critical success factors. Daniel (1961) has indicated that a business must manage the key success factors particularly well in order to be success. Hofer and Schendel (1978) noted the management of key success factors can influence through its decisions that and significantly affect the overall competitive positions of the various firms.

Rockart (1979) defined Critical Success Factors (CSFs, also called Key Successful factor) will ensure the successful competitive performance for the organizations. Aaker (1984) has suggested that a critical successful factor is an asset or skill that is needed to compete successfully. Successful firms are usually strong on several critical success factors. According to Kenichi (1985), the critical successful factor is a method used for strategic advantages identify. The firms should gain competitive advantages by concentrate resources in particular area.

Thompson and Strickland (2002) proposed the key success factors of an industry are related to product capital, competitive advantage, property, etc., which have a close relationship with net sales. Hence, a business could sustainability and gain consistent competitive advantages in an industry.

To Summarize Scholars definitions and opinions on the critical success factors, if the enterprise is able to obtain the critical success factors, it can take competitive advantage in the industry to achieve success. Therefore, the essence of critical success factors is that companies can obtain a competitive advantage in the industry, and increase operating performance.

### B. The Application of Critical Success Factors

The researches of critical success factors have been applied in different industries. Hong and Kim (2002) explored the root of such high failure rate from an “organizational fit of ERP” perspective, defining the ERP organizational fit concept, and examining ERP implementation impact with

contingencies. The results from 34 organizations by field survey showed that "ERP implementation success significantly depends on the organizational fit of ERP and certain implementation contingencies."

The survey of Cooper and Kleinschmidt (2003) shows the 10 performance metrics are reduced to two basic dimensions: program profitability and program impact. The research identifies nine constructs that drive performance. The main performance drivers the solid performers from: "a high-quality new product process", "adequate resources for new products", "strategic focus and synergy", "high-quality development teams", etc.

Chen (2004) based on the viewpoint of intellectual capital; systematically investigate the focus on key factor of banking enterprising finance. The study found that the rate of human resource capital value is the highest at 37.7%, the organization capital value are at 31.4%, the customer relationship value are at 30.9%. And the Banking industry is highly concerned on human resource capital value with 58.83%.

Lin (2008) divides two stages to implement the expert advice investigation, utilizes Delphi method to find key successful factors for documentary production in Taiwan. The study discovered in the above 12 key successful factor of record piece manufacture. The highest key success factor for the prospects is the "priority", next for the "enthusiasm", the third is "mission places", "the accomplishment of photographer" fourth, "the specialized ability" rank fifth. The findings may supply the documentary production personnel and the researcher to judgment the documentary success or failure.

With the retention rate of insurance agents getting lower and lower, the insurance companies faced with some impact such as the customer satisfactions decreasing, company resources waste, homogeneous competition, the pressure of institution and license requirements, etc. To confront the challenges which insurance agents face, Chen(2012) applied the Analytic Hierarchy Process (AHP) survey to conduct twelve key success factors of insurance agent performance such as: "Personal Characters" , "Organization Culture", "Success Motivation", "Supervisor Leadership", etc.

The research of key success factors in different industries summarized in the table 1:

Table 1: Research of critical success factors in different industries

Industry	Topic	Year	Author(s)
Enterprise resource planning (ERP) implementation	The critical success factors for ERP implementation: an organizational fit perspective	2002	Hong and Kim
New Product Development	Benchmarking the Firm's Critical Success Factors in New Product Development	2003	Cooper and Kleinschmidt
Corporate and Commercial Banking	The Study on The Key Success Factor about Intellectual Capital Formation of Corporate and Commercial Banking -- In Contrast with AHP and SJT	2004	Chen
Documentary Production	A Study of Key Success Factor for Documentary. Production in Taiwan.	2008	Lin
Insurance	Explore Key Success Factors of Insurance Agent Performance	2012	Chen

### C. Research of Critical Success Factors in Medical Device Industry

Wang (2003) identified the six critical successful factors such as "innovation ability", "web site business strategy", "the maturity of internal and external environments", etc.. Meanwhile, the study also found that there are several varies impacted the key factors of e-marketplace business successfulness like "the industry characters", "safety requirement", "technology intensity", etc. According to the industry characteristics, the critical successful factors are highly interrelated to the performance of e-marketplace. The companies can enhance performance and get succeed in biotech Industry by implementing e-marketplace.

Brown et al. (2008) focused on 68 responses of UK and Ireland medical device companies and proposed a new product development process in the medical devices industry. The result showed that the success factors influence new product development process improvement include: the financial analysis used throughout the developing process, the propagation of new product development priorities staff, and the involvement level of end users in development process... etc. The findings demonstrate the importance of the use of financial indicators, integration, and innovation to sustained successful product development.

Zenios et al. (2011) provided a taxonomy of the different roles that physicians play in device innovation, and identified which may not be well managed by today's institutions that the most susceptible to conflicts of interest. For better patient care, the study also provides recommendations on better manage

conflicts without physicians and companies' jeopardizing collaborate.

The research of critical success factors in medical device industry including several areas such as technical part, new product develop process improvement, medical service, the case study in particular countries or several particular companies, or the industrial development and industrial trend.

Although there exist studies been completed on the critical success factors of medical device industry, these studies are focus on the developing of medical device industry in global or particular countries or several particular companies. Some studies focus on the role of physicians in device innovation and medical service, some focus on the new product development process in different area. This study focus on the enterprise operation, try to find the critical factors for business strategies, aims to explore the critical success factors of the medical device industry in Taiwan.

### III. Research Methodology

The method to carry out this study was using a survey. The survey under different dimensions from customers' point of view such as price promotion, perceived quality, customer satisfaction and brand loyalty, etc., to identify the critical success factors of Medical Device Industry which have its own brand. The main steps of in this study are as follows:

1. Collect medical equipment information and secondary data, to understand the market characteristics and overview.
2. Review the literature of medical equipment industry and critical successful factor.
3. Establish the structure and scope of the study, design the questionnaire.
4. After the data collection, finally conduct the data analyzed.

This study reviews the literature of the medical equipment industrial characteristics, consumer behavior, and critical success factors; reference the variables from: Cheng (1998), Cheng (2000), Sun (2007), construct 20 variables of critical success factors for medical device industry from various scholars.

The subject was asked to fill out a questionnaire which elicited information concerning his attitude and motivation. The questionnaire includes two parts: the first part is to find the important considerations when consumer purchase and select the brand of glucometer, include 20 questions, and used a five point Likert scale to judge

the importance of each item in this research. The second part is personal information of respondents, include: gender, age, the highest degree, job, salary, and experience (ever bought any medical device).

Before the official release, the questionnaire have commissioned 5 SME employees in Taichung, adopted the recommended of staff, modifying the semantics which is unclear or use unknown words. The research population of this study was including: teaching and administrative staff in Taichung and Miao-li, executive master of business administration students in National Chung Hsing University, private enterprise employees in Taichung, and community people. The paper sent out 170 questionnaires in total. The survey returned 141 usable questionnaires; the response rate is 82%.

#### IV. Results

The analysis used the SPSS statistical software package, do the exploratory factor analysis (EFA). First, the descriptive statistics were computed. Next, reliability as a measure of internal consistency was calculated. The Kaiser-Meyer-Olkin (KMO) measure of sampling adequacy was .852 ( $>0.8$ ), the significance of Bartlett's sphericity test was .000; the result is suitable to do the exploratory factor analysis (EFA). The explanation capability is 68.857%. After Varimax method, the meaning of the various factors is more obvious and easier to interpret. The result shows that there are five factors.

The study names the five factors as: corporate Image, cost / performance ratio, user Interface Operation and service, Customer-orientation, Product quality.

#### V. Discussion and Conclusions

##### A. Factor one: corporate image

Corporate image are significant and indirect impact on customer loyalty, which is driven by both corporate and the image disconfirmation of expectations (Andreassen and Lindestad, 1998). The purchase intention can be influence by customer's familiarity and recognition of the products, and the enterprise functional, social, and perceptual image (Hsu, 2011).

Gray and Balmer (1988) proposed a pragmatic operational model (see Fig. 2). The model proposes the fundamental components of the process are including corporate identity, communication, image and reputation. It traces the

interrelationships amongst the components and indicates the feedback and correction are essential factors to the efficacy of the process. The Corporate identity is the reality of the enterprise. It refers to the distinct characteristics of the organization or what the organization is. To management the corporate identity, involves the dynamic interplay amongst the business strategy, corporate culture, the philosophy of its key employees, and organizational design. In the sensitive business milieu today, the strategic advantage and ultimate survival may well depend on corporate reputation. If enterprises can build good corporate image, it main have competitive advantage in the industry.

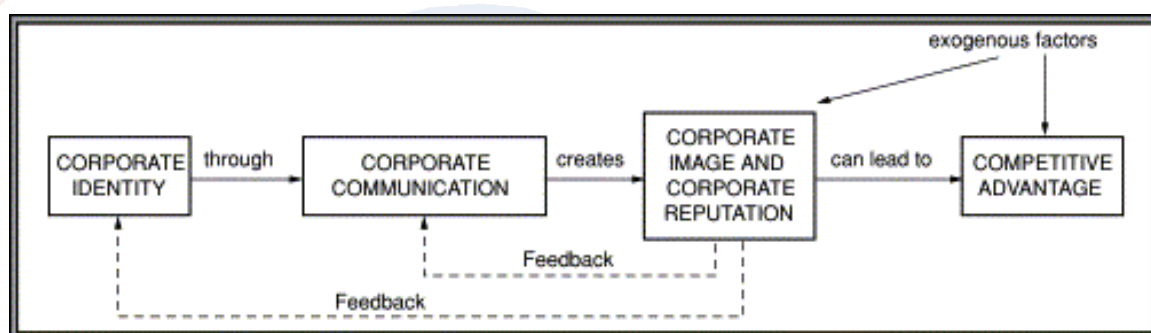

Figure 2: Pragmatic operational model

B. Factor two: cost / performance ratio

Elizabeth (2012) indicated the essentially four major outcomes possible when determining cost-performance ratio in figure 3, proposed that the cost-performance can also be used to analyze trends in production, and help buyers with making purchasing decisions. The most desirable outcome is area "C" that the item is low cost, but high performance. In the middle of the scale are area "A" and "D" that either high performance and high cost, or low performance and low cost. The least desirable ranking is area "B" which tends to be for a product that is high cost, but low performance.



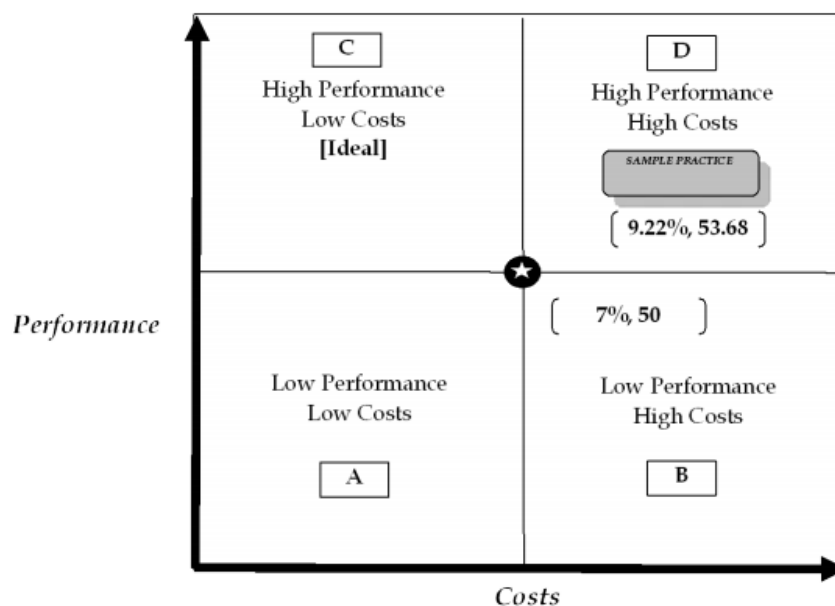

Figure 3: Cost Performance Ratio

To increase the sale of the products, the enterprises should provide valuable quality or service to the customer, which are low cost, but high performance.

#### C. Factor three: product quality

The product quality and the service quality variables influence customers' evaluation. (Sang and Eze, 2012) Enterprises need to maintain or upgrade their product and service quality measurement, be able to attract and retain customers as changes in the business environment. Also, the influence of new technology development becomes more pervasive in this 21st century (Sang and Eze, 2012).

For product quality control, firms can through several methods and tools such as: Total Quality Management-TQM (Docstoc, 2011), Quality Management System (Siliconware Precision Industries Co., Ltd.), Six Sigma method (Huang and Syun, 2012), ISO 9000, ISO 9001(Lin, 2011), ISO 14001(Iñaki and Boiral, 2013), etc.

The quality improvement strategy is related to customer perceptions, satisfaction and decides where changes in organization's services will improve its competitiveness (Lee and Burns, 1990). If enterprises can provide enough quality, it can directly influence customers' evaluation, create better corporate identity, and also, make a long-term relationship with their customers.

#### D. Factor four: user interface operation and service

The users of medical device products are community people. The interface design should also consider the different ages especially the elderly populations.

Lin and Yang (2006) research in developed home environment e-related home appliances designed for the elderly populations, and home environment lighting system operation interface, the operating using of convenience, compatibility, and adaptability. The results shows that language-based, graphical, and automatic creation interfaces and Interface icons (should be clearly identification) are important factors of operation.

Chou (2008) investigates the current difficulty and differentia of the ATM (Automatic Teller Machine) usage of young-adult and middle-aged users, and examines the universal design of ATM interface. The research concludes that: the middle-aged users prefer round keystroke on “Keystroke Design” and the keystrokes should be concentrated in an area with same shape. On “Page Allocation”, the background shall be as simple as possible, and preferred to use blue background with yellow or white font; in order to enhance the readability, the font of titles and important contents should be in size 36 or above; etc.

For service, the most likely sources of service improvement are better and management extra resources. Clear and quantified strategic priorities can lead to better organizational outcomes (Boyne, 2003)

In this study, the scores of user Interface item from the respondents is pretty high. The design of the Interface may directly influence the purchase intention. The enterprises should view it as an important consideration during the new product develops process.

#### E. Factor five: customer-orientation

Customer satisfaction measurement is a relatively new concept for many companies. Enterprises now recognize that new global economy has changed things forever (Cacioppo, Metronic). With the increased competition, crowded markets with small product differentiation and continual sales growth rate followed by two decades of the flattened sales curves have indicated that their focus must change (Cacioppo, Metronic).

The firms' choices and decisions related to customers' needs and preferences (Sang and Eze, 2012). It directly related to customers' evaluations of

employee service performance, physical goods, and services capes (Brady and Cronin, 2001). Ramendra (2012) suggest that salesperson's customer orientation has six domain areas which include: "providing information to customers", "understanding customer needs", "fulfilling customer needs", "creating and delivering customer value", "sustaining customer satisfaction", and "maintaining long-term relationships with customers" (see Fig. 4).

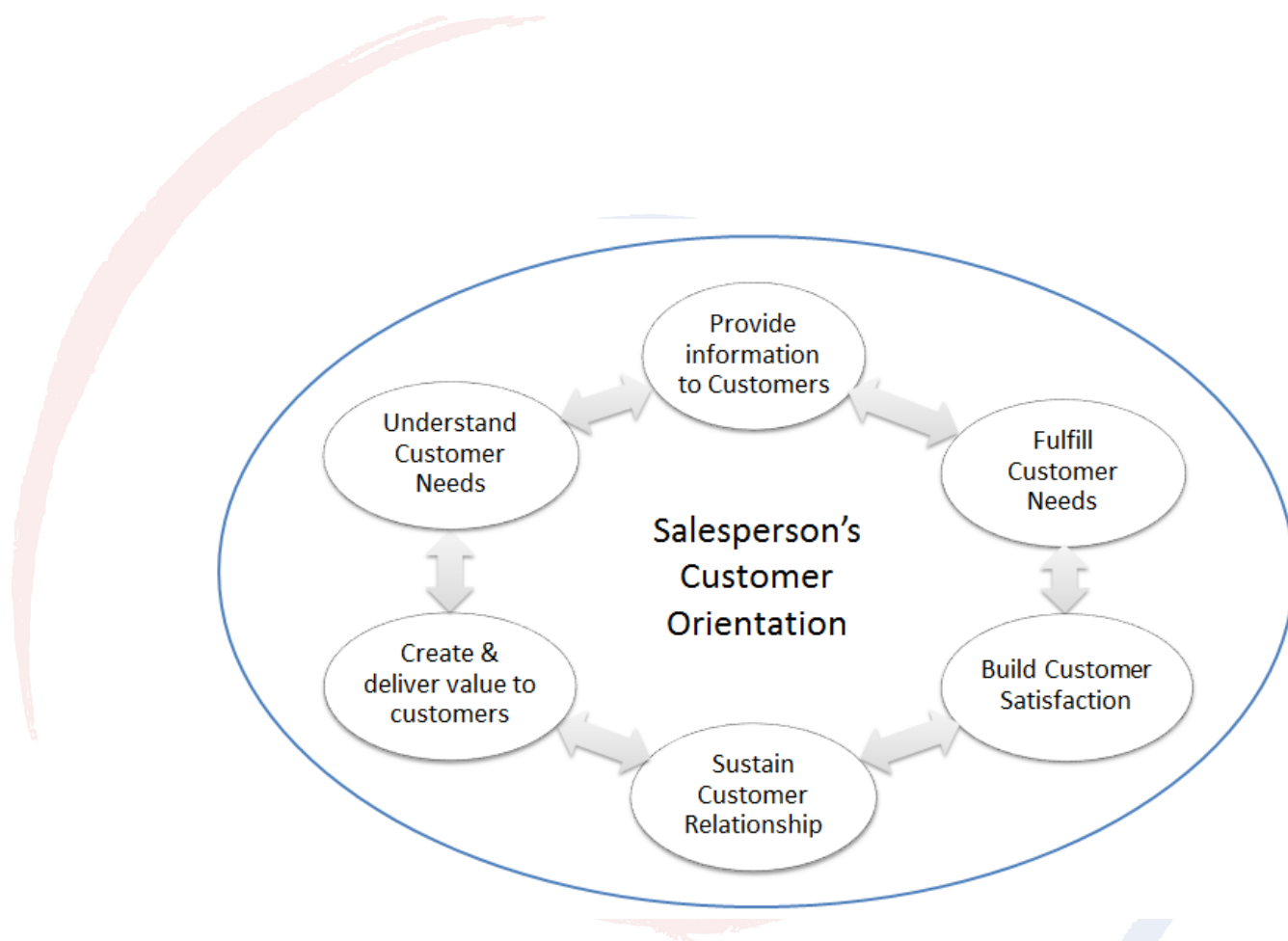

Figure 4: Salesperson's customer orientation has six domain areas

The sales managers can now apply specifically of the customer-oriented selling in six domain areas, and understand which conditions under particular domain area are important for customers. The study clearly explicates that defining customer-oriented selling in the changed world (Singh, 2012). If the enterprises focus on customer-orientation, it may create better customer satisfaction and maintain better sales.

#### F. Conclusions

To identify the critical success factors of Medical Device Industry which have

its own brand, the company should stand on the customers' point of view. The five critical successful factors are: corporate Image, cost / performance ratio, product quality, user Interface operation and service, customer-orientation. The findings expect to achieve a better and deeper understanding of customers' needs, assisting establishing brand.

## VI. Limitations of the Study and Recommendations for Future Research

For Future Research, the study expects to expand the scope of subjects. Search for the potential customers of medical equipment products, and find the successful strategy for setting up a new medical equipment brand.

Although the study has identified five critical successful factors of medical device industry, the limitation is that the brand established is a difficult task. Customers' rely on exist bland and exist products. Many companies used to spend highly cost on marketing such as advertisement, TV commercial, or other promotions (same in other industries). How to reduce the cost of marketing in medical device industry can be deeper research in the future.

iafor

References :

- Aaker D. A. (1984). Strategic Market Management, New York: John Wiley & Sons Inc., Page(s):24-70.
- Andreassen T. W. and Lindestad B. (1998). The Effect of Corporate Image in the Formation of Customer Loyalty
- Bloom D. E.; Boersch-Supan A.; McGee P.; Seike A. (2011). Population Aging: Facts, Challenges, and Responses, Program on the Global Demography of Aging
- Brown, A.; Dixon, D.; Eatock, J.; Meenan, B.J.; Young, T. (2008). A survey of success factors in New Product Development in the medical devices industry, Engineering Management Conference, 2008. IEMC Europe 2008. IEEE International, Page(s): 1-5
- Boyne G. A. (2003). Sources of Public Service Improvement: A Critical Review and Research Agenda
- Brady M. K. and Cronin Jr. J. J. (2001). Customer Orientation Effects on Customer Service Perceptions and Outcome Behaviors
- Cacioppo K. Measuring and Managing Customer Satisfaction, [Online] Available from: <http://www.qualitydigest.com/sept00/html/satisfaction.html>
- Cheng W.S. (2004). The Study on the Key Success Factor about Intellectual Capital Formation of Corporate and Commercial Banking-- In Contrast with AHP and SJT
- Chou P. C. (2008). The Research of ATM Interface Design for Middle-Aged from the Universal Design
- Cooper R. G. and Kleinschmidt E. J. (2003). Benchmarking the Firm's Critical Success Factors in New Product Development, Journal of Product Innovation Management, Volume 12, Issue 5, November 1995, Page(s): 374-391
- Daniel D. R. (1961). Management Information Crisis, Harvard Business Review, Vol.39 (5), and Page: 111-116.
- Docstoc (2011), [Online] Available from: <http://www.docstoc.com/docs/38643851/TOTAL-QUALITY-MANAGEMENT---TQM>
- Elizabeth W., MBA, FACMPE, CPC 2012, [Online] Available from: <http://www.elizabethwoodcock.com/resources/TOOLS%20+%20cost%20performance%20ratio%20for%20billing%20office.pdf>
- Gray E. R. and Balmer J. M.T. (1988). Managers needs to understand their firm's corporate identity and corporate communications, and the interrelationships amongst these components, Managing Corporate Image and Corporate Reputation
- Hofer C. W. and Schendel D. E. (1978). Strategy formulation: Analytical Concept,

- West Publishing Company, St Paul, Minn (as cited in Leidecker and Bruno, 1984)
- Hong K.K. and Kim Y. G. (2002). The critical success factors for ERP implementation: an organizational fit perspective, *Information & Management*, Volume 40, Issue 1, and [Online] Available from: 25-40
- Hsu C. Y. (2011). The Influence of Corporate Image and Product Labeling on Purchase Intention: Using Consumer's Energy-saving Knowledge as Moderating Variable
- Huang C. J. and Syun S. Y. (2012). An Investigation on Introducing Six Sigma Method to Production Manufacturing Process Improvement  
Industrial Technology Research Institute (2011), [Online] Available from: <http://www.itri.org.tw/chi/publication/publication-content.asp?ArticleNBR=3731&p=3>
- Iñaki H. S. and Boiral O. (2013), ISO 9001 and ISO 14001: Towards a Research Agenda on Management System Standard
- Kenichi O. (1987). The wisdom of strategists. (H. Y. Huang, Trans.). Taipei: Chang he Press. (Original work published 1985)
- Lee R. B. and Burns L. R. (1990). The service quality improvement strategy: identifying priorities for change, MCB UP Ltd
- Lin J. Y. and Yang Z. S. (2006). The study of Interface of Compatibility of E-Products for the Aged People in the Living Environment
- Lin C. C. (2008). A Study of Key Success Factor for Documentary Production in Taiwan  
Chen T. C. (2012). Explore Key Success Factors of Insurance Agent Performance
- Ministry of Economic Affairs (2010), Critical success factors for implementing knowledge management in small and medium enterprises
- PR Newswire, Global Medical Device Industry 2012-2017: Trend, Profit, and Forecast Analysis, [Online] Available from: <http://www.prnewswire.com/>
- Rockart J. F. (1979). Chief executive define their owns data needs, *Harvard Business Review*, Vol. 57, No. 2, pp. 81-93.
- Sang Q. A. and Eze U. C. (2012). Assessing key factors in consumers' evaluation of product and service quality, *International Journal of Innovation and Learning*, 2012 Vol.11, No.4, Page(s):415 – 435
- Shortell S. M. (2010). PhD, M.B.A., M.P.H, Robin Gillies, PhD, Frances Wu, BS, MS, United States
- Siliconware Precision Industries Co., Ltd., [Online] Available from: [http://www.spil.com.tw/services/?u=4\\*0](http://www.spil.com.tw/services/?u=4*0)
- Singh R. (2012). A new conceptualization of salesperson's customer orientation:



### Propositions and implications

Sun C. P. (2007). The Key Success Factors of Business Development for Foreign Medical Supply Enterprises in Taiwan

Thompson, A. and Strickland, A. J. (2002). Strategic Management Concept and Cases, 13th ed., New York : McGraw-Hill.

Villavicencio F. (2011). Identity in Healthcare: A Diet for 2011 and Beyond, Page(s): 1 of 3

Zenios S.; Burns L.; Denend L. (2011). The Role of Physicians in Device Innovation: Critical Success Factor or Conflict of Interest? Stanford University

王居卿 (2003), 臺灣生技醫藥健康口業推動電子市集的關鍵成功因素研究, 電子商務研究, 第一卷, 第一期, 頁 41-66

林嘉莉/Lin C. L. (2011). ISO 9001 電子化文件管理系統之建置—以某中資公司為例, 國立中央大學碩士論文

張紹勳 (2000), 網際網路行銷之成功模式, 中華管理評論, 第 3 卷第 2 期, 頁 17-38

經濟部工業局/Industrial Technology Research Institute (2011), 2006~2011 年台灣醫療器材市場供需分析 :

[http://www.hbmsp.sipa.gov.tw:9090/itri/tw/images/NewsList1000913\\_04.htm](http://www.hbmsp.sipa.gov.tw:9090/itri/tw/images/NewsList1000913_04.htm)

資誠會計師事務所/PricewaterhouseCoopers (PwC) Taiwan (2012), 台灣醫療口業概況 : 市場挑戰與商機 :

[http://www.pwc.tw/zh\\_TW/tw/industries/publications/assets/healthcare-zh.pdf](http://www.pwc.tw/zh_TW/tw/industries/publications/assets/healthcare-zh.pdf)

劉慧俐(2007), 人口老化的趨勢與對策, 醫學社會學與社會工作學系

鄭力嘉 (1998), 影響網路使用者採行線上購物因素之研究, 國立屏東科技大學資訊管理碩士論文

*Creating an Audio-Tactile Braille Storybook for Visually Impaired Children: The  
Role of Audio Feedback in Inducing Pleasure*

Sara Partow

Islamic Azad University, Iran

0213

The Asian Conference on Psychology & the Behavioral Sciences 2013

Official Conference Proceedings 2013



iafor

iafor  
The International Academic Forum  
[www.iafor.org](http://www.iafor.org)

## Introduction

In the psychology of reading, choosing an appropriate and attractive book and engaging children with the book are two of the important issues in creating motivation and interest in a young reader. Given the choice, children choose story books with more illustrations (Edmunds and Bauserman 2006) and select books that are personally meaningful and interesting. There are some other ways to encourage children to read. In the past, teachers used methods and resources such as reading aloud and playing narrated audio recordings to motivate and teach reading skills. With the advances in educational technologies, computers, e-books (multi-media books) can have been more recently enlisted to stimulate the desire to read for pleasure (Strout 2010).

The research on traditional paper books can, with exceptions, be divided into two categories. The first category focuses on reading speed, getting information and reading comprehension. The second focuses on reading for fun and reading as a leisure activity. Research in this second category, includes preferring to read, motivation and enjoyment, but unfortunately when it comes to the electronic books most of the research has been done in the first category (Colombo and Landoni 2011, Moore 2009), and what has been emphasized is teaching reading skills to the children, rather than emotional aspects of an enjoyable reading (Skouge et al. 2007).

The e-book's interactivity gives feedback to the children. It engages them and encourages them to explore and to keep on reading. They change their attitude toward reading, increase their imagination and reading comprehension (De Jong and Bus 2003, Moody et al. 2010, Korat and Shamir 2010, Matthew 1996).

Multi-media books usually use visual features and visual feedback to engage their readers, when blind or visually impaired children only have their other senses to gather information (Crossan and Brewster 2008). This is unfortunate, because research shows that something like the engagement of multi-media books is just what blind and visually impaired children need to be able to read for pleasure. The research findings have two aspects.

Firstly, teachers of children with low vision report that, in general their students are poor readers. Research supports the observation that children with low vision do not read as well as sighted children of the same of age (Gadagbui and Ocloo 2008). Reading Braille takes longer than reading printed text. Print readers can read faster than a Braille reader (Fellenius 1999 and Eskenasi 2011). This slow progress is known to be demotivating (Sánchez and Galáz 2007), so it can be expected to hinder the exploration of Braille (Wright 2008), so the first learning of Braille needs to be a stimulating and an exciting experience (Hatlen and Spungin 2002).

Secondly, literature and reading story books for children with a disability are a kind of therapy; bibliotherapy, that can decrease the depression and negative emotions in these children (Myers 1998). For instance, trying to keep up with their peers without adequate support can cause visually impaired students to become clinically depressed (Freeman et al. 1989) and cause preschool children with visual impairment become segregated and socially isolated (Sacks and Gaylord 1989). So, there are additional benefits in reading books for blind children. Books can help them solve the problems that they encounter in their life. Books can assist them gain independence and to not feel sorrow for their disability (Pardeck 1993).

To provide blind children equal opportunities to enjoy reading with storybooks, the Braille publishers use tactile illustrations besides the Braille text of the books for

blind children. Like visual illustrations, tactile illustrations have been observed to add interest and meaning to story reading for blind children. Students with little previous interest in books, showed increased interest in reading tactile books. In addition, teachers report that some students use the book's tactile pictures to help them pretend read (Wright 2008).

However, a tactile illustration can never be as complete as a visual picture, as a blind child cannot see in perspective (Crossan and Brewster 2008). As it is two dimensional rendering of a three dimensional world, it is difficult for a blind child to comprehend, as spatial relationships are difficult to convey in a tactile illustration.

Psychophysical research indicated that congenitally blind people; people who lack any visual experience, have difficulty recognizing tactile pictures because of the haptic perception limitations and their lack of haptic experiences with tactile pictures (Heller et al. 1989, Lewis and Tolla 2003, Jeholet al. 2006, Pathak and Pring 1989, McCarthy 2005, McGee et al. 2001). However, experiments using haptic picture matching (to eliminate semantic memory) support the view that a good understanding of perception can be developed in the absence of visual experience (Heller et al. 2005). There is a body of research that supports the view that tactual picture perception is considerably more difficult than visual picture perception (Loomis and Klatzky 2007, Loomis et al. 1993). Research has concluded that tactile illustrations have always needed associated audio data; usually an explanation by a sighted person (Landua and Wells 2003, Walls and Brewster 2000). Braille explanations are of limited use because they considerably lengthen the book's Braille text, which tires children. In any case, some blind children (especially those who have developmental problems) show a lack of interest in haptic exploration of objects (Jan et al. 1983).

From the other side, multi-sensory research has indicated that we have separable spatial attention systems for touch and audition. There is some evidence that supports the hypothesis that the integration of information across different modalities facilitates perception (Hotting and Roder 2009, Lahav and Mioduser 2007, Jacko et al. 2003). For instance research shows that auditory cues automatically attract attention and that allocating attention to a sound facilitates visual processing as well (Hotting and Roder 2009).

Psychoanalytic study of children indicates that children tend to master their external world through activity. Blind babies attempt to produce sounds by performing a noisy activity and attempt to repeat the noises that they hear. Blind children show a high degree of sensitivity to noise and display an early development of skill in differentiating and imitating sounds. They can gain pleasure making and listening to the sounds (Sandler and Wills 1965). This is supported by controlled studies on sound and tactile picture perception that show, that in comparison with sighted people and in contrast their tactile picture perception, visually impaired subjects perform better in perceptual auditory tasks (Canadian National Institute for the Blind, 2012).

Work with visually impaired children with multiple disabilities, it was found that engaging auditory material prepares a child to search for and select from appropriate tactile targets (Goldware and Silver 1998). All this suggests that blind children's storybooks might be made more engaging if sounds and audio tracks were incorporated into them.

**Ideas, Design and Fabrication details:** In the idea stage I studied the Braille storybooks that had produced in Iran for Iranian blind children. In the school libraries there were no Braille story books with tactile illustrations for blind children. All the

books just had Braille text only and those with tactile illustrations, were picture books; story books with tactile illustration, without Braille text, for pre-school children.

To design, my Audio-Tactile Braille Storybook I considered, firstly the needs of visually impaired Iranian children and secondly, the desirable technical features of an Audio-Tactile Braille Storybook.

An Audio-Tactile Braille Storybook had to have a Braille story text because both Braille and story narrative play a very important roles in a visually impaired child's development, and it had to be suitable for the child's age as a beginner Braille reader in Iran. The story had to be related to Iranian culture and book had to use an accessible and low cost technology that was available in Iran.

The basic technical requirements of the Audio-Tactile Braille Storybook were firstly, that it had to be user friendly and affordable to the parents of visually impaired children. Secondly, it had to have a Braille text. Thirdly, it had to have a variety of sound effects or audio narrative buttons, and fourthly, it had to have a tactile illustration, with a single sound cue, on each page. I also particularly wanted the visually impaired children's parents to be able to add sounds and pages to the book, to create additional storybooks for their children.

My Audio-Tactile Braille Storybook consisted of hardware, software and book pages. The hardware had a PVC plastic frame. The enclosed panel consisted of two sections. The section on the left side, which was for placing the Braille text, was hard plastic and on the right side there was a touch panel, which was powered from the computer via a USB cable.

The software of the Audio-Tactile Braille Storybook was written with Delphi programming language with the use of Access Data Base. This software can be run on Windows XP or Windows 7 and it doesn't need installation. On selecting the title of the book, the main virtual window of the book appeared. This consisted of a blank page with ten buttons in a vertical column and a button for the single sound of the tactile picture on the page. It did not have any text or picture. It just had buttons that were connected to the sound files that had been saved on the hard disk of the computer. It also had buttons for going to the next or previous page. Figure 1 shows the touch screen display.

The book's pages were made of cardboard and had the Braille text glued on the left side and the tactile picture glued on the right side. Tactile plastic buttons with adhesive on the back side of them were stuck on the book's page in the margin between the Braille text and the tactile picture. Figure 2 shows an example of the page of the Audio-Tactile Braille Storybook.

The story I chose for my first Audio-Tactile Braille Storybook, was the story of, 'The Trundling Gourd'; 'kadooyeghelghelehzan'. This is an Iranian folk story. The version I used was a new Braille edition of thirteen paper pages. I chose suitable sound effects related to the story line on each page. As I added these to the software I stuck plastic buttons on the right side of the pages of the Braille text, in a vertical column coincident with the virtual buttons on the software window. I made the tactile pictures for the story with different textures. I used the special rules for making tactile pictures for blind children that comes from American Printing House for the Blind (American

Printing House for the Blind, 1997). Each page had a tactile picture and sounds, except page 7 of the book which did not have any sound buttons at all. It was silent. It had just Braille and a tactile picture. I planned this to see what the children's reactions and comments for this page would be after experiencing the previous pages with sounds.





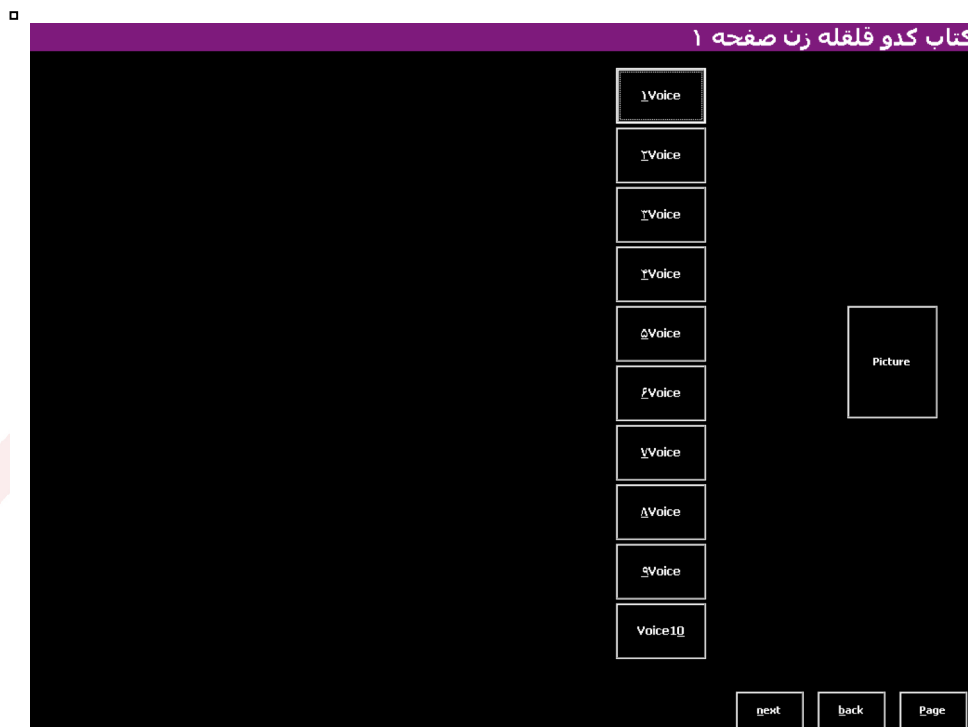

Figure 1 Audio-tactile touchscreen software display. The only the areas inside the button boxes are sensitive to touch. The numbered button boxes labeled Voice are linked to sound effects for the Braille text. The button box labeled Picture are linked to the sound effect for the picture, and the button boxes labeled 'next', 'back' and 'Page' effect navigation.

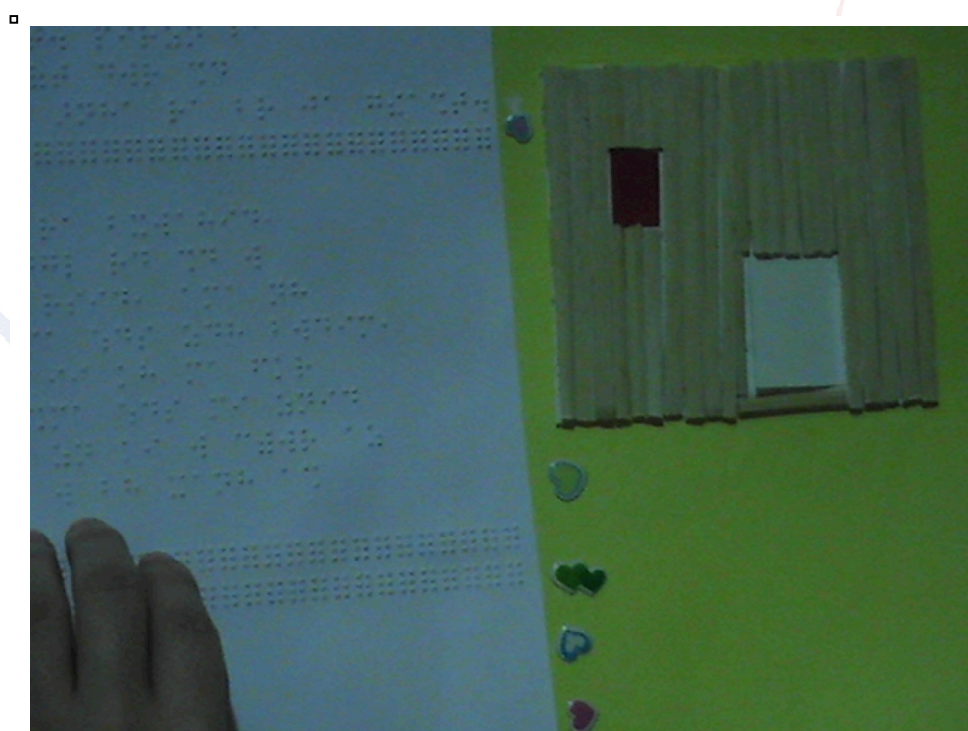

Figure 2 A page of the Audio-Tactile Braille Storybook. The Braille text is on the left-hand side. The tactile picture is on the right-hand side (the house with a door and a window). The sound buttons for the text are on the left-hand margin of the right-hand side.

### Research Method

A multiple case study research method was employed as an exploratory tool to evaluate the Audio-Tactile Braille Storybook from the point of view of four blind children. My research question was: What is the verbal or emotional reaction or feelings of the cases to the different features of the book being absent or present and why?

I used qualitative data that came out of the interviews and verbal reactions of four blind children during their interaction with the book and afterwards, in their home environment. I chose to conduct the interviews in their homes because children are more comfortable in their home. If children feel uncomfortable, they become silent and it may cause loss of data (Irwin and Johnson 2005). And because using a rating scale to measure children's enjoyment and feelings had not been recommended by previous researchers (Airey et al. 2002),

The questions were unstructured, exploratory and open-ended, based on research findings and literature, to involve children effectively in the design and evaluation process of the development of the Audio-Tactile Braille Storybook and to encourage them to share their real feelings and not just what they think is the correct answer, to please the interviewer (Hanna et al. 1997).

The data was gathered in one session (main session) for each case by going to the child's home for about two hours. All the main sessions were recorded with a handy camera. The sessions were in a friendly atmosphere, where child's mother was present. The main session was held after an introductory session with the child and the child's mother to make a friendly and warm relationship with children. They had no previous experience in reading Braille books with tactile pictures.

### Case reports (abridged interviews)

Table 1 gives the sex, age, degree of blindness and the current years of schooling of each case.

<b>Table 1 Cases</b>				
<b>Given name</b>	<b>Sex</b>	<b>Age</b>	<b>Degree of blindness</b>	<b>School</b>
<b>Case 1</b>	female	7	blind, no sight	1 <sup>st</sup> year
<b>Case 2</b>	male	9	blind, no sight	3 <sup>rd</sup> year
<b>Case 3</b>	male	8	partially sighted, read Braille only	2 <sup>nd</sup> year
<b>Case 4</b>	male	8	partially sighted, read Braille only	2 <sup>nd</sup> year

### **Case 1:**

She touched one of the tactile picture that was made of a piece of velvet and said, "How soft it is. I love it, I want to eat it and I want to eat it". She pushed the tactile picture and heard a wolf sound. She said, "What is this?" I told her it was wolf. She touched it and again said, "It is very soft, I like it." She touched the tactile picture of a house that was made of scrubby paper and said, "Oh! How rough it is, I do not like it" Before exploring tactile pictures she preferred to hear its sound. She pressed the picture of a cloud that was made of a piece of padding. She said, "It is a cloud" and became happy at this exploration. She pressed the picture three times and listened to the thundering and raining sound. She was opening and closing the door of the houses and also the windows. She said, "I am opening the door. I am closing the door. I am opening the window. I am closing it."

She pressed one of the buttons and said, "I love it". It was the sound of a baby crying. She pressed that button four times and listened and laughed. "I love this baby, Cute! Cute!" She played the sound of baby crying and car and rain and dog and bathing more than three times each and enjoyed them. She heard these once and said nothing. She pressed the sound buttons on a page that had a tactile picture of a house. The sounds on that page were dialogs between the old woman and her daughter and also the sounds of purring and a cricket and a door opening, and then she said, "Where is the doorbell sound? I wish it had a door bell." She played the sound of the lion for many times and imitated that sound. She was laughing and she said, "This lion is powerful. I wish this lion would eat the old woman." When she reached to the page 7 (that had no sound buttons and just had brailled text and a tactile picture) she said, "This page doesn't have sound? Why? Can you put sounds on it now? I wish it had sounds. I want it. After she read page 10, her mother said that: "She, your friend Leila has come here. She shouted "Hey Leila! I will come soon". Then she said, "How many pages left? I want to listen to all sounds and then I will go". She said that she just want to press the buttons and heard sounds. She didn't want to touch other tactile pictures and read the Braille text. She said I love the book with sounds and tactile pictures.

I said, "I want to remove sounds or tactile

### **Case 2:**

He started from the first page and listened to the sounds one by one. He was interested in talking about the sounds. When he listened to the bathing sound, he said, "This shower does not work well." When he heard the rooster sound he said, "This rooster is sick". When he heard the sheep sounds, he said, "These sheep are unsettled".

He listened to the rest of sounds up to page 4. He then continued reading. He didn't care about the tactile pictures. When I remind him that there are tactile pictures in each page, he touched it quickly and pressed its sound and then said, "Okay I want to go to the next page. Let's see what the sounds are". He read the text and listened to the sound buttons of the pages up to page 6 but he didn't touch any of the tactile pictures of the first six pages. Only when I remind him that there is a tactile picture in each page, he touched it very quickly. In page 7, he was exploring the page. After a few second he shouted: "It doesn't have buttons" And when I said, "This page doesn't have sound". He said, "I am tired. That's enough for today". When I said, "Just this page doesn't have sound." He said. "No, I am tired"

### **Case 3:**

He started reading the Audio-Tactile Braille Storybook. After he finished the first page He said, "It is very interesting. Can I read this book again? I want to read it again tomorrow." He kept reading until the end.

He was touching the pictures first and then he was bending his head and using his

remaining sight. He preferred to touch pictures after reading each page and listening to the sounds of the pictures. He didn't talk while exploring the pictures and hearing their sounds. He sometimes forgot to touch some pictures.

When he reached to page 7, which did not have sound buttons, he said, "Oh it doesn't have sound button? I don't like this page". He didn't miss pressing a button on any page. He sometimes pressing some buttons and he would say something. He pressed the buttons of the kiss sound three times and said, "She kisses three times". Another time he laughed and said, "These birds are like my grandmother's birds." He asked: "What is this?" When he heard the sounds of frog, he said, "Aha! This is frog. I had heard this in my grandmother's house." After finishing each page he said, "It is very interesting. It is a very good book. I love the sounds."

#### **Case 4:**

He started reading book. He said, "What an interesting book. I had not seen something like this before. I like it. It is the best. It is my best book. Can I have it?" He preferred to touch the tactile pictures before a reading each page. He would touch the pictures first and then he would bend his head and using his remaining sight. He was asking himself, "What is this?" before he pressed the picture he would like to make a guess. "It is a dog", he said. He kept on this game until the last page of the book. He read the book up to end. He enjoyed touching pictures and making a guess. Then he pressed them and answered his question. For each picture he was asking, "It is very interesting. How did you make this picture? What is its material? It should be cloth. Oh! This one is hair. These are buttons of your previous clothes? This house has made of wood? Do you have a garden in your house? Did you make it from your trees?" He loved the telephone pictures and the car picture. He pressed each of them more than fifteen times. He pressed the telephone and said, "This telephone is cute!" And he said, "This car is very cute. Its wheels are very cute! Its sound is very cute!" During reading of the page about the telephone and the car he pressed the telephone or car picture after reading a line and when it was playing he kept reading. When he reached to page 7, which did not have sound buttons, he said, "Where are the sound buttons? It's a pity. Make sound for this one too" He said, "Can I read this book again? When will you bring it for me? I want to read it again. It is very, very interesting."

## Results

Table 2 summarizes some main results of the interviews; the cases' reactions to the tactile pictures, the sounds they particularly responded to and persistence with reading of the Braille text.

<b>Given name</b>	<b>Pictures</b>	<b>Sounds</b>	<b>Reading</b>
<b>Case 1</b>	Soft, tough. She liked both texture and sound	baby, cloud, lion (no doorbell)	She kept reading until the end.
<b>Case 2</b>	He didn't touch all the tactile pictures. He was only interested in the pictures' sounds.	bathing, rooster, sheep "This rooster is sick".	He kept reading although he was tired, but only read the first 6 pages.
<b>Case 3</b>	He touched pictures after reading and listening to their sounds. He didn't talk. He forgot to touch some pictures.	kiss, birds, frogs. "I have heard this in my grandmother's house."	He kept reading until the end. He did not miss a single sound button.
<b>Case 4</b>	He enjoyed touching pictures and making a guess at what they were.	car, telephone "Its wheels are very cute!"	He kept reading until the end.

Table 3 summarizes the responses to the option of having either the tactile pictures or the sound effects removed from the Audio-Tactile Braille Storybook.

<b>Case</b>	<b>Page 7 reaction</b>	<b>Sounds or tactile picture</b>
<b>Case 1</b>	"This page doesn't have sound? Why?", "I wish it had sounds."	"I want both.", DECISION: "I will not like this book if you remove the sounds."
<b>Case 2</b>	"This page doesn't have sound", "I am tired. That's enough for today".	DECISION: "I want sound buttons. They are very interesting."
<b>Case 3</b>	"Oh it doesn't have sound button? I don't like this page".	"Keep both!", DECISION: "Sounds." "Pictures are hard to recognize."
<b>Case 4</b>	"Where are the sound buttons? It's a pity."	"I want both.", DECISION: "Sounds. They are amusing".

## Discussion and Conclusion



The children in this study had severe visually impairments that vary in their degree and it is known that differences between the degrees of blindness can impact on the results (Loomis et al. 1991). Otherwise, what we understand to be true of children in general, is applicable to these children. So, what we draw from these four interviews will be impacted upon by the age, the verbalization capability and their personality traits, such as extroversion or introversion of each child. For example, research shows that the extroversion of children may affect whether they talk about their thoughts more than introverted children (Donker and Markopoulos 2002), and other research indicates that, when reading for pleasure, there are significant differences between the reading habits of boys and girls. Girls read more for pleasure and they enjoy reading as a leisure activity more than boys (Clark and Rumbold 2006).

In general the verbal emotional reaction of all four cases was negative to page number 7. This page was the only page of the book that had no sounds. It just had a tactile picture. In all cases the children's reaction to this page supports the view that the sounds play an important role in the book. All the cases were in agreement that tactile pictures could be removed from the book and all of them were insistent on keeping the sounds in the book. They did not want the sounds omitted. Given the choice of omitting the sounds or the tactile pictures, their choice was to omit the tactile pictures. Also all the cases showed less attention to the shape of the tactile pictures. Most of the attention was to the texture and material. Case 1: "How soft it is" or Case 4: "It should be cloth, it is wood" and cases 2 and 3 did not give any verbal emotional reaction to the tactile pictures, in contrast to their reactions when listening to sounds. In some cases they forgot to touch some of the pictures.

However, there are some differences in the quality of these results that can be inferred to be due to the differences between these four individuals. Case 3, in explaining his preference for the sounds rather than tactile pictures, he says that tactile pictures are hard to perceive and they need more attention. In that case the subject was partially sighted and he had an overview of each tactile picture and he could distinguish some high contrast colours and shapes. Cases 1 and 2 said that they like the sounds more than tactile pictures. Case 4 said that sounds were more amusing than the tactile pictures. Case 1 did not want to read the book at first but she was attracted to the book after hearing the sound. When her friends came, she took into consideration two exciting alternatives and she had to choose which was more pleasurable for her - reading the Audio-Tactile Braille Storybook or playing with her friend. She decided that she wanted to listen to the rest of the sounds of the book before she went to play with her friend. Case 2 kept reading although he said he was tired and he stopped reading when he reached to page 7 which didn't have sounds. He also missed exploring some tactile pictures. When he was reminded of this he scanned them quickly and said: "Let's see what the sounds are." He did not miss even one sound button. Case 3 preferred the sounds because he stated that tactile perception is hard for him because he had to pay more attention to perceive them. While case 4 was very excited about the tactile pictures and made many comments on them and had some



verbal reactions on them, he stated that the sounds were more amusing. This is also true of case 1. Although she liked some of tactile pictures and she gave some verbal positive reaction, such as "How soft it is. I want to eat it", she stated that the sounds were better than tactile pictures. Notably, Cases 1, 3 and 4 wanted to keep both the sounds and the pictures.

The cases differed in their degree of blindness. Cases 3 and 4, who could both see large objects and high contrasting colours, tended to use their remaining sight after touching tactile pictures by bending their heads. Case 4 tended to make a guess on seeing pictures that had high contrast in their colours. For example he said: "This house is black", although it was blue.

In summary observations attributed to the similarities of the individuals were as follow:

1. Exploration of the tactile pictures was confined to exploring the texture of the materials.
2. All gave negative response to silent page 7.
3. All ultimately chose to keep the sounds but not the pictures.
4. In all cases, the sounds stimulated the children's curiosity and interest more than the tactile pictures did.

Observations attributed to the individual differences between the cases are as follows.

1. Case 2 was induced to continue reading by the pleasure of the sounds.
2. Case 3 found sounds more pleasurable than perceiving tactile pictures.
3. Case 4 and Case 1 enjoyed the texture of the pictures but the sounds were more important than texture in inducing pleasure.
4. Case 3 and Case 4 needed to use their remaining sight to assist in their perception of the pictures.

### **Conclusion**

My overall conclusion is that although both sounds and tactile pictures were two important features that induce pleasure in some cases, sounds, in comparison to tactile pictures, were found to be significantly more effective in inducing pleasure in the blind or partially sighted children who were the cases of this study.

### **Further research suggestions:**

1. This preliminary study could be extended by interviewing other blind children and developing other Audio-Tactile Braille Storybooks.
2. This research can be done with other research methods and analysed quantitatively to test the validity of the conclusions of this study.

## Limitations

This research had some limitations as follow:

1. The sample size was small and cannot be representative of the entire community of Iranian blind children; four interviews from one source cannot be generalized to all blind or VI children.
2. The low level of ability of cases to recognize and portray their feelings towards their reading of the Audio-Tactile Braille Storybook due to their age and their disability.
3. The Audio-Tactile Braille Storybook that I designed and fabricated was not a fully interactive e-book. It was a makeshift prototype. Only the audio feedback (the sound buttons) were under the control of the users.

NB The tactile feedback of the Braille text and tactile illustrations was deliberately chosen to be static, because I wanted to use the low cost and accessible technology that existed in Iran.

## Acknowledgement

I am grateful to the four VI children, their parents and their teachers for their cooperation and participation in this research.

## References

- American Printing House for the Blind 1997, Retrieved from American Printing House for the Blind: [www.apf.org](http://www.apf.org).
- Airey, S, Plowman, L, Connolly, D and Luckin, R 2002, "children's enjoyment of toys, games and media", *Presented at 3rd World Congress of the International Toy Research Association on Toys, Games and Media. London.*
- Canadian National Institute for the Blind 2012, Retrieved from CNIB: [www.cnib.ca](http://www.cnib.ca)
- Clark, C and Rumbold, K, 2006, "Reading for pleasure: A research overview", London: National Literacy Trust.
- Colombo, L and Landoni, M 2011, "Towards an engaging e-reading experience", *Proceeding BooksOnline*,
- Crossan, A and Brewster, S 2008, "Information and Trajectories to VI Computer Users", *ACM Transactions on Accessible Computing*, vol. 1, no. 2.
- De Jong, M T and Bus, A G 2011, "How Well Suited are Electronic Books to Supporting Literacy?" *Early Childhood Literacy*, vol. 11, no. 1, pp. 73-94.
- Donke, A and Markopoulos, A 2002, "A Comparison of Think-aloud, Questionnaires and Interviews for Testing Usability with Children", *Computers XVI – Memorable yet invisible* pp. 305-316. *Proceedings of HCI*.
- Edmunds, K L and Bauserman, K L 2006, "What Teachers Can Learn About Reading Motivation Through Conversations With Children", *The Reading Teacher*, vol. 59, no. 5, pp. 414-454.
- Eskenazi, M 2011, "Captioned Braille Radio", Towson University & NPR Labs International Center for Accessible Radio Technology.
- Fellenius, K 1999, "Computer-based instruction for young braille readers in

- mainstream education – an evaluation study", *Visual Impairment Research*, vol. 1, no. 3, pp. 147-164.
- Freeman, R D, Goetz, E, Richards, D P, Groenvelde, M, Blockberger, S, Jan, J E and Sykanda, M, 1989, "Blind children's early emotional development: do we know enough to help?", *Child: Care, Health and Development*, vol. 15, no. 1, pp. 3–28.
- Gadagbui, G Y and Ocloo, M A 2006, "The attitude of children with low vision towards Braille as a system of written communication in schools for the blind in Ghana", Kuala Lumpur: *Proceedings of the 12th world conference*, PUTRA World Trade Centre.
- Goldware, M, Silver, M 1998, "AAC strategies for young children with vision impairment and multiple disabilities", California School for the Blind.
- Hanna, L, Ridsden, K and Alexander, K 1997, "Guidelines for usability testing with children", *interactions*, vol. 4, no. 5, pp. 9 - 14.
- Hatlen, P and Spungin, S J 2008, "The Nature and Future of Literacy: Point and Counterpoint", *Visual Impairment & Blindness*, pp. 387-396.
- Heller, M A, McCarthy, M and Clark, A 2005, "Pattern Perception and Pictures for the Blind", *Psicológica*, vol. 26, pp. 161-171.
- Heller, M A., McCarthy, M, Schultz, J, Greene, J, Shanley, M, Clarck, A, Skoczylas, S and Prociuk, J 2005, "The influence of exploration mode, orientation, and configuration on the haptic Müller-Lyer illusion", *NCBI*.
- Hötting, K and Röder, B 2009 "Auditory and auditory-tactile processing in congenitally blind humans", *Hearing Research*, vol. 258, no. 1-2, pp. 165–174.
- Irwin, L G and Johnson, J 2005, "Interviewing Young Children: Explicating Our Practices and Dilemmas", *Qual Health Res*, vol. 15, no. 6, pp. 821-831.
- Jacko, J A, Ingrid, U, Scott, I U, Sainfort, F, Barnard, L, Edwards, P J, Emery, V K, Kongnakorn, T, Moloney, K P and Zorich, B S 2003, "Older Adults and Visual Impairment: What Do Exposure Times and Accuracy Tell Us About Performance Gains Associated with Multimodal Feedback?", *Computer Human Interaction*, vol. 5, no. 1, pp. 33-40.
- Jan, J E, Groenvelde, M and Sykanda, A M 1983, "Behavioural Characteristics Of Children With Permanent Cortical Visual Impairment", *Developmental Medicine & Child Neurology*, vol. 29, no. 5, pp. 571–576.
- Jehoel, S, McCallum, D, Rowell, J and Ungar, S 2006, "An empirical approach on the design of tactile maps and diagrams: The cognitive tactualization approach", *British Journal of Visual Impairment*, vol. 24, no. 2, pp. 67-75.
- Korat, O and Shamir, A 2007, "Electronic books versus adult readers: effects on children's emergent literacy as a function of social class", *Computer Assisted Learning*, vol. 23, no. 3.
- Lahav, O and Mioduser, D 2008, "Haptic-feedback support for cognitive mapping of unknown spaces by people who are Blind", *International Journal of Human-Computer Studies*, vol. 66, no. 1, pp. 23-35.
- Landua, S and Wells, L 2003, "Merging tactile sensory input and audio data by means of the talking tactile tablet", *EuroHaptics '03, IEEE Computer Society*, pp. 414-418.
- Lewis, S and Tolla, J 2003 "Creating and Using Tactile Experience Books for Young Children With Visual Impairments", *TEACHING Exceptional Children*, vol. 35, no. 3, pp. 22-28.
- Loomis, J M, Klatzky, R L, Golledge, R G, Cicinelli, J G, Pellegrino, J W, Fry, P A 1993, "Nonvisual Navigation by Blind and Sighted: Assessment of Path Integration Ability", *Experimental Psychology General*, vol. 122, no. 1, pp. 73-91.
- Loomis, J M, Klatzky, R L and Lederman, S J 1991, "Similarity of tactual and visual

- picture recognition with limited field of view", *Perception*, vol. 20, pp. 167- 177.
- Loomis, J M and Klatzky, R L 2007, "Functional equivalence of spatial representations from vision, touch, and hearing: relevance for sensory substitution", *In A. D. Rieser J. J., Blindness and brain plasticity in navigation and object perception*, pp. 155-184. New York: : Lawrence Erlbaum Associates
- Matthew, K I 1996, "The Impact of CD-ROM Storybooks on Children's Reading Comprehension and Reading Attitude", *Educational Multimedia and Hypermedia*, vol. 5, no. 3, pp. 379-394.
- McCarthy, C 2005, "Toward a Definition of Interiority", *Space and Culture*, vol. 8, no. 2, pp. 112-125.
- McGee, M A, Gray, Pand Brewster, S 2001, "The Effective Combination of Haptic and Auditory Textural Information", *Lecture Notes in Computer Science*, 2058, pp. 118-126.
- Moody, A K, Justice, L M and Cabell, S Q 2010, "Electronic versus traditional storybooks: Relative influence on preschool children's engagement and communication", *Early Childhood Literacy*, vol. 10, no. 3, pp. 294-313.
- Moore, L M 2009, "At your leisure: Assessing ebook reader functionality and interactivity", *Faculty of Life Sciences, University College*.
- Myers, J 1998, "Bibliotherapy and DCT: Co-Constructing the Therapeutic Metaphor", *Counseling & Development*, vol. 76, no. 3, pp. 243-250.
- Pardeck, T J 1993, "Literature and adoptive children with disabilities", *Early Child Development and Care*, vol. 91, no. 1, pp. 33-39.
- Pathak, K and Pring, L 1989, "Tactual picture recognition in congenitally blind and sighted children", *Applied Cognitive Psychology*, vol. 3, no. 4, pp. 337-350.
- Sacks, S and Gaylord-Ross, R 1989, "Peer-Mediated and teacher-directed social skills training for VI students", *Behavior Therapy*, vol. 20, no. 4, pp. 619-640.
- Sánchez, J and Galáz, I 2007, "AudioStoryTeller: Enforcing Blind Children Reading Skills", *Human Computer Interaction*, vol. 7, pp. 786-795.
- Sandler, A M and Wills, D M 1965, "Preliminary notes on play and mastery in the blind child", *Child Psychotherapy*, vol. 1, no. 3.
- Sheppard, L and Aldrich, F K 2001, "Tactile graphics in school education: perspectives from teachers", *British Journal of Visual Impairment*, vol. 19, no. 3, pp. 93-97.
- Skouge, J R, Rao, k and Boisvert, P C 2007, "Promoting Early Literacy for Diverse Learners Using Audio and Video Technology", *Childhood Education*, vol. 35, no. 1, pp. 5-11.
- Strout, K A 2010, "Average, Below Average, And Above Average First Grade Students' Beliefs about Using E-Books to Activate Interest and Motivation in Reading", *Bowling Green State University*.
- Wall, S, Brewster, S 2000, "Feeling what you hear: tactile feedback for navigation of audio graphs", *SIGCHI Conference on Human Factors in Computing Systems*, pp. 1123-1132, New York.
- Wright, S 2008, "Guide to Designing Tactile Illustrations for Children's Books", *American Printing House for the Blind*.

*Risk Assessment Tool for Adverse Outcomes of Occupational Stress: Development  
and Investigation of its Psychometric Properties*

Nataša Sedlar\*<sup>1</sup>, Tatjana Novak\*<sup>1</sup>, Lilijana Šprah\*<sup>1</sup>, Gregor Sočan\*<sup>2</sup>

\*<sup>1</sup>Sociomedical Institute at Scientific Research Centre of the Slovenian Academy of  
Sciences and Arts, Slovenia, \*<sup>2</sup>University of Ljubljana, Slovenia

0220

The Asian Conference on Psychology & the Behavioral Sciences 2013

Official Conference Proceedings 2013

Abstract

**Introduction** While psychosocial factors at work have been widely mentioned as important contributors to occupational stress, only recent research suggests that some non-work factors (e.g. some socioeconomic, personality and health risks) could also contribute to the adverse outcomes of work-related stress. **Objective** The aim of our study was to develop a comprehensive instrument that would include a broad spectrum of work and non-work risks related to adverse negative outcomes of occupational stress. **Methods** A preliminary version of the instrument was obtained through three consecutive rounds of a Delphi study. Seven qualified experts in the workplace stress field, who participated in the first round, proposed and evaluated risk factors for adverse outcomes of occupational stress. The proposed most prominent risk factors were later reassessed in two online surveys by an expanded group of 20 experts. The final version of the instrument consisted of 130 risk factors, which were classified into 17 categories based on substantive considerations. **Results** After the questionnaire had been completed by 349 Slovenian employees in different occupations a principal component analysis (PCA) was conducted. A four component solution (Direct Oblimin rotation, 68% explained variance) showed minimal cross-loading and reduced the used variables into the following components, i.e. (i) organizational context, (ii) socio-economic characteristics of the employee, (iii) job characteristics and (iv) individual characteristics of the employee. **Conclusion** The study represents an important step toward the development of a comprehensive instrument for identifying potential risk factors associated with harmful work-related outcomes. Further validation of the tool in different work settings and samples is needed.

**Keywords:** occupational stress, assessment tool, risk factors, principal component analysis



## Introduction

Over the last decades work-related stress gained an increased attention among professionals and researchers (e.g. recently published European researches: Esener (EU-OSHA, 2010), European Working Conditions survey (EUROFOND, 2010)) due to its negative impact on employees, organizations and national economies.

The most commonly-used definition of work-related stress implies that high levels of stress at work are experienced when the demands of the work environment exceed the employees' ability to cope with (or control) them (Milczarek, Schneider & Rial Gonzalez 2009). A growing body of evidence suggests that one of the most undesirable consequences of work-related stress is impaired employees physical and psychological health. (EUROFOND 2007; WHO 2005). Moreover, there are several studies indicating the negative impact of long-term experience of work-related stress on organizational outcomes, such as increased sick leave (absenteeism; Johns 2003), turnover (Bergerman, Corabian & Harstall 2009) and burnout (Maslach, Schaufeli & Leiter 2001), reduced workplace productivity (presenteeism; Johns 2010) and negative consequences associated with work-to-family conflict of employees (Amstad, Meier, Fasel, Elfering & Semmer 2011).

A number of factors can contribute to the experience of work-related stress if not managed properly (e.g. Kopp, Stauder, Purebl, Janszky & Skrabski 2007; Leka, Griffiths & Cox 2003) Besides widely recognized psychosocial risk factors at work arising from job characteristics (e.g. work content, work pace, overload, work schedule, control over work, employee's qualification, participation in decision making, salary), work environments or work organisation (possibilities for career development opportunities, role of an employee in the organisation, interpersonal relations, organisational climate), some non-work factors, such as socio-demographic characteristics of an employee, economic circumstances, family relations, health status, lifestyle, quality of life, technological development, market changes (Pološki Vokić & Bogdanić 2007) could also contribute to the increased experience of work-related stress.

Moreover, different social and economic circumstances may affect subjective experience of work-related stress indirectly through working conditions. For instance, Stauder, Konkoly, Kovács, Balog, Williams and Williams (2010) suggested that the transition from socialism to capitalism results in higher stress because of increased workplace competition and job demands and decreased job security and wages in many sectors. Workplace stress has been also shown to have different effects on the health of employees in different countries (Salavecz et al. 2010).

Slovenian employees may even be more prone to experience workplace stress due to some unique economic, and health characteristics related to low flexibility of the Slovenian labour market (Eurostat 2011a, 2011b), higher levels of absenteeism (Parent-Thirion, Fernández Macías, Hurley & Vermeulen 2005) and lower job satisfaction (Parent-Thirion, Vermeulen, van Houten, Lyly-Yrjänäinen, Biletta & Cabrita 2010) compared to the EU average. Additionally, research also indicates more physical complaints such as back pain, muscle pain, headache (Parent-Thirion et al. 2005), higher prevalence of unhealthy lifestyle, such as unhealthy diet, insufficient physical activity and smoking (Hlastan-Ribič, Djomba, Zalatel-Kragelj, Maučec-



Zakotnik & Fras 2010), one of the highest suicide rates (Parent-Thirion et al. 2005) and alcohol-related morbidity and mortality rates (WHO 2011) in Europe.

In the light of these distinct labour and health characteristics pertaining to Slovenia, we claim that currently available questionnaires for workplace stress assessment (Tabanelli, Depolo, Cooke, Sarchielli, Bonfiglioli, Mattioli & Violante 2008) insufficiently capture broader relevant socio-demographic and labour market peculiarities in different EU countries. Therefore, the aim of the presented study was to develop a comprehensive instrument that would include a broader set of work-related and non-work-related risk factors associated with job stress and its adverse negative outcomes, such as absenteeism, presenteeism, turnover, burnout and work-family conflict and to analyze its psychometric properties.

## **Method**

### **Instruments**

**Development of the risk assessment tool** (Sedlar, Novak & Šprah 2012a) underwent three main phases.

First of all, a preliminary list of risks, related to absenteeism, presenteeism, turnover, burnout and work-family conflict has been established. This phase included a) a review of relevant international research literature on workplace stress, b) a review of Slovenian publications addressing workplace stress, identified via a Co-operative Online Bibliographic System search (from January 2004 through December 2010), using the keywords: burnout, stress management, stress risk factors, job satisfaction, mobbing, staff turnover, absenteeism, presenteeism (Sedlar, Novak & Šprah 2012b), c) an analysis of socio-demographic, health, economical statistical indicators by Slovenian statistical regions from 2004 to 2010 (Novak, Šprah & Fridl, 2012), d) the focus group, where a group of 7 qualified experts in the workplace stress and stress-related fields proposed risks which in their opinion were related to workplace stress. In addition, they were asked to rate on a five-point Likert scale (1 = very unimportant to 5 = very important) the influence that each of the 186 risk factors obtained in previous phases had on absenteeism, presenteeism, turnover, burnout and work-family conflict. The second questionnaire was designed on the basis of the assigned importance to each risk factor (mean values,  $M > 2$ ) and the degree of consensus amongst experts (lower standard deviations, SD).

In the second phase an expanded group of 23 experts and researchers in the workplace stress and stress-related fields reassessed the most prominent risks from the first round on a five-point Likert scale (1 = very unimportant to 5 = very important). Based on high  $M$ , low  $SD$  and high discriminability of the risks obtained in the two consecutive rounds of an online survey a prioritised list of risks related to absenteeism, presenteeism, turnover, burnout and work-family conflict was established.

In the third phase a pilot version of the risk assessment tool was developed and validated in the pilot sample. 130 risk factors obtained in previous phases were transformed into self-rating items, asking respondents to evaluate how much they agree with each of the statement on a five-point Likert scale (1 = strongly disagree/very unlikely for me to 5 = strongly agree/very likely for me) in the last year. Example items are: 'I get little support from my organisation for dealing with difficult

situations.’ ‘There is a lot of competition among co-workers in my work organisation.’ ‘My work is very demanding.’ ‘I have difficulties with effective time management.’ In qualitative content analysis of the risks 17 categories of risk factors were created, 10 categories cover work-related risks (work context and work content) and 6 categories contain risks assessing broader psychosocial context (Table 1). Adequate face validity of the final 130-item version of the risk assessment tool was proven in a pilot sample of 60 Slovenian hospital employees (Sedlar, Novak & Šprah 2012c).

## Procedure

**Data collection.** 141 of participants were employees in four different work organizations from different economic sectors (health, construction, industrial work) that took part in the project »The Support Programme for Employers and Employees for Reducing Work-related Stress and Its Adverse Effects«. The rest of the data were collected from the employees of the Slovenian Association of Free Trade Unions (N=33), employees of various police directorates across Slovenia (N=83), and a convenience sample of Slovenian employees in different occupations (N=92). The approval of the local psychological ethics committee had been obtained prior to the study.

**Analyses.** Missing data were imputed using the EM algorithm, which has been demonstrated to be an effective method of dealing with missing data (Graham, 2009), and all analyses were conducted using a total of 349 participants.

SPSS Statistics 21.0 (SPSS Inc., Chicago, IL, USA) was used to perform all the statistical analyses. A principal component analysis (PCA) was performed to analyse the underlying structure of the risk assessment tool. A Direct oblimin rotation with Kaiser normalization, that allows the factors to be intercorrelated was used to ease interpretation of the results. The criterion used to select the number of factors was an eigenvalue greater than 1. The component score coefficient matrix and component correlations were reported. Internal reliability coefficient (Cronbach's alpha) was determined for each of the scales implied by the qualitative content analysis to evaluate the obtained component structure.

## Participants

The sample consisted of 349 Slovenian employees of various occupations, 170 (49%) of which were male and 179 (52%) female. 26.4% of the participants were from 41 to 50 years old, 35.1% from 31 to 40 years old, 22.6% from 20 to 30 years old, 15.9% more than 50 years old and 8.1% less than 20 years old. Most of the participants completed either high school (35.5%), university (28.5%), vocational (7.6%) or higher vocational school (11.8%). The majority of participants worked primarily with people (39.7%), 36.6% worked primarily with things and 20.8 % worked primarily with information according to Things-Data-People taxonomy (Fine and Cronshaw, 1999). They were employed in a wide variety of sectors: industry or manufacturing (18.3%), health care and social work (20.8%), education (5.1%), construction (8.7%), government, public administration and defence (34.6%), trade (0.6%), banking, financial services and insurance (1.1%), communication (4%), accommodation and food service (3%), arts, entertainment and recreation (0.6%), professional, scientific and technical activities (2.0%), transportation (0.8%) other or not defined (7.3%). The

mean working experience was 14.7 years (SD = 12.2), the mean organizational tenure was 9.6 years (SD = 8.9). 90.2 percent of the sample worked under long-term and 9.8 percent under short-term contract.

## Results

This section consists of three parts. We begin with the presentation of categories of a pilot version of the risk assessment tool, followed by the results of the Principal Components analysis with Direct oblimin rotation. Finally, we present the results of the reliability analysis for variant scales.

### Descriptive statistics

Categories of stress related hazards with corresponding risk factors are displayed in the Table 1.

Table 1. Categories of a pilot version of the risk assessment tool.

Category	Description
ORGANISATIONAL CULTURE AND FUNCTION	Poor communication, low levels of support for problem-solving and personal development, lack of definition of organisational objectives, lack of health and safety practices of employer, discriminating practices of employer, violations of the law by employer.
ORGANISATIONAL STRUCTURE	Changes in the work organisation (restructuring, laying off employees,..), understaffed work organization, indebted work organization, complex hierarchical structure of work organization, unqualified managers.
ROLE AND RESPONSIBILITY IN THE ORGANISATION	Role ambiguity and role conflict, responsibility for people, continuously working with other people, emotionally demanding work, wrong decisions can have serious consequences.
CAREER DEVELOPMENT	Career stagnation and uncertainty, under or over promotion, poor pay, job insecurity, job uncertainty, low social value to work, precarious work.
PARTICIPATION	Low participation in decision making, lack of control over workload, work pace, working hours, excessive control over the employees by the managers.
INTERPERSONAL RELATIONSHIP AT WORK	Social or physical isolation, poor relationships with superiors, interpersonal conflict, lack of social support, competition among co-workers, bullying/harassment.
HOME-WORK INTERFACE	Conflicting demands of work and home, low support at home, work-life balance practices offered by employer, dual career problems, being engaged in other works or additional education/training besides job.

TASK DESIGN	Monotonous work, short work cycles, fragmented or meaningless work, underuse of skills, high uncertainty, changes of work procedures, task-switching.
WORKLOAD/WORK PACE	Work overload or underload, lack of control over pacing, demanding work, more than one tasks at a time, high levels of time pressure, constant deadlines, unrealistic job expectations from an employer.
WORK SCHEDULE	Shift working, rigid work schedules, unpredictable hours, long or unsocial hours, lack of breaks.
WORK ENVIRONMENT/ EQUIPMENT AND PHYSICAL STRAIN	Problems regarding reliability, availability, suitability and maintenance or repair of both equipment and facilities; inadequate working conditions due to lack of proper working space, poor lighting, and noise.
FAMILY CIRCUMSTANCES	Single parent family, caring for family member with a long term illness, relationship problems with spouse and children, changes in family.
PSYCHO-PHYSICAL HEALTH STATUS	Physical or psychological illness or proneness to illness.
PERSONALITY TRAITS	Perfectionism, fear of making mistakes, disorganisation, overestimating one's abilities, indulgence, bad working habits, poor flexibility.
ATTITUDES TOWARDS WORK	Work is important value, conflict between work and personal values, the need to prove oneself at work, the need for self-affirmation, pessimism regarding work, feeling fed up with work, lack of career goals.
SELF- CARE	Unhealthy life style, unused vacation or sick leave, lack of time for oneself, friends, leisure activities, unhealthy strategies for coping with work stress.
SOCIO-DEMOGRAPHIC BACKGROUND	Inadequate living conditions, very low income, debt, few traffic connections between work and home, difficult access to kindergartens and health institutions, increased feelings of insecurity in the society.

First seven categories (organizational culture and function, organizational structure, role and responsibility in organization, career development, participation, interpersonal relationship at work, home-work interface) refer to work-context, next four (task design, workload/work pace, work schedule, work environment/equipment and physical strain) to content of the work, while the last six categories (family circumstances, psycho-physical health status, personality traits, attitudes towards work, self-care, socio-demographic background) refer to socio-demographic factors.

The responses on all items ranged between 1 and 5. Table 2 presents the descriptive statistics for all categories of the risk assessment tool.

Table 2. Descriptive statistics for a pilot version of the risk assessment tool.

Category	Number of items	M	SD	Alpha
Organizational culture and function	10	2.77	0.86	.86
Organizational structure	7	2.35	0.68	.52
Role and responsibility in organization	8	3.19	0.77	.63
Career development	10	2.67	0.70	.72
Participation	4	2.66	0.83	.60
Interpersonal relationship at work	7	2.33	0.68	.71
Home-work interface	8	2.47	0.73	.58
Task design	6	2.57	0.67	.47
Workload/work pace	9	3.12	0.63	.69
Work schedule	6	2.26	1.04	.59
Work environment/equipment and physical strain	11	2.51	0.87	.73
Family circumstances	5	2.15	0.82	.61
Psycho-physical health status	4	2.29	0.82	.54
Personality traits	10	2.36	0.57	.59
Attitudes towards work	9	2.27	0.49	.43
Self-care	8	2.97	0.72	.57
Socio-demographic background	8	2.19	0.64	.63

Number of items on subscales ranged from 4 to 11. Answers on subscales Organizational culture and function and Work environment/equipment and physical strain were the most variable. The majority of subscales had a relatively low reliability estimates.

### Internal structure: Principal Component Analysis

PCA was conducted on risk factors category sums as to determine the content of specific factors. Using Direct Oblimin rotation, and retaining all components with eigenvalues >1, four-component solution emerged, explaining 69.9% of the total variance. It is characterized by (i) organizational context, (ii) socio-economic characteristics of the employee, (iii) job characteristics and (iv) individual characteristics of the employee (Table 3).

Table 3. Component Score Coefficient Matrix (Direct Oblimin rotation)

	Component			
	1	2	3	4
Variance (unrotated solution)	47.33	8.74	7.44	6.43
Variance (rotated solution)	36.81	22.74	26.85	23.66
Interpersonal relationship at work	<b>.27</b>	.01	<b>-.15</b>	-.02
Organizational culture and function	<b>.23</b>	-.05	.03	-.04
Organizational structure	<b>.21</b>	<b>-.15</b>	-.03	.07
Career development	<b>.22</b>	.01	-.02	-.02
Participation	<b>.21</b>	.03	.02	-.11
Family circumstances	-.07	<b>.43</b>	-.07	-.02
Home-work interface	.05	<b>.28</b>	.02	-.09
Socio-demographic background	.07	<b>.19</b>	-.10	.13
Role and responsibility in organization	-.09	-.11	<b>.39</b>	.07



Work schedule	-0.02	.04	<b>.36</b>	<b>-.15</b>
Workload/work pace	.08	-.14	<b>.25</b>	.05
Task design	.01	.12	<b>.22</b>	-.06
Work environment/equipment and physical strain	.02	<b>.22</b>	<b>.15</b>	-.12
Attitudes towards work	-.05	-.06	.01	<b>.45</b>
Personality traits	.03	-.04	-.09	<b>.40</b>
Self-care	-.02	-.01	<b>.15</b>	<b>.21</b>
Psycho-physical health status	-.05	<b>.22</b>	-.09	<b>.26</b>

Coefficients with an absolute value greater than or equal to .15 are shown in bold

Component Structure shows minimal cross-loadings and all four components present core groups of risk factors for workplace stress that have been consistently observed in studies of psychosocial risk factors at the workplace. The category Work environment/equipment and physical strain showed the highest weight of the regression factor scores on the second component (socio-economic characteristics of the employee). Nevertheless, it was retained on the third component (job characteristics) on theoretical basis. Categories Organisational structure, Self-care and Psycho-physical health status also showed comparable regression weights for predicting two components, but were retained on the components with the highest weights.

Component intercorrelations were moderate, with values ranging from .20 to .45 (see Table 4).

Table 4. Component intercorrelations

Component	1	2	3
1. Organizational context			
2. Socio-economic characteristics of the employee	.35		
3. Job characteristics	.43	.28	
4. Individual characteristics of the employee	.42	.21	.33

### Internal structure: Reliability

Composite reliability was calculated for each of the resulting four components, leading to general conclusion that scales have satisfactory reliability.

Table 5. Reliability estimates of the scales.

Component	Composite reliability	Corrected Item-Total Correlation
1. Organizational context	.93	
Interpersonal relationship at work		.73
Organizational culture and function		.84
Organizational structure		.64
Career development		.80
Participation		.74
2. Socio-economic characteristics of the employee	.80	
Family circumstances		.64
Home-work interface		.61
Socio-demographic background		.57



---

3. Job characteristics	.85	
Role and responsibility in organization		.53
Work schedule		.63
Workload/work pace		.63
Task design		.68
Work environment/equipment and physical strain		.57
4. Individual characteristics of the employee	.85	
Attitudes towards work		.67
Personality traits		.68
Self-care		.63
Psycho-physical health status		.55

---

The logo for 'iafor' is centered on the page. It consists of the lowercase letters 'iafor' in a light blue, sans-serif font. The text is enclosed within a circular graphic composed of two overlapping, thick, brush-stroke-like arcs. The upper arc is light blue and the lower arc is light red, creating a partial circular frame around the text.

## Discussion

Previous research (e.g. Kopp, et al. 2007; Leka, et al. 2003; Pološki Vokić & Bogdanić 2007) suggests that a number of work-related and non-work-related factors, including specific socio-demographic and cultural settings, could contribute to the experience of work-related stress. So far, there are no instruments for stress assessment available in Slovenia (Tabanelli, et al. 2008) that would be adapted to non-English-speaking cultural settings and would cover psychosocial risks at work as well as risks arising from broader non-work related environment. Therefore in the presented study a comprehensive instrument that covers a broad spectrum of risk factors associated with job stress and its adverse negative outcomes was developed and its psychometric properties were analyzed in a sample of Slovenian employees.

The development of the risk assessment tool underwent several phases, including a literature review, an expert panel, two consecutive rounds of an online survey and a validation of the tool in a pilot sample. The final version consisted of 130 items that were qualitatively divided into 16 categories of risk factors. PCA was used to summarize the information from a given set of risk factors. A four component solution consisted of most commonly identified groups of psychosocial risk factors that contribute to the experience of stress at the workplace (e.g. Kopp, et al. 2007; Leka, et al. 2003; Pološki Vokić & Bogdanić 2007). After the rotation (Direct Oblimin with Kaiser normalization), the first component Organisational context accounted for the highest proportion (36,81%) of unexplained variance, followed by the component Job characteristics (26,85%). Both components cover work-related risks that are mostly included into existing instruments for workplace stress assessment (Tabanelli, et al. 2008). Nevertheless, the remaining two components Individual characteristics of the employee and Socio-economic characteristics of the employee explain 23,66% and 22,74% of variance, respectively. Therefore our findings indicate that the role of non-work related risk factors should not be overlooked. Moreover, since the obtained components have satisfactory composite reliability, the four component solution seems to be appropriate from the reliability point of view as well.

We also need to note some potential limitations of our study. A first potential drawback concerns a rather specific sample, which has not been randomly selected from the full range of possible occupations. The majority of the sample consisted of employees in the public administration and defence, health care and social work and industry or manufacturing. This could be of a practical relevance, because research findings (Johnson, Cooper, Cartwright, Donald, Taylor & Millet 2005) indicate that experience of work-related stress differs across occupations. Moreover, our sample was overrepresented by employees from 31 to 50 years old, and by highly educated employees with either completed high school or university. Another drawback of our study is the reliance on self-report.

The study represents an important step toward the development of a comprehensive instrument for identifying potential risk factors associated with harmful work-related outcomes, taking into account also pertinent socio-cultural and health characteristics of Slovenia. Moreover, it provides insight into non-work-related risk factors that only recently gained more research attention and may contribute to the experience of work-

related stress. Further validation of the tool in different work settings and samples is needed.



## References

- Amstad, FT, Meier, LL, Fasel, U, Elfering, A & Semmer, NK 2011, 'A Meta-Analysis of Work–Family Conflict and Various Outcomes', *Journal of Occupational Health Psychology*, vol. 16, no. 2, pp. 151-169.
- Bergerman, L, Corabian, P & Harstall, C 2009, *Effectiveness of organizational interventions for the prevention of workplace stress*, Institute of Health Economic, Canada.
- European Agency for Safety and Health at Work, EU-OSHA 2010, *European Survey of Enterprises on New and Emerging Risks (ESENER) - Managing safety and health at work*, Office for Official Publications of the European Communities, Luxembourg.
- European Foundation for the Improvement of Living and Working Conditions, EUROFOND 2007, *Work-related stress*, European Foundation for the Improvement of Living and Working Conditions, Dublin.
- Eurostat 2011a, *Part-time employment as a percentage of the total number of employees for a given sex and age group*, European Commission: Luxembourg.
- Eurostat 2011b, *Temporary employees as a percentage of the total number of employees for a given sex and age group*, European Commission, Luxembourg.
- Fine, SA, & Cronshaw, SF 1999, *Functional job analysis: A foundation for human resources management*, Lawrence Erlbaum Associates, Mahwah.
- Graham, JW 2009, 'Missing data analysis: making it work in the real world', *Annual Review of Psychology*, vol. 6, pp. 549–576.
- Hlastan-Ribič, C, Djomba, JK, Zaletel-Kragelj, L, Maučec-Zakotnik, J & Fras, Z 2010, *Tvegana vedenja, povezana z zdravjem in nekatera zdravstvena stanja pri odraslih prebivalcih Slovenije - Rezultati raziskave Dejavniki tveganja za nenalezljive bolezni pri odraslih prebivalcih Slovenije 2008*, Inštitut za varovanje zdravja, Ljubljana.
- Johns, G 2003, 'How methodological diversity has improved our understanding of absenteeism from work', *Human resource management review*, vol. 13, no. 2, pp. 157-184.
- Johns, G 2010, 'Presenteeism in the workplace: A review and research agenda', *Journal of Organizational Behavior*, vol. 31, pp. 519–542.
- Johnson, S, Cooper, CL, Cartwright, S, Donald, I, Taylor, P & Millet, C 2005, 'The experience of work-related stress across occupations', *Journal of Managerial Psychology*, vol. 20, no. 2, pp. 178-187.
- Kopp, MS, Stauder, A, Purebl, G, Janszky, I & Skrabski, Á 2007, 'Work stress and mental health in a changing society', *European Journal of Public Health*, vol. 18, no. 3, pp. 238-244.
- Leka S, Griffiths, A & Cox, T 2003, *Work organisation and stress. Systematic problem approaches for employers, managers and trade union representatives. Protecting workers' health series, No. 3*, Geneva, World Health Organization.
- Maslach, C, Schaufeli, WB & Leiter, MP 2001, 'Job burnout', *Annual Review of Psychology*, vol. 52, pp. 397-422.
- Milczarek, M, Schneider, E & Rial Gonzalez, E 2009, *OSH in figures: stress at work — facts and figures*, European Agency for Safety and Health at Work, Luxembourg.
- Novak, T, Šprah, L & Fridl, J 2012. 'Assessment of well-being indicators at the regional level in Slovenia.' In *Overcoming and preventing stress in the*

individual & quality of life, well-being in urban areas: *Proceedings of the 1st Chance4Change International Conference*, ed. M. Mulej et al., Maribor.

- Parent-Thirion, A, Fernández Macías, E, Hurley, J & Vermeylen, G 2005, *Fourth European Working Conditions Survey*, European Foundation for the Improvement of Living and Working Conditions (EUROFOND), Dublin.
- Parent-Thirion, A, Vermeylen, G, van Houten, G, Lyly-Yrjänäinen, M, Biletta, I & Cabrita, J 2010, *Fifth European Working Conditions survey – 2010*, European Foundation for the Improvement of Living and Working Conditions (EUROFOND), Dublin.
- Pološki Vokić, N & Bogdanić, A 2007, *Individual differences and occupational stress perceived: a Croatian survey*, *E.F.Z.G Working Papers Series, 07-05*, University of Zagreb, Faculty of Economics and Business, Zagreb.
- Salavecz, G, Chandola, T, Pikhart, H, Dragano, N, Siegrist, J, Jöckel, KH, Erbel, R, Pajak, A, Malyutina, S, Kubinova, R, Marmot, M, Bobak, M & Kopp, M 2010, 'Work stress and health in Western European and post-communist countries: an East-West comparison study', *Journal of Epidemiology and Community Health*, vol. 64, no. 1, pp. 57-62.
- Sedlar, N, Novak, T & Šprah, L 2012a. 'Development of a risk assessment tool for adverse outcomes of occupational stress.' In *Proceedings of the 33rd International Conference of the Stress and Anxiety Research Society*, ed. A. Sese, Palma de Mallorca.
- Sedlar, N, Novak, T & Šprah, L 2012b. 'Burnout among Slovenian employees : a meta-analytic review of related variables.' In *Proceedings of the 10th Conference of the European Academy of Occupational Health Psychology*, ed. A. Jain, Zürich.
- Sedlar, N, Novak, T & Šprah, L 2012c. 'A preliminary study on a new risk assessment tool related to occupational stress' In *Overcoming and preventing stress in the individual & quality of life, well-being in urban areas: Proceedings of the 1st Chance4Change International Conference*, ed. M. Mulej et al., Maribor.
- Stauder, A, Konkoly, TB, Kovács, M, Balog, P, Williams, V & Williams, R 2010, 'Worldwide stress: different problems, similar solutions? Cultural adaptation and evaluation of a standardized stress management program in Hungary', *International Journal of Behavioral Medicine*, vol. 17, no. 1, pp. 25-32.
- Tabanelli, MC, Depolo, M, Cooke, RM, Sarchielli, G, Bonfiglioli, R, Mattioli, S & Violante, FS 2008, 'Available instruments for measurement of psychosocial factors in the work environment', *International Archives of Occupational and Environmental Health*, vol. 82, no. 1, pp. 1-12.
- WHO, Regional office for Europe 2005, *Mental health and working life*, WHO European Ministerial Conference on Mental Health, Helsinki.
- WHO, Regional Office for Europe, 2011, *European health for all database*. Available from: <http://data.euro.who.int/hfad/>. [20 May 2012].

*The Moderating Effect of Work Motivation and Coping Strategies on Job Satisfaction  
and Psychological Well Being among Fire Fighters*

Mohd. Dahlan Hj. A. Malek, Ida Shafinaz Mohd. Kamil

Universiti Malaysia Sabah, Malaysia

0231

The Asian Conference on Psychology & the Behavioral Sciences 2013

Official Conference Proceedings 2013

Abstract

Sources of occupational stress and their impact on work motivation, job satisfaction and well being were examined in a questionnaire survey of 436 UK fire fighters from four fire brigades. The role of coping strategies as a moderating factor was also tested. Levels of occupational stress had a significant negative correlation with job satisfaction. Multiple regression analysis was used to examine the moderating effect of work motivation and coping strategies on job satisfaction and psychological well being and found that there was a significant influence of coping behaviour as a moderating variable on job satisfaction. These findings provide some implications for the human resource department of the emergency workers to establish a counselling unit in order to deal with psychological problem faced by the emergency workers.

Keywords: Stress; Well being; Work motivation; Job satisfaction; Fire fighter



## 1. Introduction

Every year, fires and other emergencies take lives and destroy properties. Fire fighters help to protect the public against these threats by rapidly responding to emergency calls. In the course of their work, they can be exposed to physical, chemical and biological hazards. They also face the risk of psychological conditions such as post traumatic stress disorder (PTSD), resulting from witnessing traumatic events. In common with other less risky occupations, they can experience occupational stress relating to their work conditions (e.g. shiftwork) or other organisational or career issues.

While there is an extensive literature on stress in policing (e.g. Alexander & Walker, 1994; Brown, 2001; Kircaldy, Brown & Cooper, 1988), only a few empirical studies have systematically examined the causes and effects of stress in fire fighters' work. Most of these have concentrated on the specific effects of distressing events causing PTSD (Al-Naser & Everly, 1999; Corneil, 1993; Corneil, Beaton, Murphy, Johnson & Pike, 1999) rather than the more general issue of occupational stress and its effects. This article focuses on sources of stress as predictors of psychological well being (anxiety, stress and depression) and job satisfaction among UK fire fighters. It also examines the roles of work motivation and coping behaviour as moderators between exposure to occupational stressors and psychological well being/ job satisfaction.

### Causes and Effects of Occupational Stress in Firefighters

A fire fighter must be well prepared both physically and mentally, as fire fighting and emergency rescue work is a very challenging and high-risk job. According to Leigh (1988), professional fire fighting is a stressful and dangerous occupation that ranks fifth in occupational mortality in the United States. Evidence suggests that most fire-fighter mortality and morbidity is related either directly or indirectly to the stressful nature of their work (Beaton & Murphy, 1993). Furthermore, Moran (2001) found that workers in emergency service organisations such as the fire brigade, ambulance service and rescue squads, are not only exposed to everyday stressors common to many work environments, but they can also face extreme stressors associated with emergency incidents such as traumatic accidents or disasters. Beaton and Murphy (1993) suggested that fire fighters' job stress is complicated and multifaceted. They developed the Sources of Occupational Stress Scale that divided the sources of occupational stress among fire fighters into 14 factors, namely sleep disturbance, job skill concerns, past critical incidents, management conflicts, apprehensions regarding personal safety, co-worker conflict, substandard equipment, reduction in force, wage and benefit worries, conveying news of tragedy, tedium, poor health habits, discrimination, family or financial strain and second job stress. Based on their study, they found that the SOOS instrument appears to have adequate reliability and concurrent validity for the fire fighters and correlated with job satisfaction and work outcomes. Results from Baker and Williams (2001) study on 78 UK fire fighters indicated that work stress (i.e. organisational stress and incident-related stress) and problem-solving appraisal accounted for 49% of the variance in psychological distress. They found that those reporting higher level of psychological distress also reported less confidence. They also found that individuals in different fire service ranks reported similar levels of organisational stress. Young and Cooper (1997) found that

poor physical health was a major stress outcome among 427 emergency service workers (fire service and ambulance services) in England. The results of the study present a picture of occupational stress, its sources and effects for both public services. The results also show that job dissatisfaction was revealed as a major problem for the ambulance service and fire service workers. Bartolo and Furlonger (2000) also investigated job satisfaction but they focused on the relationship between job satisfaction and supervisor leadership behaviour among fire fighters. In their study, the sample was selected from a privatised aviation fire service in Australia and consisted of 56 fire fighters from two stations in Victoria (n=36) and New South Wales (n=20). They used a shortened version of the Smith et.al. (1969) Job Description Index (JDI) to measure job satisfaction and the Leader Behaviour Questionnaire version 12 (LBQXII) to measure employees' perception of their superiors' leadership. The results indicated that there are significant positive relationships between co-worker satisfaction, supervision satisfaction, initiating structure and consideration leadership behaviour.

Beaton & Murphy (1993) reported that, social support at home (with family and friends) was significantly higher than satisfaction with co-worker support and low social support and / or high relational conflict (especially work) may predict adverse health outcomes among 1,703 fire fighters and 253 paramedics U.S. sample.

Other studies, Lusa, Hakkanen, Luukkonen & Viikari-Juntura (2002) examined 543 male fire fighters and rescue workers from 71 Finland fire brigades by using a cross-sectional questionnaire study. The result of their study found that the fire fighters working during the strike reported more stress than those in normal situations. However, they found that their first study conducted about perceived physical work capacity, stress, sleep disturbance and occupational accidents among Finish fire fighters during the normal situation were at the same level as compared to their second study of the Finish fire fighters work during a strike. Previous studies suggested that work motivation (Ambrose & Kulik, 1999; Deci & Ryan, 1985; Lou Lu, 1999) and coping (Moran & Colles, 1995) are the important variables predicting psychological well being.

#### Work motivation and coping strategies

Pinder (1998) described work motivation as a set of internal and external forces that initiate work-related behaviour; determine its form, direction, intensity and duration. It can be defined as the willingness to exert high levels of effort toward organisational goals, conditioned by the person's ability to satisfy some individual need. Given the risks, fire fighters' motivation and job satisfaction must be high for them to stay in this occupation. Thus, job satisfaction may play an important role for fire fighters in increasing their job performance. When a fire fighter has high motivation, this will perhaps improve his or her job satisfaction and psychological well being. In this study, work motivation was divided into three components, accomplishment striving, status striving and communion striving based on Barrick et.al (2002) study on the effect of motivation among sales representatives. Beaton et al. (1999) reported that fire fighters must cope with extraordinary and persistent occupational demands that are potential cumulative

Besides that this study will examine the types of coping behaviour used by UK fire fighters. The ability to cope with demands is very important in our lives. People

adapt in different ways to the environment and these differences can influence the level of psychological well being. Moran (2001) reported that appraisal of coping behaviour is a complex phenomenon that can also involve expectations about how one will be affected and deal with future stressors. She suggested that the coping style of emergency workers could result from the type of work, rather than type of person. For example, emergency workers frequently describe their reactions at an emergency or disaster site in terms similar to the following: “we have a job to do and we have to get on with it. We can’t afford to be upset by the things around us” (p.357). Lindy (1985) stated that this type of coping has been referred to as a “trauma membrane” that allows emergency workers to shield themselves emotionally from unpleasant or threatening scenarios.

The purposes of the study are: (a) to examine the sources of stress as a predictor of psychological well being (anxiety, stress and depression) and job satisfaction among UK fire fighters and (b) to examine the roles of work motivation and coping behaviour as moderator variables. The current study will be based on the proposed theoretical framework outlined below in Figure 1. This theoretical framework of the study is based on the review of literature on fire fighters, proposed by Malek, Mearns & Flin (2003).

[Insert Figure 1 about here]

In this model, sources of stress are related to job satisfaction and psychological well being, and moderated by the work motivation and coping behaviour.

#### 1.4. Hypotheses of the Study

On the basis of the foregoing overview, the following hypotheses were formulated:

##### *Hypothesis 1*

It is predicted that fire fighters who report higher levels of pressure arising from sources of stress report lower job satisfaction and poorer psychological well being.

##### *Hypothesis 2*

Work motivation and coping behaviour act as moderating variables between sources of stress and psychological well-being (anxiety, stress and depression) and job satisfaction.

## **Method**

### **Procedure**

The questionnaire was distributed through the officers in charge in four fire brigades in the UK. Questionnaires were sent to each station via the internal post of each brigade and were then distributed to individual members. At the time of distribution, the purpose of the survey was explained and the feedback that could be expected was described. All personal information given was treated in confidence, and no individual was identifiable. Ethics approval for the study was granted by the School of Psychology Research Ethics Committee that adheres to British Psychological Society guidelines.

## Measures

Respondents completed a self-report questionnaire containing five scales measuring sources of stress, work motivation, coping strategies, psychological well being and job satisfaction. Respondents were also asked for demographic information (age, length of service, marital status, job position and second job). Details of each scale are given below.

*Sources of Stress.* Sources of stress were measured with the Sources of Occupational Stress in Fire Fighters & Paramedics (SOOS; Beaton & Murphy, 1993). The SOOS has 57 items designed to assess the types and degrees of psychosocial stressors to which fire fighters are commonly exposed. The respondents were asked to indicate whether they had experienced a particular type of occupational stressor within their past 10 work shifts and if they had, to indicate how 'bothered' they had been by this job-related stressor on a 1 to 10 rating scale (where 10=extremely bothered, 5=somewhat bothered, and 0=not bothered at all). Beaton and Murphy (1993) found that the overall Cronbach's  $\alpha$  of the SOOS was 0.95 (n=2005) for US fire fighters. The scale was chosen for UK fire fighters since it appears to be comprehensive and relevant for UK fire operations (Coefficient  $\partial$  for the present study was 0.97).

*Work motivation.* Work motivation was measured with The Motivational Orientation Inventory (MOI; Barrick et al., 2002). The MOI has 31 items and it is suitable for measuring three aspects of motivation. In fact, all the items have been customized for fire fighters. Accomplishment Striving (AS, 11 items), reflects an individual's intention to accomplish task and is characterized by a high task orientation (e.g. I frequently think about getting my work done). Communion Striving (CS, 8 items) represents action directed towards obtaining acceptance in personal relationships and getting along with others at work (e.g. I focus my attention on being the best fire fighter in the station). Status Striving (SS, 12 items) represents actions directed toward obtaining power and dominance within a status hierarchy at work (e.g. I care a lot about having co-workers and supervisors who are like me). Respondents indicated their level of agreement with each item on a 5-point scale (5=strongly agree, 4=agree, 3=not really sure, 2=disagree and 1=strongly disagree). Barrick et al. (2002) report Cronbach alphas of 0.91, 0.89 and 0.78 for the three sub scales (AS, SS, CS), based on a sample of 1130 university students. Coefficient  $\partial$  for the overall of the MOI in present study was .93. The MOI was chosen in the present study since the results of the pilot study showed that the instrument had good internal reliability and was suitable for use with the Malaysian fire fighters (Cronbach's alpha .88).

*Coping strategies.* Coping strategies were assessed with the Coping Response of Rescue Workers Inventory (CRRWI) that contain a 32 item scale developed by Corneil (1993) to measure coping behaviours among fire fighters. The CRRWI initially developed from The Ways of Coping Inventory, which originally contained 68 items describing a broad range of behavioural and cognitive strategies that an individual might use in stressful situations. According to Corneil (1993) this instrument has been slightly reworded and shortened into 32 items by Horowitz and Wilner (1981) for use with disaster victims. Mc Cammon, Durham, Allison et al (1988) used factor analysis to obtain the four sub scales: appraisal-focused coping (search for meaning); problem focused coping (regaining mastery through individual action); emotional-focused coping (regaining mastery through interpersonal action); and self-esteem (philosophical and self-contemplation). Corneil, (1993) adapted 32



items that shortened by Horowitz and Wilner (1981) and used in his studies on Canadian fire fighters but he categorised the items into 6 components; Cognitive Appraisal, Emotion Focus; Seeking Social Support; Behaviour Change; Denial; and Philosophical Self-Contemplation. However, Beaton et al (1999) in a study on coping responses and post traumatic stress symptomatology in US urban fire service personnel categorised the Coping Response of Rescue Workers Inventory (CRRWI) into new components namely: Secondary appraisal in aftermath; Behavioural distraction & social support seeking; Cognitive behavioural avoidance and numbing; Foster positive attitudes; Cognitive positive self-talk; and Inward search-philosophical Self-contemplation. The CRRWI is suitable for measuring coping behavior in the current study since it has already been used in a sample of fire fighters. The version of CRRWI used here contained 32 items and respondents indicated how frequently they use the ways to handle stress with each item on a 4-point scale (1=never, 2=rarely, 3=sometimes, 4=often). Some examples include "Be more helpful to others," "Turn to religion or philosophy for help," and "Put feelings out of my mind." The coefficient  $\alpha$  for sub scales of the CRRWI was in the range .61 to .85 and the total coefficient  $\alpha$  was .90 (Beaton et al,1999)

*Psychological well being.* This was measured with the Psychological Well being Scale (PWS). The PWS is a 36 item scale adapted from three instruments namely, 12 items from the Clinical Anxiety Scale (CAS; Thyer, 1992) to measure level of anxiety (e.g. I feel calm), 12 items from the Index of Clinical Stress (ICS; Hudson & Abell, 1992) to measure level of stress (e.g. I feel over panicky) and 12 items from the Generalized Contentment Scale (GCS; Hudson, 1993) to measure level of depression (e.g. I feel downhearted). Respondents indicated their degree of agreement with each item on a 4-point scale (1=never, 2=rarely, 3=sometimes, 4=often). The PWS was used in the current study since it has been shown to have high reliability (.88). The reliability of the overall PWS for the UK fire fighters was .86

*Job satisfaction.* This was measured with The Job Satisfaction Scale developed by Warr, Cook and Wall (1979). The JSS was deemed to be suitable for this study as it is simple and precise and measures overall, as well as intrinsic and extrinsic job satisfaction. According to Mullarkey, Wall, Warr, Clegg and Stride (1999) the JSS has been used with a wide range of employees including those working in primary health care, shop floor manufacturing jobs, education, public service, construction work and off-shore oil installations. Respondents indicated their degree of satisfaction with each item on a 7-point scale (1=I'm extremely dissatisfied, 2=I'm very dissatisfied, 3=I'm moderately dissatisfied, 4=I'm not sure, 5=I'm moderately satisfied, 6=I'm very satisfied, 7=I'm extremely satisfied). The Cronbach's alpha coefficients for each factor show high reliability, for example for overall satisfaction (manufacturing, n=6579 the Cronbach's alpha is 0.92), for intrinsic satisfaction (manufacturing, n=6583, the Cronbach's alpha is 0.88) and for extrinsic satisfaction (manufacturing, n=6590, Cronbach's alpha is 0.83) (Mullarkey et.al. 1999). The Intrinsic Job satisfaction sub scale comprises seven items (e.g. The freedom to choose your own method of working?) and the Extrinsic Job Satisfaction sub scale was made up of eight items (e.g. your rate of pay?). Coefficient  $\alpha$  for the present study was .89 for the overall job satisfaction, .80 for the external job satisfaction and .84 for the internal job satisfaction.

## Respondents

Questionnaires were distributed to 1042 personnel with 436 returned from fire fighters (all male) in operational units (42% response rate). Responses were obtained from all ranks, 324 full time fire fighters and 112 retained fire fighters. The length of the respondents' service ranged from less than one year (4%, n=16) to more than 10 years (58%, n=251). The age of the respondents ranged from 21 to 60 years old and the majority were in the range between 36 to 40 years old.

## 3. Results

### 3.1. Descriptive statistics

Descriptive statistics for all variables are presented in Table 1. Included are means, standard deviation and coefficient alphas. The results show that the internal reliabilities of measures are acceptable. The Cronbach's alphas ranged from 0.86-0.93.

### 3.2. Correlations

Intercorrelations among sources of stress, work motivation, psychological well being, coping strategies and job satisfaction are also presented in Table 1. The results indicated that the total of sources of stress had a significant negative correlation with job satisfaction ( $r = -.35, p < 0.01$ ). The results also indicated that the total of sources of stress had a significant positive correlation with psychological well being ( $r = .38, p < 0.01$ ). In other words, the higher levels of pressure arising from sources of stress, the lower job satisfaction and the poorer psychological well being among UK fire fighters. Therefore, hypothesis 1 is supported by the findings.

[Insert Table 1 about here]

### 3.3. Regression analyses on the total of job satisfaction and psychological well being

#### 3.3.1. Job satisfaction

Multiple regression analysis with 'Enter' method was used to examine the extent of the influence of the overall coping behaviour and the overall work motivation on the interaction between sources of stress, well being (anxiety, stress and depression) and job satisfaction. Coefficient  $R^2$  is used to measure the contribution of psychological well being (anxiety, stress and depression), meanwhile value change of  $R^2$  is used to see the contribution of coping behaviour and work motivation.

The results in Table 2 shows that overall coping behaviour had a significant influence on overall job satisfaction (Beta = 1.22,  $p < .000$ ) but not on work motivation (Beta = .40,  $p < .10$ ). Therefore, there was a significant influence of coping behaviour as a moderating variable on job satisfaction.

[Insert Table 2 about here]

#### 3.3.2. Psychological well being

The results in Table 3 also indicated that the overall coping behaviour (Beta = .108,  $p < .745$ ) and overall work motivation (Beta = -.004,  $p < .98$ ) were not a significant influence on well-being. Finally, it was found that all the six components of coping behaviour and all three components of work motivation did not make a significant contribution towards well being. Therefore the hypothesis that work motivation makes a contribution to psychological well being and job satisfaction was not



supported. Only coping behaviour contributes to job satisfaction among UK fire fighters.

[Insert Table 3 about here]

## 4. Discussion

### 4.1. Overview

The overall aim of this study was to examine the relationship of sources of stress, job satisfaction and well being among UK fire fighters. First the result was found to be consistent with Beaton and Murphy (1993), where the total Source of Stress scale was found to have a significant negative correlation with job satisfaction. The present finding also showed that the “Past critical incidents” component was the top ranked for the source of stress among British fire fighters, whereas the lowest component was “Discrimination”. This finding was different from the norm data of the US fire fighters where the top ranked of the SOOS was “Sleep disturbance”. However the lowest ranked item was similar to the norm data of US fire fighters. Besides that the results indicate that the item ‘Reduction in force, manpower, wages, and/or benefits; real or threatened’ achieved the top ranked score and the lowest ranked mean score for the SOOS was the item ‘Harassment based on gender, ethnicity, or age. The results present a picture of sources of stress in UK fire fighters, which is different to that in other countries for example U.S., Canada, Finland and Malaysian fire fighters. UK fire fighters also reported high levels of depression compared to levels of anxiety and levels of stress (which was lowest). Compared to other studies, e.g. in female pensioners (Adi, Malek & Haji-Yusuf, 2002), levels of anxiety and depression among UK fire fighters can be considered at an intermediate level; but levels of stress which can be considered lower (12-23=lower, 24-35=intermediate and 36-48=high). The overall well being of the UK fire fighters was also intermediate to the maximum score (Min=36, Max=144).

The results indicated that the mean score for the sub scale ‘Accomplishment Striving’ was higher than for other two compared to the sub scale ‘Status Striving’ and ‘Communion Striving’. Our results also suggested that there is a significant positive correlation between communion striving, status striving and accomplishment striving and overall job satisfaction. The results are consistent with Barrick et.al. (2002) who suggested that accomplishment striving may affect performance through communion and status striving. In fact our results suggested that there is a significant relationships between accomplishment striving and job satisfaction but not between accomplishment striving and psychological well being among UK fire fighters.

The result also indicated that overall coping behaviour has a significant influence on overall job satisfaction but not on work motivation, which means that there is a significant influence of coping behaviour as a moderating variable on job satisfaction. This finding also found that ‘Foster positive attitudes’ was the most frequently used coping strategy by the UK fire fighters. This finding was different from a previous study by Corneil (1993) which found that ‘Secondary appraisal in the aftermath’ was the most frequently used coping strategy by Canadian fire fighters. Furthermore, these results corroborated a previous study (Lou Lu, 1999), which suggested that coping strategies are one of the potential moderating variables between sources of stress, well being and job satisfaction. However this study did not agree with Lou Lu (1999) that

work motivation is also one of the potential moderating variables. The study of how the fire fighters cope their stress at work is very important since Lusa et al (2002) reported that the opportunities to study how fire fighters cope their stressful situation are rare. Our results suggested that the ways which fire fighters cope with their stressful work situation at work are more important than how motivated they are.

#### 4.2. Limitations and implications

Finally, there are several limitations to this study. First, the data were self-reported responses and were based on a fire fighters sample only. Therefore, it is not possible to extrapolate these finding to other occupational groups, including other emergency services. Second, this study did not deal with long-term outcomes since the respondents were asked to indicate whether they had experienced a particular type of occupational stressor within their past 10 work shifts only. Third, there is also a disadvantage in using a questionnaire design, namely that one cannot get all the data or information required, as it is very specific and very focused. Goddard III and Villanova (1996) have stated that, a limitation of questionnaires is that the items are preset and respondents cannot fully express their opinions. However, after some consideration, the study still used a questionnaire design because of time constraints and it is difficult to collect a great deal of specific information from a large number of fire fighters in a very short period and given these constraints a questionnaire seemed the best option. Furthermore, a number of scales had been developed for use with fire fighters investigating the variables that we interested in. Fourth, the study was conducted after industrial action had occurred in the UK.

Despite the limitations mentioned, this study has potential implications for fire fighters' stress management programmes. It is suggested that UK fire fighters can identify the best strategies to cope with their stress. Perhaps model of psychological well being will give some guidelines such as which ways are the most frequently used by UK fire fighters to managing stress at work, and tried to identified which ways are suit them. For example one way to classify interventions intended to help people deal with emergency situation is to consider the level of control available to the fire fighters at that time. Moreover, the strategies for dealing with either stressors or strain outcomes ultimately require individual awareness, commitment, knowledge, skill and participation in emergency situations. In other words, the utility of stress knowledge and related skills ultimately rest in the hands of the fire fighters who are stressed and in their ability to apply their knowledge in order to cope with certain situation.

In conclusion, fire fighters' job satisfaction must be high for them to stay in this occupation. Thus, job satisfaction plays an important role for fire fighters in increasing their job performance. When a fire fighter has the best strategies to cope with stress, this will perhaps improve job satisfaction and psychological well being. However, its depend on the individual because the people are difference as Lusa et al (2002) reported that the work of fire fighters is largely based on the co-operation between them and can be problematic with individuals having different kinds of back ground such as education.

## References.

- ADI, F, MALEK, MD. & HAJI-YUSUF, M. (2002). Sources of stress, coping strategies and well being among female pensioners. Research Report. Psychological Research and Social Health Unit, University Malaysia Sabah.
- AL-NASER F. & EVERLY G. (1999). Prevalence of posttraumatic stress disorder among Kuwaiti fire-fighters. *International Journal of Emergency Mental Health*, 1(2), 99-101.
- ALEXANDER, D.A., & WALKER, L.G. (1994). A study of methods used by Scottish police officers to cope with work-induced stress. *Stress Medicine*, 9, 131-138
- AMBROSE, M.L, & KULIK, C.T. (1999). Old friends, new faces: Motivation research in the 1990s. *Journal of Management*, 25 (3), 231-293.
- BARRICK, M. R., STEWART, G. L., & PIOTROWSKI, M. (2002). Personality and job performance: Test of the mediating effects of motivation among sales representatives. *Journal of Applied Psychology*, 87, 43-51
- BAKER, S.R. & WILLIAMS K. (2001) Short communication: Relation between social problem-solving appraisals, work stress and psychological distress in male fire fighters. *Stress & Health: Journal of the International Society for the Investigation of Stress*, 17(4), 219-229.
- BARTOLO K. & FURLONGER B. (2000) Leadership and job satisfaction among aviation fire fighters in Australia. *Journal of Managerial Psychology*, 15(1), 87-97.
- BEATON, R.D, & MURPHY, S.A. (1993). Sources of occupational stress among fire-fighter/EMT's and fire-fighter/paramedics and correlations with job-related outcomes. *Prehospital & Disaster Medicine*, 8, 140-150.
- BEATON, R.D., MURPHY, S.A. (1997). Social support and network conflict in fire fighters and paramedics. *Western Journal of Nursing Research*, 19 (3), 297.
- BEATON, R.D., MURPHY, S.A., JOHNSON C., PIKE K., & CORNEIL W. (1999) Coping responses and posttraumatic stress symptomatology in urban fire service personnel. *Journal of Traumatic Stress*, 12 (2), 293-307
- BROWN, J. & HEIDENSOHN, F. (2001). *Gender and Policing: Comparative Perspectives*. New York: St. Martin's Press.
- CLOHESSY S & EHLERS A. (1999) PTSD symptoms, response to intrusive memories and coping in ambulance service workers. *British Journal of Clinical Psychology*. (38), 251-265.

- CORNEIL W., BEATON R., MURPHY S., JOHNSON C. & PIKE K. (1999) Exposure to traumatic incidents and prevalence of posttraumatic stress symptomatology in urban fire fighters in two countries. *Journal of Occupational Health Psychology*. 4 (2), 131-141.
- CORNEIL W. (1993). Prevalence of posttraumatic stress disorder in metropolitan fire department. Unpublished doctoral dissertation, Johns Hopkins School of Hygiene & Public Health, Baltimore, Maryland.
- DECI, E. L. & RYAN, R. M. (1985). *Intrinsic motivation and self-determination in human behaviour*. New York : Plenum Press.
- GODDARD III, R.D., & VILLANOVA, P. (1996) Designing surveys and questionnaires for research. In F. Leong, & J.T. Austin, (eds.) *The Psychological Research Handbook: A Guide for Graduate Students and Research Assistants*. London: Sage.
- HOROWITZ, M., WILNER, N.J, & ALVAREZ, W. (1979). Impact of events scale: A measure of subjective stress. *Psychosomatic Medicine* 41(3), 209-218
- HOROWITZ, M. & WILNER, N.J. (1981). Life Events and Coping. In L. Poon (ed). *Aging in the 80's*. Washington, D.C.: American Psychological association.
- THYER (1992) *The Clinical Anxiety Scale (CAS)*. Tempe, Arizona: WALMYR Publishing.
- HUDSON, W. (1993) *The Generalized Contentment Scale (GCS)*. Tempe, Arizona: WALMYR Publishing.
- HUDSON, W. & ABELL, N. (1992) *Index of Clinical Stress (ICS)*. Tempe, Arizona: WALMYR Publishing.
- KIRCALDY, B., BROWN J. & COOPER, C. (1988) The demographics of occupational stress among police superintendents. *Journal of Managerial Psychology*, (13) 90-101
- LEIGH, J.P. (1988) *Job Related Deaths in 347 Occupations*. San Jose: San Jose University.
- LINDY, J. (1985). The trauma membrane and other clinical concepts derived from psychotherapeutic work with survivors of natural disasters. *Psychiatric Annals*, (15) 153-160.
- LOU LU (1999) Work motivation, job stress and employee well-being, *Journal of Applied Management Studies*. 8(1), 61.
- LUSA S., HAKKANEN M., LUUKKONEN R. & VIKARI-JUNTURA E. (2002) Perceived physical work capacity, stress, sleep disturbance and occupational accidents among fire fighters working during a strike. *Work & Stress*, 16 (3), 264-274.

- MALEK M.D., MEARNS, K. & FLIN, R. (2003). Stress and well being in fire fighters : A review of the literature. *Fire Safety, Technology & Management*, 8(2) 1-6.
- MCCOMMON, S., DURHAM, T.W., ALLISON, E.J. & WILLIAMSON, J.E. (1998) Emergency Workers Cognitive Appraisal and Coping With Traumatic Events. *Journal of Traumatic Stress*, 1, 353-372.
- MORAN, C. (2001) Personal predictions of stress and stress reactions in fire fighter recruits. *Disaster Prevention and Management*, 10 (5), 356-365.
- MORAN, C. & COLLESS, E. (1995) Positive reactions following emergency and disaster responses. *Disaster Prevention and Management*, 4(1), 55-60.
- MULLARKEY, S., WALL, T., WARR, P., CLEGG, C., & STRIDE, C. (1999). *Measures of Job Satisfaction, Mental Health and job-related Well-Being; A bench marking Manual*. Sheffield: Institute of Work Psychology.
- NIXON, S., SCHORR, J., BOUDREAUX, A. & VINCENT, R. (1999) Perceived sources of support and their effectiveness for Oklahoma City fire-fighters. *Psychiatric Annals*, 29(2) 101-105.
- PINDER, C.C.(1998) *Work motivation in organizational behavior*. Upper Saddle River, N J: Prentice-Hall.
- WARR, P.B., COOK, J.D. AND WALL, T.D. (1979). Scales for the measurement of some work attitudes and aspects of psychological well-being. *Journal of Occupational Psychology*, 52, 129-148.
- YOUNG K.M. & COOPER C.L. (1997) Occupational stress in the ambulance service: A diagnostic study. *Health Manpower Management*. 23 (4), 140-147.

**Figure 1: The theoretical framework for the study**

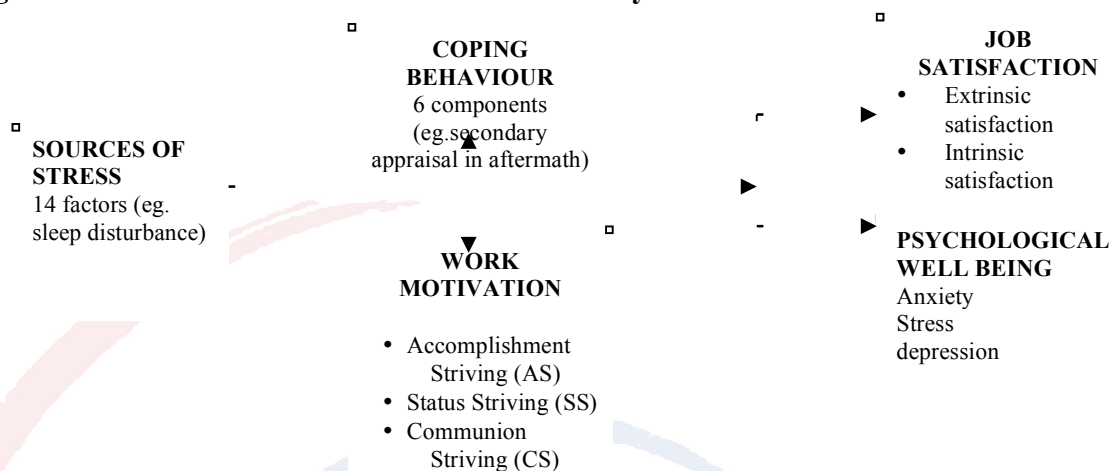

Table 1: Means, Standard Deviation, Cronbach's alpha and Pearson Correlation Coefficients of the study

Variable	M	SD	$\alpha$	1	2	3	4	5
1 Total of Sources of stress	120.7	102.9	.97	-				
2 Total of Work motivation	96.5	19.1	.93	.02	-			
3 Total of Coping behaviour	83	14.2	.90	.21**	.29**	-		
4 Total of Psychological Well being	76.6	12.2	.86	.38**	.03	.33**	-	
5 Total of Job satisfaction	66.6	13.5	.89	-.35**	.22**	.12*	-.07	-

\*p<.05; \*\*p<.01



Table 2: Multiple Regression of Coping Behaviour and Work Motivation on dependent variable (Job Satisfaction)

Step	1	2	3
<b>Overall coping behaviour- (CB)</b>			
R <sup>2</sup>	.112	.168	.200
R <sup>2</sup> Change	.124	.044	.032
Sing. F Change	.000	.000	.000
Constant	-	-	-
Beta Sources of stress [SOOS]	-.352	-.399	-1.5
Beta Coping behaviour [CB]	-	.215	.024
Beta Sources of stress x Coping-behaviour [SOOS x CB]	-	-	1.22**
<b>Work Motivation (WM)</b>			
R <sup>2</sup>	.125	.213	.219
R <sup>2</sup> Change	.127	.086	.006
Sing. F Change	.000	.000	.109
Constant	-	-	-
Beta [SOOS]	-.357	-.368	-.749
Beta [WB]	-	.294	.199
Beta [SOOS x WB]	-	-	.403

\*p<.05; \*\*p<.01

Table 3: Multiple Regression of Coping Behaviour and Work Motivation on dependent variable (Well Being)

Step	1	2	3
<b>Overall coping behaviour- (CB)</b>			
R <sup>2</sup>	.155	.219	.219
R <sup>2</sup> Change	.158	.061	.000
Sing. F Change	.000	.000	.745
Constant	-	-	-
Beta Sources of stress [SOOS]	.397	.345	.243
Beta Coping behaviour [CB]	-	.252	.236
Beta Sources of stress x Coping-behaviour [SOOS x CB]	-	-	.108
<b>Work Motivation (WM)</b>			
R <sup>2</sup>	.158	.160	.000
R <sup>2</sup> Change	.158	.003	.000
Sing. F Change	.000	.295	.987
Constant	-	-	-
Beta [SOOS]	.397	.395	.399
Beta [WB]	-	.052	.053
Beta [SOOS x WB]	-	-	-.004

\*p<.05; \*\*p<.01

*An Exploratory Study of Core Competencies in Psychological Assessment —A Taiwan Perspective*

Yu-Ling Lan<sup>\*1</sup>, Yuhsuan Chang<sup>\*2</sup>

<sup>\*1</sup>National Dong Hwa University, Taiwan, <sup>\*2</sup>Yuan Ze University, Taiwan

0239

The Asian Conference on Psychology & the Behavioral Sciences 2013

Official Conference Proceedings 2013

Abstract

Psychological assessment is regarded as one of the eight key competence domains at the 2002 competency conference in the U.S. (Kaslow et al., 2004). After discussion during this conference, Krishnamurthy et al. (2004) proposed an eight-factor model that included eight competencies essential to good practice in psychological assessment. The purpose of this research was to explore the underlying structure of competence in psychological assessment in Taiwan. This research consisted of Study 1 and 2. In Study 1, 46 clinical psychologists were recruited to have a 1.5~2-hour interview. Eighty-four competency indicators were extracted from these interview data. Over half of these indicators could be grouped into one of the eight-factor model proposed by Krishnamurthy et al. The others not included in the eight-factor model were grouped into five different domains to represent some foundational competencies for professional practice in psychological assessment.

To explore the underlying factor structure of competence in psychological assessment in Taiwan, the Chinese version of the psychological assessment competency (C-PAC) scale was developed for data collection. In Study2, 235 psychologists in Taiwan were asked to respond to the C-PAC scale. The exploratory factor analysis on this Taiwan psychologist sample revealed a ten-factor model that explained 67.44% of the total variances. The Cronbach's alpha values of these ten factors ranged from 0.51 to 0.90. Findings of this research provided a culturally relevant framework for measuring psychological assessment competency in Taiwan.

Keywords: psychological assessment, professional development, competency-based assessment, instrument development

## Introduction

Psychological assessment has been regarded as one of the main characteristics in clinical psychology (Groth-Marnat, 2000; Krishnamurthy et al., 2004; Piotrowski & Zalewski, 1993) over decades. Comparing with other health-related professionals, clinical psychologists have better education and training in assessment that allow them to use various psychological tests and assessment skills to facilitate psychological diagnosis and treatment plan (Krishnamurthy et al., 2004). In terms of clinical practice, Watkins (1991) mentioned, "...most practicing psychologists, regardless of work setting, provide assessment services and spend a fair portion of their professional time doing so" (p. 431). Assessment was also found to be one of the three most important clinical activities in Meyer et al. (1998) and Hsu, Huang, and Cheng's (2009) survey research. When examining advertisements for clinical psychological positions, many of them highly emphasized capability in assessment (Kinder, 1994). Competency in psychological assessment seems to be an essential requirement for clinical psychologists in their daily practice.

How to prepare students with competency in psychological assessment has become a major concern for graduate programs to reconstruct their assessment courses as well as training activities. Professional psychology has shifted their training models from normative to criterion-related perspective and uses "competence" as a standard to train and evaluate professional psychologists from entry to practice (Fouad et al., 2009).

## Definition of Psychological Assessment Competence (PAC) & its Hypothesized Components

What is competence? Epstein and Hundert (2002) have defined "competence" as "the habitual and judicious use of communication, knowledge, technical skills, clinical reasoning, emotions, values, and reflection in daily practice for the benefit of the individual and community being served" (p. 226). Competence seems to imply performance at an acceptable level, and can be conceptualized as an integrated concept that consists of knowledge, skills, and attitudes (Kaslow et al., 2004).

In November 2002, the Association of Psychology Postdoctoral and Internship Centers (APPIC) co-sponsored the *Competencies Conference: Future Directions in Education and Credentialing in Professional Psychology* in Scottsdale, Arizona (Kaslow et al., 2004). At this competencies conference, delegates from the U.S., Canada, and Mexico, with diverse training, education, and credentials, worked as groups to promote conversations to reach consensus on areas of competency.

At this conference, psychological assessment was proposed as one of the eight core competence areas. Based on consensus among psychology representatives in the psychological assessment workgroup, psychological assessment competency (PAC) was conceptualized under the competency-based perspective to include eight essential components (Krishnamurthy et al., 2004). Table 1 displays eight components generated from the group consensus at this competencies conference.

Table 1. Core Components of Psychological Assessment Competency (PAC)

Eight core components generated from the 2002 competencies conference
1. Knowledge of psychometric theory
2. Knowledge of psychological assessment
3. Knowledge of various psychology theories (cognitive, affective, behavioral, personality, ...)
4. The ability to evaluation treatment outcomes
5. The relationships b/w clients and psychologists
6. The ability to establish and maintain professional relationship
7. The relationship b/w assessment and intervention
8. Technical assessment skills

These components provided a theoretical framework for assessing psychological assessment in a competency-based perspective. Krishnamurthy et al. (2004) also mentioned, “ The preceding list of core competencies is provided in global terms in order to underscore the major ingredients of psychological assessment competency. Further specificity could be achieved in each of the eight areas.” (p. 733).

To develop a competency-based scale to measure PAC, we need to explore the underlying structure of PAC in the competency-based perspective. Meanwhile, due to differences between the U.S. and Taiwan in the design of professional education (i.e., doctoral level vs. master level), the competencies expected of clinical psychologists in Taiwan might be different from what in the U.S. To answer this question, we conducted a qualitative study first to understand Taiwanese psychologists’ perspective of the PAC in order to determine the appropriateness of applying the PAC theoretical framework proposed by Krishnamurthy et al. (2004) on clinical psychologists in Taiwan.

### **Purpose of the Present Study**

The purpose of the present study was twofold: (1) to conceptualize PAC from the Taiwan clinical psychologists’ perspective in order to develop the Chinese version of the PAC (C-PAC) scale to assess clinical psychologists in Taiwan, and (2) to examine the psychometric properties of the C-PAC scale in Taiwan. Sample 1 was used to explore the PAC theoretical structure in Taiwan in order to generate an initial item pool for developing the C-PAC scale. Sample 2 was used to investigate the underlying factor structure of the C-PAC in Taiwan as well as its psychometric properties.

## Method

### Participants

Two independent samples of clinical psychologists from health-care institutions, private practice, and clinical psychology programs in Taiwan were recruited on a voluntary basis in 2009. Sample 1 consisted of 46 clinical psychologists. More than 86% of them had a master or doctoral degree, and 52.2% of Sample 1 was female. Sample 2 consisted of 235 clinical psychologists. More than 85% of them had a master or doctoral degree, and 63.9% of this sample was female.

### The Process of the Instrument Development of the C-PAC scale

In Study 1, 46 senior clinical psychologists from health-related institutes or universities were recruited to have a 1.5 to 2-hour in-depth interview. These interview data were coded and analyzed via the techniques of the Grounded theory and the Consensual Qualitative Research to generate items to assess PAC in Taiwan. An initial item pool of the C-PAC scale included 84 items that were grouped into 13 domains to represent core components of psychological assessment competency in Taiwan. In Study 2, 235 clinical psychologists were recruited to respond to the C-PAC scale to examine the psychometric properties of this instrument.

### Data Analysis

Data analyses were carried out using the Statistical Package for the Social Sciences (SPSS for Windows, version 16.0, SPSS Inc., 2007). Reliability and validity were assessed by Cronbach's  $\alpha$  and construct validity. Construct validity was examined by the exploratory factor analysis (EFA) to explore the factor structure of the C-PAC.

## Results

**Study 1.** Sample 1 included 46 senior psychologists from health-related institutes or universities. These psychologists were recruited to have a 1.5~2-hour in-depth interview. All these interview data were coded and analyzed by the techniques of the Grounded theory and the Consensual Qualitative Research. Eighty-four indicators were generated from these interview data. These indicators served as an initial item pool of the C-PAC scale to explore the PAC conceptual framework in Taiwan.

Among these indicators, 48 of them could be included in one of the eight-factor model (i.e., the U.S. PAC model). The other 36 indicators that did not belong to any U.S. PAC factor were grouped into five different domains, such as personal attributes, and clinical inferences. These five domains seemed to represent different aspects of psychological assessment competency, which were related to foundational competencies proposed by Rodolfa, Bent, Eisman, Nelson, Rehm, & Ritchie (2005).

**Study 2.** Sample 2 consisted of 240 clinical psychologists in Taiwan to examine the psychometric properties of the C-PAC scale. The exploratory factor analysis (EFA) on

this psychologist sample indicated a ten-factor model that explained 67.44% of the total variances. All these factors were labeled as the following: (1) Technical Assessment Skills, (2) Professional Relationship, (3) Psychology Background Knowledge, (4) Reciprocal Impacts between clients and psychologists, (5) Psychometric Basic Knowledge, (6) Self-Awareness during Diagnosis and Intervention, (7) Ethic Issues & Intervention, (8) Evidence-Based Practice, (9) Personal Attributes, and (10) Openness of Belief System. Their corresponding Cronbach's alpha values were 0.90, 0.88, 0.85, 0.86, 0.76, 0.65, 0.51, 0.88, 0.86, and 0.83.

## Discussion

As a newly developed instrument, the psychometric properties of the C-PAC scale are good. The EFA results of this study partially supported the theoretical 8-factor model generated from the 2002 competencies conference. Factors not included in the theoretical 8-factor model seem to illustrate other important competency domains for Taiwanese clinical psychologists in their daily practice. Findings of this study provided a culturally relevant framework for assessing psychological assessment competency in Taiwan. More research needs to be done to examine the psychometric properties of the PACS on Taiwanese people at different levels of professional development.

## References

- Epstein, R. M., & Hundert, E. M. (2002). Defining and assessing professional competence. *Journal of the American Medical Association, 287*, 226-235.
- Fouad, N. A., Grus, C. L., Hatcher, R. L., Kaslow, N. J., Hutchings, P. S., Madson, M. B., Collins, F. L., & Crossman, R. E. (2009). Competency Benchmarks: A model for understanding and measuring competence in professional psychology across training level. *Training and Education in Professional Psychology, 3*(4), S5-S26.
- Groth-Marnat, G. (2000). Visions of clinical assessment: Then, now, and a brief history of the future. *Journal of Clinical psychology, 56*, 349-365.
- Hsu, C. T., Huang, C. H., & Cheng, C. C. (2009). Practice survey of clinical psychologists in Taiwan. *Research in Applied Psychology, 41*, 43-55.
- Kaslow, N. J. (2004). Competencies in professional psychology. *American Psychologist, 59*, 774-781.
- Krishnamurthy, R., VandeCreek, L., Kaslow, N. J., Tazeau, Y. N., Miville, N. L., Kerns, R., et al. (2004). Achieving competency in psychological assessment: Directions for education and training. *Journal of Clinical psychology, 60*, 725-739.
- Meyer, G. J., Finn, S. E., Eyde, L. D., Kay, G. G., Kubiszyn, T. W., Moreland, K. L., Eisman, E. J., & Dies, R. R. (1998). *Benefits and costs of psychological assessment in healthcare delivery: Report of the Board of Professional Affairs Psychological Assessment Work Group, Part I*. Washington, DC: American Psychological Association.
- Piotrowski, C., & Zalewski, C. (1993). Training in psychodiagnostic testing in APA-approved PsyD and PhD clinical psychology programs. *Journal of Personality Assessment, 61*, 394-405.
- Watkins, C. E. (1991). What have surveys taught us about the teaching and practice of



psychological assessment? *Journal of Personality Assessment*, 56, 426-437.



*Tragedy Aesthetics of Ki-duk Kim film*

Yu Di Huang\*<sup>1</sup>, Chien-Chih Lin\*<sup>1</sup>, Li-Chieh Chen\*<sup>2</sup>, Mei-Chu Cheng\*<sup>2</sup>,  
M-H. Mia Chen\*<sup>2</sup>

Chung Chou University of Science and Technology, Taiwan\*<sup>1</sup>, Ta Tung University,  
Taiwan\*<sup>2</sup>

0245

The Asian Conference on Psychology & the Behavioral Sciences 2013

Official Conference Proceedings 2013

Abstract

Ki-Duk Kim (1960 ~) is a very well-known film director in Korea that was the best director award at the Venice Film Festival and the Silver Bear award at the Berlin International Film Festival. In 2012, Kim's 18th works (Pieta) won the Golden Lion Award for best film at the 69th Venice Film Festival. Venice Film Festival chairman of vetting committee Mule has described Kim movie: The other award-winning films win in the story, yours win in images. Kim drives erotic body into more beyond normal imagination and creates visual images which are more violent and more brutal. In this study, a literature review and analysis will made to Kim over the years works, such as The Isle, Samaria, 3-Iron, Bad Guy and Pieta. Kim focuses on the violent character of the margins of society presents, love from manifold, sadomasochism, self-flagellation, and even the development of the more bizarre violence aesthetics through the observation of animal abuse. On the other hand, Kim movie performance style like create Oriental cloistered life situations, "Water" is one element of the special representative of significance. Consolidated Kim film work over the years observed, editor believe that Kim's advocates is get rid of the theory, opposing use theory to drive away the love of humanity. Therefore, the image its symbolic expression instead reincarnation conflicts frustration and the shared desire staggered shocks childhood lay tell, this large sense of the different personality and Freud's psychoanalytic theory sources.

Keyword: Ki-duk Kim, Freud, Offensive driving force, Tragedy aesthetics, Margins of society

## I. Introduction

In this era full of intense depression, perhaps for the arts, with the academic theories about aesthetics is a good definition. But the eyes of the viewer is still the most realistic assessment to decided good or bad of the art, when our heart feel weary and fatigue, we will no longer accept even though what we are seeing ° Aesthetic feeling, for all the people who born with it, there is always a theory in operation, and aesthetically pleasing is most authentic for everyone, furthermore, play a very important role in an appreciation of art images. Even more color and visual styles will be create with technology and media, more complex and difficult theory will be found, but only the most full of vitality best masterpiece will always attracted the attention of the audience.

### 1. Ki-Duk Kim

Venice Film Festival chairman of vetting committee Mule has described Kim movie: The other award-winning films win in the story, yours win in images. Kim drives erotic body into more beyond normal imagination and creates visual images which are more violent and more brutal. Ki-Duk Kim is a very well-known film director in Korea; He was also the Best Director of Silver Lion award at the Berlin International Film Festival and the Silver Bear award director at the Venice Film Festival at the same time. Kim Ki-duk's movie works for me is very shocking and impressive, The style of his works contain details of the sensitive and emotional tearing, He likes use the passion and bloodshed to deal with the emotional detail. But the emotional detail makes the audience who watch mixed into an abstract edge emotion emerged. And the main reason why talk about the film director Ki-Duk Kim is the author's own school days by the Taiwan New Cinema, Hou Hsiao-hsien, and Tsai Ming-liang's preferences. Also, the author thinks about the situation of the technological arts development, the same and different points between these traditional art film and computer art animation.

Ki-Duk Kim his creative theme is very broad, including hatred, violence, abnormal love, humble, and also contains the human body, marginal people and nude. His image style relatively leant to ink painting but there is a real world will be presented in the mind, just as he described the scenery, Ki-Duk Kim not just describe it but also put personal feelings and opinions inside. I chose one film 2000 made (The Isle) to talk about Ki-Duk Kim's image symbol. If you ask me why the film attracted me, in fact, the ambience is very simple. This movie make you looked at it very coolness just

like to see the scenery from your room, unknowingly, you will be captivated by this dark gray in it and so harmonious, it's like you're lying beside a lake enjoying the breeze flow and sun roast your back on the boat, with this you even be able to smell the natural atmosphere.

Ki-Duk Kim is one of Korea's very well-known film directors who won the Best Director Award at the Venice Film Festival, the Berlin International Film Festival was "a concern" Silver Bear and the Cannes Film Festival Award, he became the first to include the world's three major International Film Festival honor South Korean director. Ki-duk Kim was born in South Korea on December 20, 1960 Fenghua, studying agricultural technical schools. From the age of 15 in Seoul Guro Industrial Park and along the Cheonggyecheon factory work, spend a teenager. Voluntarily joined the Marine Corps in the age of 20, five years after the Association Theological Seminary Theological Seminary enrolled, but was more interested in painting, so to go to France to study painting became a street artist between 1990 to 1992, and rely sell paintings to make a living, and later the creation video with a clear ink painting heritage. 1992 in France saw two films are "Silence of the lambs The Silence of the Lambs (1991)" and "bridge lovers The Lovers on the Bridge (1991), the initiation of the dream of becoming a director, returned to South Korea after learning writing movie scripts. 1996 film debut "Crocodile Crocodile, launched at an alarming rate work, work style and violence caused a lot of controversy in South Korea. Between 2000 and 2001, Kim Ki-duk gradually Island the Isle "and" addressee unknown Address Unknown "two consecutive years selected for the Venice Film Festival, and thus opened his international reputation. In 2002, his "coastline The Coast Guard became the opening film of the Pusan International Film Festival. A very Zen Buddhism "spring 2003 to spring again Spring Summer Fall Winter and Spring" to a whole new audience shock and surprise. In 2004, with "compensated dating angel Samaria" won the Berlin Film Festival's Silver Bear for best director, and won the Director Award at the Venice Film Festival the same year with another work, "Vacancy Valentine 3-Iron, has become one of the famous directors of the International. In 2008, a sudden seclusion in rural Gangwon-do may be due to long-term cooperation of the students to leave, and shooting "sad dream Sad Dream Lee Chennai Picture hanged himself scenes and nearly died, made him make such a decision. 2011, the first time in three years in autobiographical form documentary film "Arirang Arirang, lighting, sound and editing have personally completed a" movie "," a concern in the 64th Cannes Film Festival Un Certain Regard "?" (and stopped on the tracks," the German director Andreas • Stopped on Track by Andreas Dresen for?) 2012, 18 works of Kim Ki-duk "Holy War Pieta" won the Golden Lion

for best film award at the 69th Venice Film Festival, the highest honor of the world's three major film festivals in Venice, Cannes, Berlin is the first Korean film.

## 1. Research methods and steps

Collect Ki-duk Kim movie reviews and movie news coverage in recent years, as well as Freud psychoanalytic theory and literature analysis. Freud had proposed "personality structure" mode, "spirit of power energy allocation and personality development course. Three forms from the anxiety that are reaction of the "reality", the "neurotic" and the "moral" nervous anxiety and four main sources: (1) physiological growth process (2) frustration (3) conflict (4) the threat of view, this also corresponds to the tragedy personality of the Ki-duk Kim movie "reality principle" and "idealistic principles".

### (II) A same or different point of flowing Light and shadow

Through light, we can see the beauty of the material. Apart from light, things will get ugly do not seem right, the music is a good example. The beauty of music with it a lot of sound and tone changes, concerts cause people's physiological reactions and attitudes, symbolic language and up to resonate through the sound waves to stimulate the transfer of new ideas and soul. Light watercolor liquidity Beautiful, but no shadow will make the United States like many common different point of incomplete, traditional painting and multi-media art from the knowledge judgments, this is our natural physiological analysis. Watercolor transfer the drift and 3D stereoscopic film feel different types of beauty, but we may still feel and enjoy it, along with the mind / brain, light, shadow, silent convey. Through inference and assumptions, the heart processed signal complex, we find a path to touch its core also feels it. Traditional painting like a fake black like the real light, Science, Technology and the Arts, but exponentially fake black seems to focus more loving eyes staring at it.

## 2. Content analysis

In Ki Duk Kin's movie "hungry spirit" and "combat" shooting, with the lowest budget in a short period of time. Violent character of the film focuses on the margins of society presents, from the early "Crocodile Crocodile", "young prostitutes Birdcage Inn, Isle Room The Isle," Gadjoo Bad Guy "to the recent" A door Amen "and" Pieta Pieta "Kim's name is always abnormal love, sadomasochism, masochistic vendetta, loneliness, despair, humble and shame dark words linked to, or even observe the development of the more bizarre aesthetics of violence through animal abuse. To his

adjectives violence, bold, cruel, bloody, alternative edge, Erotic, amazing. In 2012, Kim Ki-duk's *Pieta* won best film at the 69th Venice Film Festival Golden Lion Award. Venice Film Festival jury member Xi Mule Kim has described the film: "The other award-winning films win in the story, your movie to win on the image". The erotic body into a more-than-normal imagination to create a more violent and more brutal visual images. On the other hand, Kim's performance style of the film, like create the Oriental seclusion life situations, "water" element has its special representative significance. 6 Kim Ki-duk Film Synopsis in this, so read further knowledge and understanding of Kim Ki-duk film style.

In *(The Isle)* Ki-duk Kim portrayed a female nude lying on the ship. This is a whole body frame of portrait. The woman's face appears to be pure and innocent because it is naked, you can directly see her plump breasts, but you only feel a tenderness and quiet feeling. Time seems to be stopped. The basic color of this frame is blue, yellow and black, with a deep black Ki-duk Kim cut the image from middle, you can directly aware of the contrast between the woman and the hull, which makes the body parts more stereoscopic. Ki-duk Kim use his most good at ink film style and technique make detail very vivid, but still concealed his mental state and attitude toward life.

#### 1. The chamber plot of the *Crocodile*:

Live below a bridge over the Han River, the three poverty Rangers: Grandpa, the little boy, and a young and impetuous, cynical young crocodile. The crocodile accustomed to jumping into a river to commit suicide the bodies of those hidden, to extort money from the family of the deceased. One day, he rescued a bad gang rape the girl committed suicide, but he also sexually abusing her. The girls will also live in the bridge, with the passage of time, the crocodile cold heart melt gradually; a family of four lived a poor but peaceful life. However, when the "crocodile" to leave her, the girl again jumped into the river, "crocodile" for her to sneak into the river.

Comment: Everyone personality? Both more or less dark sides, just like a real crocodile, the film is about human transformation, and the two sides of people. Indifference crocodile demonstrated by the people around him, but only the subconscious self-protection, in truth wrapped his deepest vulnerabilities; if you do not want to be hurt, helpless perhaps stop hurting those who care about us



## 2. The chamber plot of the Isle:

A quiet and lakes in the mountain in a cottages travelers to come here fishing, accommodation, operating proprietress of these houses are beautiful, but silent, sell some snacks and fishing tackle, always during the day and night selling their body, to soothe lonely emptiness of these anglers. The occasional humiliation imposed on guests and wife will take advantage of the dark let the man assassination and then thrown into the lake, no one knows it, Lake, always, as usual silence ...

One day, a sight cheating on his girlfriend kills the police came here to look for short, The proprietress was intense discourage from the two maintain a ray of affection and burst-like relationship, the joy of sex he could not die relief, and thus, hovering between life and death...

Comment: Silent proprietress police drama male and female, between the two beautiful love affair with fetters, was established on the basis of cruel and unbearable, greeting each other with the extreme hooks self-mutilation self-flagellation method to get beyond the pain relief, metaphor hooked to each other, can no longer be separated. And brutal picture of the animal and far beyond the normal visual experience and imagination, disposable violent animal life, we will face to the unknown.

(The Isle) 2000 Feature Film Material: film 135 minutes Director: Ki-Duk Kim & Team

In (The Isle) Ki-Duk Kim portrayed a female nude lying on the ship. This is a whole body frame of portrait. The woman's face appears to be pure and innocent because it is naked, you can directly see her plump breasts, but you only feel a tenderness and quiet feeling. Time seems to be stopped. The basic color of this frame is blue, yellow and black, with a deep black Ki-Dut Kim cut the image from middle, you can directly aware of the contrast between the woman and the hull, which makes the body parts more stereoscopic. Ki-Duk Kim use his most good at ink film style and technique make detail very vivid, but still concealed his mental state and attitude toward life.

## 3. The chamber plot of the Spring Summer Fall Winter and Spring:

In this film, he created a blurred visions of an ink-like Buddhist monks practice the precepts of life as the main story branches loudly from childhood, juvenile desire of the workers of iniquity middle-aged and elderly Lost different stages of life, with the spring and summer autumn and winter operation the Evolution of the development of the plot, Four Seasons inertia reincarnation illustrates the vagaries of life.

Comment: Kim works to violence and sexual important feature, one of the Spring Summer Fall Winter and Spring, Ki-Duk Kim, a change in the style of the past. Whole movie viewfinder in an old temple is located in the lakes, four distinct seasons, beautiful scenery, watching a movie like enjoy depicting beautiful painting, Zen is very strong. There is not much dialogue, but by a few simple picture sketched out very thought-provoking concept, the young monk stone tied to the body of the fish, frogs, snakes, old monk Master from ignorance of fun to require the body Department of a stone to experience the life of empathy, seemingly simple metaphor, but full of impact.

#### 4. The chamber plot of the Samaria Girls:

Two small tour of Europe, did not hesitate to buy tickets to prostitution to earn money. Such as when drivers lookout in tolerance to pick up. During which pick up the girl fell in love with one of the clients, but one day, in an anti-vice operation in emergency situations and falling off serious injuries, dying request, such as true to her ideal clients to the hospital to see her one last time. True to their clients work to request him the clients requirements really should talk to him to go to bed, go to the hospital. But they arrived at the hospital, has died in capacity. After the death of the content, such as really decided to get back with capacity relationship clients, to provide sexual services, then the money back to them before. Such as the true father when the police found her daughter into prostitution work secret father Clients are to ferret out one by one, and poisoned them.

Analysis: The film immediate reaction to new types of problems and development of the social reality, a kind of "reality principle" and the principle of "ideal" personality tragedy. "Compensated dating" substance was from the beginning, to the redemptive purposes in inner balance between morality and guilt. Front of the movie depicts two girls have fuzzy boundaries of friendship and love, and finally the father and daughter emotion-based although mutual interest, they are nothing but mouth not say to each other's minds are keeping everything, father and daughter in a dream see each other's pain and collapse, but did not comfort each other in the eyes of the reality of the screen, the last car bogged down car before the end of the control card in the pile of stones of the story, and also a symbol of the people will be out of the morass of the day.

#### 5. Plot of the 3-Iron:

The Thailand show is an often Yechuang vacancy unemployed youth, the mysterious identity, whereabouts treacherous day, riding a handsome locomotive walk in the exclusive residential area of the city. As long as the owner of the house is not Yasuhide will use smart unlock skills to enter, but he does so not in order to break-in when the thief, but only want to live in the empty house, empty house is his home. One day, broke into a good home under house arrest by husband of domestic violence, accidental see her play delicate and charming, and Yasuhide hearts gush "hero to save the United States the idea. So he whipped with a golf club that her husband, and then ran away from home with a good Chinese, launched a wonderful journey of love among one after the vacancy.

Comment: one is trying to convey loneliness and alienation in the world, but through a man into one another empty house living, distributing the warmth of the story. "Home" complex film is one of the characteristics of the Orient, the luxury house for good-not "home"; sneak into that empty house restaurants, watching Thai cooking show, processing debris, repair broken furniture, she only "home" feeling. Home people do not cherish the family, no home instead incomparable treasure.

#### 4. Plot of the Pieta:

Mound Road is a ruthless man neither family without a partner. His day job is to use the threat of violence to each other door-to-door to collect debts. Suddenly one day, a middle-aged woman came to the front of him said that he is his mother, and he is her lost son for a long time. Dubious, the two began a period beyond the ethical and moral taboos "mother-child relationship.

Analysis: The film's Italian name "Pieta" means "Our Lady of sorrow the death of Jesus," creative director inspired by Michelangelo's famous sculpture of Our Lady of grief child like this is a certain victim's mother in "Family to tie him down" and "body" as a weapon to avenge his human great tragedy. The climax of the end of the movie, "mother" standing on the abandoned high-rise pretending to be kidnappers threatened her jumping, and went to pieces Mound Road knees for mercy request on behalf of his mother death scene to prove that the "mother" revenge all in the hands, but she finally decided to take the jump, is determined to make the lives of her two "sons" intersection point, in her eyes, but blood is the eternal salvation.

#### IV. Conclusion:

Kim consolidated the film works over the years observed, he can make good use of the unique approach to the interpretation of the destructive but beautiful life and emotions, especially the marginal role tragic life of love and hate. Violence and sexual spindle, he cold-blooded and redemption SynTao to human the play, the aesthetics of violence to express its social criticism. Therefore his work features:

1. Fond of extreme sexual violence, reflecting the profound humanity and national tragedy.
2. Most of the face of the political and social realities of aesthetic form of metaphorical violence.
3. With sex and violence, there female have a pivotal position in those movies, they guide the key to the story and contradictions of human nature.
4. All over the film with various implied symbols, such as water, fog, fish, island and girls.
5. His works often have strong "true reality", "neurotic" and "moral" sense of anxiety in the form.

Ki-Duk Kim (The Isle) is thinking turned quest to get rid of the deep brain signals, Freud's aggressive driving force growth from sex and childhood experience. Insisted that use Freud's theory to dissociation the Ki-Duk Kim image creations will results in frustrated, the beauty of the art of decision based on no equations, it is the original biochemical fusion of elements. The author think Ki-Duk Kim film advocates get rid of theory, opposing theory to drive away humanity's love, therefore, Image its symbolic expression instead reincarnation conflict frustration and enjoy desire for staggered shocks without childhood tell. This is large different sense of Freud's personality psychoanalytic theory sources. In this moment the author think the combination explore of Freud's attack driving force and "elements company with black film aesthetics " is quite a new concept, this is most directly reveal of Humanistic and also the essence of aesthetics. As stated in the light and shadow flow singular points illustrated, instinct and thinking, instincts, thinking and experience melt to give birth the emotional disclosure is the best to see through the most direct sway.

## References:

### English Book:

Ellenberger, H. F. (1970), *the discovery of the unconscious: The history and evolution of dynamic psychiatry*. New York, 1970

Krull, M., *Freud and his father*. New York, 1986

Josef Albers, *Interaction of Color*. Yale University, 1963

Sulloway, F. J., *Freud, biologist of the mind: Beyond the psychoanalytic legend*. New York, 1979

Roazen, P., *Freud and his followers*. New York, 1975

### Chinese Book:

Ching-Tien Yang, etc., 2010, *Design Research Methods*, Chuan Hwa Book CO., LTD.

Zheng Yuan Jin, 2005, *Taiwan Design Innovation helmsman*, Department of Commerce industrial, Ministry of Economic Affairs, Taiwan

Schultz forward, Cheng-Wen Chen, M., 1997, *personality theory*, Prentice Hall

Sun Li, 2005, *audio-visual language of film and television animation*, Heyzer Press

Cao Zhicheng, 2008, *the first session of the image text thinking Symposium*, Chung Chou Institute of science and technology, Department of motion pictures and video Communication

Cao Zhicheng, 2010, *the second session of the image text thinking Symposium*, Chung Chou Institute of science and technology, Department of motion pictures and video Communication

Liu Hongtao, 2007, *by Lawrence modernist cultural politics*, Xiu Wei information

Jun Peng, 2010, *the evening is not too late: after the 1997 Hong Kong film*, Chinese University of Hong Kong

### Periodical:

Glen O. Gabbard, M.D. "The American **Journal** of Psychiatry, VOL. 161, No. 2. 1." February 01, 2004. Sigmund **Freud**, 1856–1939.

Cape and Smith. "Civilization and its Discontents 1930 London: Hogarth Press and Institute of Psycho-Analysis." New York: Pp. 144.

Feliciano, K., "Andrew Wyeth. "American artist, April 1996, Vol.60, p.8

Grant, D., "How the criticized deal with criticism." American artist, June 1995, Vol.59, pp. 66-8+

Moss, E. L., "Andrew Wyeth's landscape. "American artist, June 1998, Vol.62, p.8

Wyeth, A., "Andrew Wyeth..." International Review of African American Art, 2001,

Vol.17, no4, pp.58-9

Website:

Star wooden images company -Silence Code (Woodman Animation Studio)

<http://hero9999.myweb.hinet.net/>; <http://online.tfam.museum/pixar/>

Industrial Development Bureau of the Ministry of Economic Affairs website

<http://www.moeaidb.gov.tw/>

Fancy Frontier magazine <http://www.f-2.com.tw/>

Liang Liang Film Blog

<http://blog.chinatimes.com/c4liang/archive/2012/03/26/97162.html>

King net movie channel

<http://movie.kingnet.com.tw/search/index.html?act=actor&r=1115209122>

The logo for the International Association for Film and Animation Research (iafor) is centered on the page. It consists of the lowercase letters "iafor" in a light blue, sans-serif font. The text is enclosed within a large, light blue circular arc that is partially obscured by a larger, fainter circular arc in the background. A red brushstroke-like arc is also visible, overlapping the blue arcs.



*Stress Resistance, Adaptability, and Emotional Stability of Medical Students  
Obtaining Categories 4 and 5 on the Psychometric Test and Related Factors*

Sri Linuwih Menaldi\*<sup>1</sup>, Adhityawarman Menaldi\*<sup>1</sup>, Iwan Dwiprahasto\*<sup>2</sup>, Aria  
Kekalih\*<sup>1</sup>, Ova Emilia\*<sup>2</sup>, Yayi Suryo Prabandari\*<sup>2</sup>

\*<sup>1</sup>University of Indonesia, Indonesia, \*<sup>2</sup>Gadjah Mada Universitas, Indonesia

0246

The Asian Conference on Psychology & the Behavioral Sciences 2013

Official Conference Proceedings 2013

Abstract

**Background:** In its effort to produce high quality graduates, the Faculty of Medicine University of Indonesia administered psychological tests to assess first year medical students' logical thinking skills and personality. The results of those tests are divided into 5 categories of recommendation, 1 to 5, based on the capability of the students to complete their studies. Fifty six point forty five percent of the students receiving recommendation categories 4 and 5, were considered as at-risk students who were predicted to have difficulties in completing their education. In addition, there were many non-academic factors that affect the learning process to achieve the clinical competence required by the Competence Standard for Indonesian Doctors.

**Research Objectives:** to study the psychological profile of students in the at-risk category and related factors, in which could affect the learning process.

**Results:** Using multivariable analysis, it was found that gender has a significant correlation to stress resistance and adaptability; motivation is significantly correlated to stress resistance and perseverance; whereas birth position has a significant correlation to stress resistance.

**Conclusion:** the psychological profile of medical students including their work attitude and personality as well as other related factors can be used as predictors of success in completing their education. Thus, support and guidance for students should be made available as early as possible in their medical education, particularly for those students in the at-risk category, to help them achieve clinical competence.

**Key words:** medical students, at-risk groups, psychological profile, clinical competence, stress resistance, adaptability, emotional stability

## INTRODUCTION

In 2008 the Faculty of Medicine University of Indonesia administered psychological tests to obtain basic data on student reasoning capabilities and personality. These tests are administered in the first year of their studies. It is hoped that education managers will be able to use this data to design teaching methods in the framework of enhancing the quality of graduates, in accordance with the standard competence of Indonesian doctors (curriculum of the Faculty of Medicine University of Indonesia, 2005). Based on the tests, five recommendation categories were determined, namely 1) undoubtedly recommended; 2) recommended; 3) recommended with considerations; 4) doubtful; 5) not recommended. Students in recommendation categories 1 to 3 are categorized as no-risk students, whereas categories 4 and 5 are at-risk students (Menaldi, dkk., 2009, Santrock, 2009) which are predicted to face difficulties in completing their education.

Based on those psychological tests, it was found that 30 out of 186 students (16,13%) were in category 4, whereas 75 out of 186 students (40.32%) were in category 5. This means that the number of at-risk students was relatively big. However, in principle those students should get the same opportunities to achieve optimal academic performance (Syah, 2009). Thus, the at-risk groups of students should be given academic support services to be able to finish their studies.

Data derived from the counseling team for Medical Students, University of Indonesia (2009), showed that at-risk students face both academic as well as non-academic problems. Non-academic problems that occur are usually personal problems related to the family, finance, culture shock, unfulfilled interests, behavior, personality, and health. Such non-academic problems form part of the background which causes students to fail to achieve academic competence. In the light of this, a research into the at-risk groups was carried out to observe the psychological profile of these students as well as other related factors which are estimated to affect the learning process students go through to achieve competence at clinical level.

## METHODS

This research employed a mixed method of quantitative and qualitative research methods. Respondents are 95 sixth semester medical students attending the regular class at the Faculty of Medicine, University of Indonesia, whose results in the psychometric test placed them in categories 4 and 5. In the initial stage, the respondents were given psychological tests and were requested to complete their personal information in the Life Environment sheet to in order to obtain a description of their: 1) Intelligence and general capability; 2) Working attitude including speed, accuracy, stress resistance and perseverance; 3) Personality which covers emotional stability and adaptability; and 4) Interests and motivation to excel. After that in-depth interview were conducted to 23 (24.2%) of the respondents which was carried out in March 2011.

The testing instrument used was the CFIT (Culture Fair Intelligence Test), Basic Capability Test, Kraepelin and SDS (Self-Directed Search) Holland and graphic tests. Those testing instruments have been standardized and produced by the Institute for the Development of Testing Instruments and Psychological Education (LPSP3)

Faculty of Psychology University of Indonesia. CFIT was used to assess intelligence using the following scales: 1) below average (80-89); 2) average (90-109); 3) above average ( $\geq 130$ ). Other assessments were done using the five psychogram classification with a scale of 1-20, namely: 1) very poor or low (1-4); 2) poor (5-8); 3) sufficient (9-11); 4) good (12-15) and 5) very good or high (16-20).

The psychological test results were analyzed using a quantitative method to prove relations between variables. Dependent variables were speed, accuracy, stress resistance, perseverance, emotional stability and adaptability. Whereas the independent variables comprised gender, intelligence, interests, talents, motivation, learning behavior, life environment including age, birth position in family, place of residence and High school of origin. Statistical analysis was done in stages. First bi-variables followed by multivariable analysis using multiple linear regression analysis. All the statistical analysis was done using computer statistics software SPSS ver.11.5. In the following stage, the respondents went through an in-depth interview which was analyzed qualitatively to reinforce the quantitative tests (Creswell, 2003; Poerwandari, 2009).

## RESULTS

### Quantitative Analysis

The psychological tests produced psychological profiles of the respondents relating to talent, interests, motivation, working attitude and personality can be seen on table 1 and 2. Table 1 depicts the psychological profile of students in terms of talent, interest, motivation to excel and the learning behavior. Assessment of talent cannot be done only through one test. Higher percentages of female students (41.5% compared to 30%) were found at superior IQ levels. The SDS Holland test was used to assess vocational and educational interests based on individual personality, social, artistic, investigative, realistic, enterprising and conventional interests. Investigative interest ranks as the first interest for both male and female respondents, which the proportion of males is quite big (70%) and much bigger compared to that of female students (46.2%). Most of the respondents (82.26%) have sufficient motivation to achieve, whereas the rest (14.74%) lack this type of motivation. Through learning behavior, learning strategies/approaches, regularity, sufficient time allocated and time used to study, can be observed. Most of the respondents used a superficial learning approach (44.21%).

**Table 1. Psychological profile of at risk respondents in terms of talent, interest, motivation to achieve/excel and learning behavior (N=95)**

Aspects	Male		Female		Total	
	n	(%)	n	(%)	n	(%)
<b>1. Talent</b>						
<b>a. Intelligence based on IQ (CFIT)</b>						
Mean (90-109)	3	10,0%	6	9,2%	9	9,47%
Above average (110-119)	8	26,7%	11	16,9%	19	20%
Superior (120-129)	10	33,3%	21	32,3%	31	32,63%

Very superior (130->145)	9	30,0%	27	41,5%	36	37,9%
<b>b. General capability based on Kraepelin</b>						
Sufficient (9 – 11)	3	10,0%	6	9,2%	9	9,47%
Good (12 – 15)	18	60,0%	32	49,2%	50	52,63%
Very Good (16 – 20)	9	30,0%	27	41,6%	36	37,90%
<b>2. Interest based on SDS Holland test</b>						
<i>Social (S)</i>	5	16,6%	19	29,3%	24	25,26%
<i>Artistic (A)</i>	1	3,3%	11	16,9%	12	12,63%
<i>Investigative (I)</i>	21	70,0%	30	46,2%	51	53,68%
<i>Realistic (R)</i>	0	0%	0	0%	0	0%
<i>Enterprising (E)</i>	3	10,0%	4	6,2%	7	7,37%
<i>Conventional (C)</i>	0	0%	1	3,3%	1	1,05%
<b>3. Motivation to Excel based on graphic tests</b>						
Poor (5 – 8)	4	13,3%	10	15,4%	14	14,74%
Sufficient (9 – 11)	26	86,7%	55	84,6%	81	85,26%
<b>4. Learning Behaviour based on life environment sheet</b>						
<i>Superficial</i>	10	33,3%	32	49,2%	42	44,21%
<i>Deep</i>	16	53,3%	19	29,2%	35	36,84%
<i>Achievement</i>	4	13,3%	14	21,5%	18	18,95%

Table 2 depicts the psychological profile of students in terms of work attitude and personality. Work attitude comprised work pace, meticulousness, stress resistance, and perseverance, whereas personality comprised emotional stability and adaptability. An analysis of work pace shows that 50.53% of the respondents are classified as 'good' which is the biggest psychogram classification; however, it was found that 8.42% of the respondents were in the 'poor' range. A greater part of the respondents (77.89%) were classified as sufficient, none were in the very good category (77.89%) in meticulousness. The percentage of females classified as very poor (1.54%) was lower than that of male respondents (3.33%). A greater number of the respondents have quite good stress resistance (83%) and the rest poor (16.84%), with all male respondents have sufficient stress resistance. In term emotional stability, it showed that both female and male respondents were classified as poor (41.05%) to sufficient (58.95%) in this aspect. The proportion of males with poor emotional stability was relatively smaller than females. In adaptability of personality, it was found that 57.90% of the respondents were in the sufficient classification and 42.10% in the poor classification. Fewer male respondents (40%) classified as sufficient compared to females (66.15%).

**Table 2. Psychological Profile of work attitude and personality of the at-risk group (N = 95)**

Aspect	Male		Female		Total	
	n	(%)	n	(%)	n	(%)
<b>Work attitude</b>						
<b>Work pace</b>						
Poor	3	3,16%	5	5,26%	8	8,42%
Sufficient	8	8,42%	21	22,10%	29	30,52%
Good	12	12,63%	36	37,90%	48	50,53%
Very good	7	7,37%	3	3,16%	10	10,53%
<b>Meticulousness</b>						
Poor	1	1,05%	1	1,05%	2	2,11%
Sufficient	2	2,11%	6	6,32%	8	8,42%
Good	25	26,31%	49	51,58%	74	77,89%
Very Good	2	2,11%	9	9,47%	11	11,58%
<b>Stress Resistance</b>						
Poor	0	0%	16	16,84%	16	16,84%
Sufficient	30	31,58%	49	51,58%	79	83,16%
<b>Perseverance</b>						
Poor	10	10,53%	15	15,79%	25	26,31%
Sufficient	20	21,05%	50	52,63%	70	73,69%
<b>Personality</b>						
<b>Emotional Stability</b>						
Poor	13	13,68%	26	27,37%	39	41,05%
Sufficient	17	17,90%	39	41,05%	56	58,95%
<b>Adaptability</b>						
Poor	18	18,95%	22	23,16%	40	42,10%
Sufficient	12	12,61%	43	45,26%	55	57,90%

Based on Table 3, it can be concluded that gender has a significant effect on stress resistance as a work attitude ( $p = 0.003$ ), as well as adaptability which is a personality trait ( $p = 0.016$ ). Motivation to excel has a significant effect on stress resistance ( $p = 0.041$ ) and perseverance ( $p = 0.001$ ). Position of birth in the family ( $p = 0.030$ ) has a significant effect on stress resistance ( $p = 0.030$ ), and tends to be correlated to emotional stability and adaptability ( $p = 0.116$ ). IQ ( $p = 0.062$ ), interest ( $p = 0.157$ ) and talent ( $p = 0.143$ ) tend to correlate to meticulousness as a working attitude. The respondent's age tends to correlate to working pace ( $p = 0.146$ ). High school of origin also affects stress resistance ( $p = 0.183$ ).

**Table 3. Factors affecting the work attitude and personality of the at-risk group of students. (N = 95)**

Variable	Work Attitude				Personality	
	Pace	Meticulousness	Stress Resistance	Perseverance	Emotional Stability	Adaptability
Gender	0,757	0,910	<b>0,003*</b>	0,291	0,759	<b>0,016*</b>



IQ	0,623	0,062	0,293	0,228	0,859	0,623
Talent	0,424	0,143	0,673	0,553	0,965	0,461
Interest	0,653	0,157	0,577	0,798	0,670	0,744
Motivation	0,389	0,655	<b>0,041*</b>	<b>0,001*</b>	0,882	0,069
Learning behavior	0,788	0,594	0,765	0,587	0,683	0,777
Age	0,146	0,651	0,766	0,286	0,782	0,235
Birth position	0,580	0,602	<b>0,030*</b>	0,636	0,116	0,116
Place of Residence	0,249	0,800	0,457	0,741	0,539	0,320
Original School.	0,668	0,432	0,183	0,872	0,266	0,471

\*  $p < 0,05$

### Qualitative analysis of research results

In-depth interviews were held with 23 (24.2%) respondents and were carried out by three independent psychologists. The results were written up in the form of an interview report and the themes obtained from the psychological interview reports are as follows.

**Interests.** Data obtained from the life environment sheets and the results of the interview could strengthen the results of the psychological tests. All the respondents clearly understood that a doctor's profession is a helping profession, as found in the following excerpts from the interviews

".....another thing that attracted him is the fact that in this field it is possible to help many people..." WPsi2/K/ar/e/26;22-24).

".....her desire to help other people made him choose medical science." "(WPsi2/H/ar/k/20;1-2).

".....her ambition is to establish a hospital for marginal people...." (WPsi2/K/ar/e/33;2-4).

".....ever since she was in high school he was interested in health matters. Becoming a member of the Red Cross Youth developed this interest further. (WPsi2/D/ar/e/31;2-5).

The quotations above show that the great interest to become a medical doctor developed in early in the respondents' life. This interest grew stronger with their daily life experiences. This interest in medicine helps the students to finish their studies successfully as they are fully aware of their responsibilities during their medical education.

**Motivation.** Data on respondents' motivation to take up medicine at the faculty of medicine was obtained through the life environment sheets. 63.16% of the respondents, both males and females, have very good internal motivation to support their studies. In general, respondents with good internal motivation also have external motivation which supports their efforts to complete their studies. 29.47% of the respondents seemed be without any motivation, both internal and external motivation.



7.37% only had external motivation. Positive internal motivation themes found in the interviews are as follows:

”...The reason for choosing the faculty of medicine was to improve the status of the family, because she believes that becoming a doctor is the highest profession. (WPsi2/ E/ar/e/04;5-8).

“...My role model was my pediatrician when I was still in Bandung. The doctor was very pleasant and it was nice to talk to me, he made me feel comfortable not like the other doctors he had experienced. Those doctors were so different from the pediatrician. ..” (WPsi2/K/ar/k/05;7-11).

Interviews with the respondents showed a lack of internal motivation but a strong external motivation as shown by the following excerpts:

”...at first I was thinking of taking chemical engineering rather than medical science. ... However, during entrance examination preparation classes my teacher told me that the medical faculty would be a good choice for me. (WPsi2/ E/ar/e/06;1-6).

”...Actually becoming a doctor was not my ambition when I was a child... my father planted this ambition in me... he told me the reasons, he gave me input and he urged me strongly to become a doctor. ...(WPsi2/H/ar/k/62;1-5).

Students with little internal motivation could perhaps complete their studies successfully if they get strong support from the environment. However, there were also students with sufficient internal motivation reinforced by external motivation, as seen in the following excerpts from the interviews:

”....his motivation to study medicine is that he believes that a medical doctor is very esteemed profession and he/she would like to have a doctor in his/her family...” (WPsi2/G/ar/e/17;6-8).

”....her parents really wanted one of their children to become a doctor; nevertheless, none of her elder brothers or sisters want to be a doctor. This is why she chose to study to become a doctor and this desire was supported by her family.....” (WPsi2/D/ar/e/31;6-10).

**Learning Behavior.** The learning behavior of the respondents can be seen from the way they learn and the learning approach that they have chosen. Male and female respondents have their own approach to learning which varies a great deal, as reflected in the excerpts from the reports on the interviews:

”...when he goes home in the evening, he goes to bed at 9 or 10 and then wake up at 3 o'clock in the morning to study. The learning strategy that he uses to study is by taking down notes while reading...” (WPsi2/I/ar/k/35;15-18).

”...Although he does not have a daily and regular routine for studying, he/she usually sets aside time to study intensively when examination time approaches....” (WPsi2/I/ar/e/19;32-35).

”...She realizes that it is easier for him/her to understand material by listening to people explain the material...” (WPsi2/D/ar/e/31;22-24).

"...He also often explains material to friends when they are studying together as he/she thinks that by doing this he/she can understand the material much easier..." (WPsi2/K/ar/k/05;25-28).

"...Learning by doing short screening, 1 or 2 days before the examinations he will study with friends. (WPsi2/K/ar/k/13;25-27).

**Life environment.** Based on personal and family data obtained from the life environment sheet, a majority of the respondents are first born. Based on that fact, it is expected that the respondents are more independent and have a bigger sense of responsibility which will enable them finish their studies. Nevertheless, independence and responsibility are also affected by environment. The following are excerpts from the interview reports conducted which show the effect of birth position on their studies:

"...she did not desire to become a medical doctor; however, because of pressure from his/her family he/she finally decided to become a doctor..." (WPsi2/H/ar/e/34;20-22).

"...In his family MFA is the first born of three siblings. At present his family is living in Germany... He always wanted to become a doctor." (WPsi2/K/ar/e/26;1-4).

The excerpt above shows that the responsibility that the first born shows towards his/her family and his/her decision to study to become a doctor, often overcomes his/her own ambitions. Nevertheless, quite a few of them chose to study medicine because of their own ambition to become a doctor, as well as patterns and habits that have been formed in the family, as seen from the following excerpts:

"...AF is the third child of five siblings. He always wanted to study medicine..." (WPsi/I/ar/e/19;1-3).

"...she is the youngest daughter in her family. Her father is a doctor. She has been exposed to the medical profession ever since she was a child and thus she became interested in becoming a medical doctor..." (WPsi2/H/ar/k/21;1-4).

Based on data about place of residence it was found that those respondents who did not live with their parents generally lived around the campus in boarding houses or rented rooms. Most of the respondents coming from Jakarta and the surrounding areas live in rented rooms during the week and go home to their parents on weekends or holidays. Female respondents generally live with their parents even though many of them complain about the distance they have to travel to get to campus as well as the transportation and the traffic jams in Jakarta. On the other hand, living in rented rooms, students still had other problems to cope with, among others the lack of internet connection. Although in terms of residence, student boarding houses are still very popular because they are cheap, breakfast is provided and internet connections are available. The short distance between their rooms and the campus can reduce physical fatigue and can save their time and energy. Thus the place of residence of the respondents does not pose problems in their education.

Excerpts from the interview reports show the various problems that occurred are related to family and living environment as well as social environment. These can affect the study pattern of the students in either a negative or positive way.

"...When her parents who lived in another city came to visit him/her, it was difficult for him/her to manage his/her time..." (WPsi2/D/ar/k/07;19-21).

"...Although he lives far from the family, he is still aware of the great support that he/she received from the family ..." (WPsi2/K/ar/e/26;38-40).

"...After the death of her mother, she felt a lot of pressure and family problems often disturbed his/her focus and concentration on learning..." (WPsi2/D/ar/e/31;45-48).

"...he had problems in socializing especially adapting himself to the environment due to the difference in cultural backgrounds which resulted in students forming groups..." (WPsi2/I/ar/e/19;18-21).

"...My parents are always there when I am down and they are always ready to listen. They also always give their support by listening and giving motivation..." (WPsi2/G/ar/e/35;45-48).

"...Usually the support of friends, who have been struggling together ever since they entered the Faculty of Medicine. is very helpful to revive their spirit to learn..." (WPsi2/K/ar/k/32;48-51).

Based on the excerpts above, it can be concluded that non-academic factors affect the learning process in both s positive and negative way.

## Discussion

The mixed method, which used in this research, will integrate, link and analyze quantitative and qualitative data (Creswell, 2003). The quantitative approach makes use of certain standards that are not applicable to research into behavior (Poerwandari, 2009). Thus, the advantage of using this approach is that the qualitative approach can be used to reveal phenomena that occur, and can provide clarification and reinforce the findings of the quantitative research.

Gender has a significant statistical effect on stress resistance and adaptability. In this research it was found that males have better stress resistance than females; however, females did better in terms of adaptability. In various research related to gender, it was found that there is no difference between the cognitive abilities of males and females (Papalia, dkk., 2001; Santrock, 2003; Schunk, Pintrich, Meece, 2010). In the field of medicine, the biggest contribution related to gender is in doctor-patient communication. Women tend to orient themselves to their patients and thus establishing a good rapport with their patients is a priority. They do this by showing more empathy and asking more questions compared to men (Dielissen, et al., 2011). However, during their education, women tend to be more emotional and experience more somatic problems compared to men (Barbaria, et al., 2011; Niemi & Vainiomaki, 2006). The choice of interest, career and work is also influenced by gender (Crolla & Bamforth, 2011). Stress resistance, adaptability and morality are important factors during medical education especially when related to gender. This condition needs to be given special attention as there tends to be more female students than men at the faculty of medicine.

In this research it was found that motivation to excel has a significant statistical relationship with stress resistance and perseverance. In addition, internal motivation to

become a doctor who is quite significant for all respondents (65.16%), and is expected to provide the respondents with a good drive to reach their ambitions. Those respondents with little internal motivation should be given guidance (external motivation) to develop and strengthen their internal motivation. This is in line with the opinion of an educational psychologist (Adele Gottfried, 1990; in Santrock, 2003) who believes that strong internal motivation and low levels of anxiety are linked to the achievement that they want to attain. As for motivation in the learning process, research by Octaviana (2011) found that the total motivation is significantly higher in first-year students and students who are less than 20 years of age compared to fourth year students. Research by Samira (2011) also found that the strength of motivation as compared to students' learning approach will decrease with the period spent studying at university. With reference to the research by Octaviana (2011) and Samira (2011), the significant relation between the motivation to excel and stress resistance and perseverance showed that the motivation to become a medical doctor is a positive predictor of successful achievement of clinical competence. The academic supervisor plays a very important role in providing support for students lacking motivation or without stable motivation. This support should be provided to those students as early as possible in their medical education.

In this research, age, birth position in the family and place of residence are part of the living environment. Statistically, birth position in the family has a significant relationship with stress resistance and tends to be linked to emotional stability and adaptability. These results confirm Santrock's findings (2003) that the first born children in a family are more grown up, more helpful and more able to control themselves. When we take note of the findings of the interview report on life environment it can be seen that birth position in the family affects the students' sense of responsibility to finish their education. Parents often demand high standards of their first born children and expect them to achieve success in their studies as well as their careers. Parents also expect their first born children to have greater responsibility towards themselves and their families. Thus these children will train themselves to meet these demands and to cope with all the pressure, control their emotions and present themselves as more mature persons.

When linked to the respondent's interests and gender, the combination of investigation and social interests found in female respondents are essential for the profession of a doctor. Thus, a great interest in the field which induces one to choose to take up a medical education as stated in the psychological interviews report, should be able to enhance that person's precision and determination to complete his/her education. The talents that people have show their potentials (Anastasi, 1998, quoted by Semiawan, 2009) and this is necessary as a basis of their interests which influences the magnitude of the results achieved. Based on the analysis, intelligence and talents can become factors which influence the achievement of expected competencies.

The data in this research shows that the high school students have graduated from tends to be linked to their stress resistance as one of the aspects of work attitude. Students coming from high schools in Jakarta tend to have more resistance when put under pressure during their studies. This is because the environment of their present life is not too different from their environment during high school, or perhaps they were already aware of the characteristics of and the learning atmosphere at university. On the other hand, students from outside Jakarta need more time to adapt themselves

to the new environment and culture of the university which is different from what they were used to at school. The psychological interviews pertaining to that matter reinforce the quantitative results of this research. In addition, students from outside Jakarta often face financial problems which could affect their studies.

Nevertheless, when linked to the psychological interview report, it is clear that students have a wide variety of learning behaviors and an approach to learning that they adapt to the situation they find themselves in. This is supported by the findings of Octaviana's (2011) research which shows that students coming from high schools outside Jakarta have a stronger motivation and a greater variety of learning strategies compared to students from high schools in Jakarta.

Finally, Norman Garmezy's research (Garmezy & Masten 1985, 1993; quoted in Santrock, 2003) identifies three factors which could assist children and adolescents in developing resistance towards stress, namely: 1) cognitive skills and a positive response to others, 2) a friendly, warm, and intimate atmosphere, 3) a certain person or figure who can provide external support. Thus, it is very important for the education managers and academic supervisors to provide assistance to the at-risk group of students to enable them to complete their education.

## **CONCLUSION**

In this research it was found that gender, motivation, birth position in the family and origin of high school of respondents have a significant relationship with stress resistance. It was also found that gender, i.e., female gender is closely related to adaptability. Apart from that birth position in the family has a significant relation to stress resistance, and tends to be related to emotional stability and adaptability. Thus, the psychological profile of students can be used as a predictor of success in completing their education at the faculty of medicine. The attention of the education managers as well as the guidance for the at-risk group of students provided by their academic supervisors should be implemented as early as possible to prepare them to achieve the required competence of a doctor as stipulated by the Indonesian Standards of competence.

## **Acknowledgement**

The researchers wish to extend their sincere thanks to their colleagues, Hernanda MPsi, Laura Sinulingga, MPsi, and Andra, MPsi, for their assistance in administering the psychological test for the respondents of this research.

## **REFERENCES**

- Barbaria, P. Bernheim, S. & Nunez-Smith, M. 2011. Gender and the pre-clinical experiences of female medical students: a taxonomy. *MedicalEducation*, 45, pp. 249-160.



- Creswell JW. *Research design Qualitative, Quantitative, and Mixed Methods Approaches*. 2<sup>nd</sup> ed. London: SAGE Publications. 2003.
- Crolla, E.L. & Bamforth, M.A. 2011. Gender and medicine: the challenges for medical educators. *MedicalEducation*, 45, pp.544-545.
- Dielissen, P. Bottema, B. Verdonk, P. & Lagra-Janssen, T. 2011. Attention to gender in communication skills assessment instruments in medical education: a review. *MedicalEducation*, 45; pp.239-248.
- Menaldi SL. Nani C. Hafiz IZ. Dwi AS. 2009. Profil Mahasiswa Fakultas Kedokteran Universitas Indonesia Angkatan 2008. Fakultas Kedokteran Universitas Indonesia, Jakarta.
- Niemi, P.M. & Vainiomaki, P.T. 2006. Medical students' distress – quality, continuity and gender differences during a six-year medical programme. *MedicalTeacher*, 28, pp.136-141.
- Octaviana, F. 2011. Korelasi Motivasi dan Strategi Belajar terhadap Pencapaian Akademik Mahasiswa Tahun Pertama dan Keempat Fakultas Kedokteran Universitas Indonesia Tahun 2011. Tesis. Program Magister Pendidikan Kedokteran Fakultas Kedokteran Universitas Indonesia, Jakarta.
- Papalia, D.E. Olds, S.W.E. & Feldman, R.D. 2001. *HumanDevelopment*. 8<sup>th</sup> ed. McGraw-Hill, Boston.
- Poerwandari EK. 2009. Pendekatan Kualitatif untuk Penelitian Perilaku Manusia. Jakarta: Lembaga Pengembangan Sarana Pengukuran dan Pendidikan Psikologi.
- Samira, J. 2011. Pengaruh Kekuatan Motivasi terhadap Pendekatan Pembelajaran Mahasiswa Preklinik Semester Genap Fakultas kedokteran Universitas Trisakti Tahun 2011. Tesis. Program Studi Magister Pendidikan Kedokteran Fakultas Kedokteran Universitas Indonesia, Jakarta.
- Santrock, J.W. 2003. *Adolescence*. 6<sup>th</sup> ed. McGraw-Hill, Boston.
- Santrock, J.W. 2009. *EducationalPsychology*. 4<sup>th</sup> ed. Boston: McGraw-Hill.
- Schunk, D.H. Pintrich, P.R. & Meece, J.L. 2010. *Motivation in Education. Theory, Research and Applications*. 3<sup>th</sup> ed. Pearson Education LTD, London.
- Syah, M. 2010. Psikologi Pendidikan. Bandung: Remaja Rosdakarya Offset.
- Tim Konseling FKUI. Data Mahasiswa FKUI bermasalah. 2009. (tidak dipublikasikan)
- Semiawan, C.R. 2009. Kreativitas Keberbakatan: *Mengapa, Apa dan Bagaimana*. Indeks, Jakarta.



*Emotion Regulation: A Critical Review of Cross-cultural Validity of Emotion  
Suppression*

Kullaya Pisitsungkagarn, Phongmanus Busayaprateep

Chulalongkorn University, Thailand

0247

The Asian Conference on Psychology & the Behavioral Sciences 2013

Official Conference Proceedings 2013

Abstract

Investigations of emotion regulation have proliferated over the last two decades. This is due to recognition of the significance of emotion regulation in mental health and well being. Theoretical models and measures of emotion regulation have been proposed. Those proposals, however, are based on studies conducted in Western cultural contexts. With recent empirical and theoretical findings, questions have emerged regarding the cross-cultural validity of emotion regulation strategies. This paper aims to illustrate cross-cultural variations in emotion suppression. Possible explanations for this variation are offered. This critical review should aid in evaluating the generalization of research findings using measures of emotion regulation across cultures. A recommendation for utilizing and developing a culturally appropriate measure of the construct is also offered.

## **Introduction**

During the past two decades, considerable endeavors have been made to study the construct of emotion regulation. This regulation has been shown to have a profound impact on daily living (e.g., psychological adjustment, interpersonal relationships, work performance, and physical health) (Gross 1998). Additionally, ineffective emotion regulation has been identified as being of critical importance in many psychological disorders. Anxiety disorders are maintained by ineffective emotion regulation of avoidance (Barlow 2008). Additionally, the adverse effects of borderline personality disorder have been associated with poor emotion regulation (Barlow 2008). Thus, emotion regulation training is now a core component of various psychotherapeutic approaches. These include mindfulness-based cognitive therapy (Segal, Teasdale, & Williams 2002), acceptance and commitment therapy (Hayes, Kirk, & Kelly 2003), and dialectical behavior therapy (Linehan & Dimeff 2001).

In light of the significance of emotion regulation, increased efforts in research are currently being made toward the development of conceptual frameworks and assessment instruments for the construct. A key theoretical model has been proposed by Gross and John (2003). Subsequently, various measures of emotion regulation have been developed. These include the Emotion Regulation Questionnaire (ERQ; Gross & John 2003), the Cognitive Emotion Regulation Questionnaire (CERQ; Garnefski & Kraaij 2006), the Difficulties in Emotion Regulation Scale (Gratz & Roemer 2004), the Generalized Expectancy for Negative Mood Regulation Scale (Catanzaro & Mearns 1990), Emotion Regulation of Self and Others (Niven et al. 2011), and the Affective Style Questionnaire (Hofmann & Kashdan 2010). Variations exist in the characteristics of the model. These are, for example, the valence of emotion regulated (e.g., measuring exclusively positive or negative emotions or the two combined), the regulation strategies involved (e.g., cognitive or behavioral strategies), and the effectiveness of the emotion regulation measured (i.e., the effectiveness or ineffectiveness of the process).

Despite these variations, the aforementioned measures of emotion regulation have some features in common. One such feature is that they were developed within Western cultural contexts. Although some of these instruments have been translated into various languages, questions have emerged regarding their cross-cultural validity in determining various emotion-regulation strategies. This is evident with the ERQ (Gross & John 2003), which is one of the most recognized measures of the construct.

## **Objectives**

This paper aims to provide an illustration of cross-cultural variations reported in relation to the use of the ERQ. Since it is one of the most researched measures of emotion regulation, a review of its applications across cultures should pave the way for subsequent examination of such variations in other measures. The information obtained should also be beneficial in developing assessment instruments of emotion regulation for use in non-Western cultural contexts.

The current literature review will be organized to reflect the above objectives. In the next section, the theoretical foundation of the ERQ will be outlined. The use of this measure and its psychometric properties will then be reviewed, followed by its hitherto reported cross-cultural variations. Subsequently, potential factors contributing to these variations will be discussed. Finally, the implications for the use of the ERQ

as well as other assessment measures for emotion regulation across cultures will be examined.

### **Theoretical Background for the ERQ**

The ERQ was developed by Gross and John (2003), who proposed a process model of emotion regulation, and it became widely recognized. Based on this model, emotion regulation results in the enhancement of positive effects and mitigation of negative ones. Two phases, which are further divided into smaller stages of regulation, lead to these results. The first phase encompasses the first four stages and is termed antecedent-focused emotion regulation. This phase reflects the emotion-regulation processes that take place prior to the occurrence of an emotion. These include: (1) situation selection, or the individual's decisions whether to engage in or withdraw from situations that give rise to a particular emotion; (2) situation modification, or the individual's efforts to modify the situations at hand in order to affect their emotional experiences; (3) attention deployment, or the individual's decisions to choose which aspects of the situations at hand to attend to in order to affect their emotional experiences; and (4) cognitive change, or the individual's attempts to change their perspectives on the situations at hand in order to change their emotions.

The second phase of emotion regulation is termed response-focused emotion regulation (Gross & John 2003). This covers the fifth stage of this process, which reflects response modulation. This stage refers to the individual's attempts to control their responses to the emotions that have already arisen. Therefore, control may be exercised over these responses (e.g., facial expression, relevant behavior). Response-focused emotion regulation mainly involves suppressing expression of the emotion that has already been established. The regulation is sometimes termed emotion suppression.

### **The ERQ**

Gross and John's theoretical framework on emotion regulation (2003) was the basis for their development of the ERQ (Gross & John 2003), which measures individuals' abilities to regulate their emotions. The ERQ consists of 10 Likert-type items, which are divided into two subscales based on the antecedent- and response-focused phases of emotion regulation. Cognitive change is used to represent the first phase, whereas emotion suppression is employed for the latter; the two subscales that reflect this distinction are termed, respectively, reappraisal and suppression.

The reappraisal subscale consists of six items (e.g., "I control my emotions by changing the way I think about the situation I'm in," and "When I want to feel a positive emotion, I change the way I think about a situation"), and it reflects an individual's abilities to change their emotions (e.g., enhancing positive emotions or reducing negative emotions by changing their perspectives). The suppression subscale consists of four items (e.g., "When I feel positive emotions, I'm careful not to express them," and "When I feel negative emotions, I make sure not to express them"), and it captures an individual's attempts not to express their emotions, regardless of their valences. Respondents select from the seven Likert-type ratings, which range from 1 (strongly disagree) to 7 (strongly agree). According to Gross and John (2003), the higher the score a respondent obtains in a given subscale, the greater the use of the emotion-regulation strategy.

Past findings (Gross & John 2003) have demonstrated satisfactory psychometric properties of the ERQ, with Cronbach's alphas ranging from .75 to .82 for the reappraisal subscale and from .68 to .76 for the suppression subscale. Additionally, the two strategies (Gross & John 2003) lead to different psychological outcomes. Generally, cognitive reappraisal has been shown to be positively associated with factors relevant to well being (e.g., positive effects, life satisfaction, self-esteem, optimism, and psychological well being) but negatively associated with adjustment difficulties (e.g., depression, rumination, and negative effects).

Scores on the ERQ suppression subscale have been shown to be positively associated with vulnerabilities to maladjustment. These include the sense of being inauthentic and rumination as well as anxiety, stress, and depression (Amstadter 2008; Gross & John 2003). In contrast, the attempt to suppress the consequences of emotions is negatively associated with positive affects, self-esteem, life satisfaction, and psychological well being. A sense of frustration and lack of control over one's environments has been reported in relation to these outcomes. Health-wise, physiological changes of emotion suppression in cardiovascular and respiratory systems (Gross & Levenson 1993, 1997) have been posited to affect the immune system. Moreover, adverse effects of emotion suppression have been found in terms of social functioning. People oriented toward emotion suppression suffer disadvantages; they receive less favorable peer ratings (although they are *not* disliked by their peers). It has been reported that a compromised sense of authenticity and openness is experienced by people who interact with individuals that engage in emotion suppression (Butler et al. 2003). The suppression is also described in association with the avoidance of attachment, poor interpersonal coordination, and decreased feelings of rapport (Gross & John 2003). Therefore, emotion suppression is negatively associated with social support (Gross & John 2003) and the sense of affiliation (Butler et al. 2003).

### **Analysis of Cross-cultural Variations in Emotion Suppression**

As seen above, the debilitating effects of emotion suppression have been consistently reported in areas of intrapersonal adjustments, in terms of both psychological and physical health, and in interpersonal relationships. Those reports, however, were drawn from studies of Caucasian participants within a Western cultural context. Possible cross-cultural variations in emotion regulation have begun to emerge since Gross and John's introduction of the ERQ (2003). In their seminal paper, the researchers examined ethnic variations in the use of emotion suppression. Latino-, Asian-, and African-American participants were found to be significantly more oriented toward emotion suppression than European-American participants. Gross and John (2003) noted that this greater orientation was not unanticipated. However, the researchers did not elaborate on their rationale or examine whether variations also existed in the outcomes of emotion suppression across ethnic groups.

Subsequent studies have been conducted to clarify this area. Differences emerge regarding the cross-cultural implications of emotion suppression. Whereas the degree of deployment of cognitive reappraisal and its outcomes remains relatively constant across cultures (Soto, Perez, Kim, Lee, & Minnick 2011), variations exist in the orientation toward emotion suppression and its outcomes. The variations become most apparent when emotion suppression is employed within Eastern collectivistic

cultures. The distinction can be observed in relation to both intra- and interpersonal outcomes of emotion suppression.

In terms of the intrapersonal consequences of emotion suppression, Soto et al. (2011) examined the use of cognitive reappraisal and emotion suppression among Hong Kong Chinese and European-American participants. Similar associations were found between the use of cognitive appraisal and subsequent psychological adjustments (i.e., life satisfaction) between the two groups. However, the consequences of emotion suppression vary across cultures. In concurrence with the findings of Gross and John (2003), Soto et al. found emotion suppression to be associated with adjustment difficulties (i.e., negatively associated with life satisfaction but positively associated with depression) among European-American participants. However, among Hong Kong Chinese who reported greater emotion suppression, Soto et al. found these associations to be absent. Similar findings were reported by Arens, Balkir, and Barnow (2012), who studied emotion suppression among female immigrants in Germany. Turkish immigrants were selected because of the orientation toward collectivism in Turkish culture. Their findings demonstrated that participants with a Turkish cultural background engaged more in emotion suppression than German participants. Interestingly, that engagement did not lead to negative outcomes in psychological adjustment and well being. Similar findings were seen in relation to physical health. Better health outcomes were reported in relation to emotion suppression in Asian collectivistic cultures (Butler, Lee, & Gross 2009).

Likewise, at the interpersonal level, emotion suppression has been found to have less adverse outcomes among individuals oriented toward collectivism. According to a pioneering study by Butler, Lee, and Gross (2007), bicultural Asian-Americans were less affected by the negative consequences of emotion suppression than European-Americans. Among the latter, emotion suppression leads to negative emotions and self-protective goals during social interactions. In emotion suppression, European American participants became less responsive in their social interactions and were perceived by those with whom they interacted as negative and hostile. Interestingly, when bicultural Asian-American participants engaged in emotion suppression, those adverse impacts were absent. Butler et al. (2007) concluded that emotion suppression appeared to be problematic only for participants oriented toward individualism, not those oriented toward collectivism.

### **Potential Explanations for Cross-cultural Variations of Emotion Suppression**

With variations in frequency and outcomes of emotion suppression observed across cultures, cultural orientation has been identified as accounting for the different orientations and outcomes of emotion suppression. Although the exact aspect of culture that accounts for this variation has yet to be identified, two key aspects are often mentioned: cultural orientation toward collectivism and individualism and dialectical beliefs. These may be regarded as follows.

#### ***Cultural Orientation***

Cultural orientation toward collectivism and individualism has been cited as contributing to different interpretations that individuals have regarding emotion suppression. Placing a high value on personal identity and independence, those oriented toward individualism are likely to be averse to emotion suppression: engaging in it hinders their self-expression and assertiveness. Thus, individuals from



individualistic cultures are likely to perceive emotion suppression as compromising their sense of control, less satisfactory, and stress inducing. The suppression has been associated with poor adjustments, both psychologically and physically.

Similar findings have been reported related to interpersonal adjustments with emotion suppression among those oriented toward individualism: given their prime values of self-expression and assertiveness, emotion suppression is not congruent with their sense of self. The suppression is, therefore, perceived as inauthentic and involuntary (e.g., reflecting self-protection) (Butler et al. 2007). The negativity of emotion suppression is also reported by those interacting with such individuals: those partners reportedly experience suppressors as less warm and less genuine, which causes them to interact with hostility to suppressors and offer them less social support. This, in turn, perpetuates the perception of the negativity of the suppression in individualistic cultures.

In contrast, emotion suppression appears more congruent with the collectivistic goals of maintaining social harmony (Hofstede 2001; Markus & Kitayama 1991). The congruence between emotion regulation and collectivistic values of interdependence has been posited as counterbalancing the negativity of emotion suppression (Butler et al. 2003). Concealing one's emotional responses is likely to leave the individual with reduced risk in social discord through expressing negative emotions. Therefore, this emotion-regulation strategy is adaptive in fulfilling prosocial goals (Hui, Triandis, & Yee 1991) and is more acceptable in collectivistic cultures. This potentially helps to explain the reported lack of negative consequences of emotion suppression for such individuals, both psychologically and physically (Butler, Lee, & Gross 2009).

### ***Dialectical Beliefs***

In addition to the cultural dimension, cultural scripts or dialectical beliefs appear to play an important role in alleviating the negative effects of emotion suppression in collectivistic cultures (Miyamoto & Ma 2011). One dialectical belief commonly found in Asian collectivistic cultures is the concept of the “middle way” (Peng & Nisbett 1999). This, together with the concept of transience—the belief that reality, including the emotions, is constantly changing (Osella & Osella, 1999)—is likely to reduce the frustration that individuals have regarding the ineffectiveness of emotion suppression in alleviating negative emotions. Transience is likely to lead individuals to be more accepting of such emotions, viewing them as unstable and likely to change of their own accord. The necessity to change these emotions through active strategies becomes less dominant. In terms of the middle way, this balancing view is likely to leave those with Asian collectivistic values more accustomed to moderated emotions and feel more tolerant of negative emotions (Miyamoto & Ma 2011). The middle way, or the tolerance for contradiction, may also help those with Asian collectivistic values become more flexible in their employment of emotion-regulation strategies (i.e., using emotion suppression in combination with other strategies). This flexibility may help balance out the negative effects of the suppression.



The importance of flexibility is shown in a study by Bonanno, Papa, Lalande, Westphal, and Cofiman (2004). In this study, undergraduate students' abilities in emotion regulation using emotion suppression in combination with other strategies (i.e., emotion enhancement) was found to be a prospective predictor of their adjustments over the next 2 years. Those more able to both enhance and suppress their emotions achieved better adjustment. Similar findings were reported by Arens, Balkir, and Barnow (2012), who found that Turkish immigrants in Germany exhibited both greater emotion suppression and reappraisal than native German females, and they also experienced no negative outcomes of emotion suppression. The absence of this negativity was not found when the Turkish immigrants became depressed. Similar to their German counterparts, depressed immigrants were less flexible in emotion regulation and employed only emotion suppression in emotion regulation. The adverse outcomes of emotion suppression were found in those immigrants when the suppression was not used in proportion with other emotion-regulation strategies.

### **Future Directions: Enhancing the Assessment of Emotion Regulation**

As shown above, various cultural factors could contribute to cross-cultural variations in emotion regulation. Those factors include cultural values and interpreting how well emotion suppression fits one's cultural goals. Additionally, dialectical beliefs play a role and lead to different interpretations of emotion and the manner in which emotion regulation is managed. The use of assessment tools for emotion regulation should therefore take these points into consideration. It is necessary to avoid assuming negative consequences of emotion suppression without taking the cultural background into consideration. Additionally, the suppression should be viewed in conjunction with other emotion-regulation strategies (i.e., cognitive reappraisal) to enhance accuracy when interpreting its outcomes (Arens et al. 2012).

The present review indicates cross-cultural variations in emotion regulation using the example of emotion suppression. It is worth pointing out that variations emerge in other measures of emotion regulation as well. One example is an initial report by Wong (2009) of a higher orientation toward certain cognitive response patterns in the CERQ and their outcomes (Garnesfski, Kraaij, & Spinhoven 2001). Comparing data obtained from Mainland Chinese participants with those previously reported in Western literature, Zhu and colleagues (2008) reported that the Chinese participants were more oriented toward blaming (i.e., self-blaming and other-blaming) in their emotion regulation. In contrast, there was a significantly higher endorsement of planning and positive reappraisal—putting things into perspective—in the American sample. Additionally, different outcomes with the regulation patterns were found with participants from different cultures. For instance, a negative association was found between positive reappraisal (one of the more helpful response patterns) and depressive symptoms in Western studies. However, no such association was evident among Mainland Chinese participants. Subsequent findings in a more rigorously designed study by Wong (2009) confirmed those of previous investigations on different orientations toward emotion-regulation strategies between Hong Kong and North American participants.

Future studies should benefit by taking these cultural variations into consideration with regard to cross-cultural differences in emotion-regulation measures. Toward

developing a new instrument on the construct, empirical evidence should be systematically obtained for interpreting the implications of emotion suppression. Additionally, the measurement of emotion suppression should be considered within the context of other strategies and the cultural context. A new scale should take into account the characteristics of existing measures. These would include the following: (1) the valence of the emotion to be regulated; (2) the regulation processes involved; and (3) the effectiveness of the emotion regulation measured.

### Summary

The present review outlines considerations in engaging in emotion suppression across cultures with the emphasis on the orientation and outcomes of emotion suppression. Whereas past findings reported negative consequences of emotion suppression in individualistic cultures, such adverse effects are not evident in collectivistic ones. An analysis of relevant factors indicated that cultural values and dialectical beliefs lead to different interpretations of emotion suppression and greater utilization of regulation in collectivistic cultures; these factors prevent its negative outcomes. Suggestions for subsequent examination of other emotion-regulation instruments and directions for the development of relevant measures are made.

### References

- Amstadter, A 2008, 'Emotion regulation and anxiety disorders', *Anxiety Disorders*, vol. 22, pp. 211-221.
- Balkir, N, Arens, EA, Wolff, C, & Barnow, S in press, 'Exploring the influence of self construals on psychopathology in Turkish immigrant and German women with major depression', *Psychiatrische Praxis*, vol. 40, no. 3, pp. 135-145.
- Barlow, DH (ed.) 2008, *Clinical handbook of psychological disorders: A step-by-step treatment manual*, 4th ed., Guilford Press, New York.
- Barnow, S, Arens, EA, & Balkir, N 2011, 'Emotion regulation and psychopathology taking cultural influences into account. Psychotherapie in Psychiatrie', *Psychotherapeutischer Medizin und Klinischer Psychologie*, vol. 16, pp. 7-17.
- Bonanno, GA, Papa, A, Lalande, K, Westphal, M, & Coifman, K 2004, 'The importance of being flexible: The ability to enhance and suppress emotional expression as a predictor of long-term adjustment', *Psychological Science*, vol. 15, no. 7, pp. 482-487.
- Butler, EA, Egloff, B, Wilhelm, FH, Smith, NC, Erickson, EA, & Gross, JJ 2003, 'The social consequences of expressive suppression', *Emotion*, vol. 3, pp. 48-67.
- Butler, EA, Lee, TL, & Gross, JJ 2007, 'Emotion regulation and culture: Are the social consequences of emotional suppression culture-specific?', *Emotion*, vol. 7, pp. 30-48.

Butler, EA, Lee, TL, & Gross, JJ 2009, 'Does expressing your emotions raise or lower your blood pressure? The answer depends on cultural context', *Journal of Cross-Cultural Psychology*, vol. 40, pp. 510-517.

Catanzaro, SJ & Mearns, J 1990, 'Measuring generalized expectancies for negative mood regulation: Initial scale development and implications', *Journal of Personality Assessment*, vol.54, pp. 546-563.

Chentsova-Dutton, YE, Chu, JP, Tsai, JL, & Rottenberg, J 2007, 'Depression and emotional reactivity: Variation among Asian Americans of East Asian descent and European Americans', *Journal of Abnormal Psychology*, vol. 116, pp. 776-785.

Garnefski, N & Kraaij, V 2006, 'Relationships between cognitive emotion regulation strategies and depressive symptoms: A comparative study of five specific samples', *Personality and Individual Differences*, vol. 40, pp. 1659-1669.

Gratz, KL & Gunderson, JG 2006, 'Preliminary data in an acceptance based emotion regulation group intervention for deliberate self-harm among women with borderline personality disorder', *Behavior Therapy*, vol. 37, no.1, pp. 25-35.

Gross, JJ 1998, 'The emerging field of emotion regulation: An integrative review', *Review of General Psychology*, vol. 2, no. 3, pp. 271-299.

Gross, JJ & John, OP 2003, 'Individual differences in two emotion regulation process: Implications for affect, relationships, and well-being', *Journal of Personality and Social Psychology*, vol. 85, pp. 348-362.

Gross, JJ & Levenson RW 1993, 'Emotional suppression: Physiology, self-report, and expressive behavior', *Journal of Personality and Social Psychology*, vol. 64, pp. 970-986.

Gross, JJ & Levenson RW 1997, 'Hiding feelings: The acute effects of inhibiting negative and positive emotion', *Journal of Abnormal Psychology*, vol. 106, pp. 95-103.

Hayes, SC, Kirk, DS, & Kelly, GW 2003 *Acceptance and Commitment Therapy: An experiential approach to behavior change*, Guilford Press, New York.

Hofmann, SG & Kashdan, TB 2010, 'The Affective Style Questionnaire: Development and psychometric properties', *Journal of Psychopathology and Behavioral Assessment*, vol. 32, pp. 255-263.

Hofstede, G 2001, *Culture's consequences: Comparing values, behaviors, institutions, and organizations across nations*, 2nd ed., Sage Publications, Thousand Oaks.

Hui, CH & Harry, CT 1986, 'Individualism-collectivism: A study of cross-cultural researchers', *Journal of Cross-Cultural Psychology*, vol. 17, pp. 225-247.

Hui, CH, Triandis, HC & Yee, C 1991, 'Cultural differences in reward allocation: Is collectivism the explanation', *British Journal of Social Psychology*, vol. 30, pp. 145-157.

Linehan, MM & Dimeff, L 2001, 'Dialectical Behavior Therapy in a nutshell', *The California Psychologist*, vol. 34, pp. 10-13.

Markus, HR & Kitayama, S 1991, 'Culture and the self: Implications for cognition, emotion, and motivation', *Psychological Review*, vol. 98, no. 2, pp. 224-253.

Miyamoto, Y & Ma, X 2011, 'Dampening or savoring positive emotions: A dialectical cultural script guides emotion regulation', *Emotion*, vol. 11, no. 6, pp. 1346-1357.

Ochsner, KN, Ray, RD, Cooper, JC, Robertson, ER, Chopra, S, Gabrieli, JDC, et al. 2004, 'For better or for worse: Neural systems supporting the cognitive down-and-up regulation of negative emotion', *Neuro Image*, vol. 23, pp. 483-499.

Osella, F, & Osella, C 1999, 'From transience to immanence: Consumption, life-cycle and social mobility in Kerala, South India', *Modern Asian Studies*, vol. 33, no. 4, pp. 989-1020.

Segal, Z, Teasdale, J, & Williams, M 2002, *Mindfulness-based cognitive therapy for depression*, Guilford Press, New York.

Soto, JA, Perez, CR, Kim, Y, Lee, EA, & Minnick, MR 2011, 'Is expressive suppression always associated with poorer psychological functioning? A cross-cultural comparison between European Americans and Hong Kong Chinese', *Emotion*, vol. 11, no. 6, pp. 1450-1455.

Wong, KYM 2009, *A cultural comparison of cognitive emotion regulation strategies: Moderation of cultural values on psychological well-being*, unpublished dissertation, City University, Hong Kong, Department of Applied Social Studies.

Zhu, X, Auerbach, RP, Yao, S, Abela, JRZ., Xiao, J, & Tong, X 2008, 'Psychometric properties of the cognitive emotion regulation questionnaire: Chinese version', *Cognition and Emotion*, vol. 22, pp. 288-307.

*Altruism among Teacher*

Reza Olitalia, Erik Wijaya, Khadijah Almakiyah, Laksmiari Saraswati  
Tarumanagara University, Indonesia

0258

The Asian Conference on Psychology & the Behavioral Sciences 2013  
Official Conference Proceedings 2013

Abstract

Altruism is an important aspect in a teacher. Altruism is an attitude to pay attention on other's well-being without concerning the self (Batson, 1987). Teachers need to pay more attention on their students' well-being rather than their personal well-being. Altruism, based on Batson (1987) consider motivations for benefiting others, altruism is a way that includes benefiting another as a means to benefit oneself, as long as the self-benefits are internally rather than externally administered. This research is aimed at obtaining teachers altruism in Jakarta associated with the teachers' attitude toward their students in education. Connectedness is measured based on a) duration of relationships, b) frequency of interaction, c) knowledge of the other person's goal, d) sense of intimacy, e) self-disclosure to others, f) familiarity to others (Starzyk et al, 2006). The result reflects altruism and connectedness in teachers' attitude in education in Jakarta. Discussions include considerations on educational program.

**Keyword:** altruism, teachers, connectedness, education



The development quality of a nation depends on the quality of human resources of its people, and the human resource quality depends on the quality of education

The objectives of educating and developing the nation quality are the mission and responsibility to be accomplished from every professional teacher in Indonesia (Dimiyati, 2002). There are various problem found in Indonesia's education, such as the declining of students moral (juvenile delinquency, school fighting), less unequal learning opportunities, low internal efficiency of the education system, status of educational institutions in Indonesia are not applying, educational management in line with national development, and unprofessional human resources engaged in education (Nurhadi, 2004). Thus, the impact of which can be observed is the result of unsatisfactory and poor education.

The Indonesian education facts are need to be concerned (Stevanus & Mulat, 2005). With these reasons, Jakarta Education Government conducts a symposium for Jakarta's area teacher, with the Education With Heart topic. It aim is to improve the conditions of teachers to be more professional in teaching and using the "conscience". Thus, the phenomenon of declining morals learners can overcome after the teachers get the new knowledge about educate with heart & awareness. The second aim is to make a descriptive research about the psychological altruism motivation of their own, because as the heart of education, teacher supposed to have the altruism quality, as caring is one of the factors to increase the student's school connectedness.

Teacher is a profession that has its job description to be an inspiratory, motivator, organizer, initiators and facilitator (Djamarah, 1997). To be a teacher as a professional job, need an intense motivation. There are two motivations in teacher, the extrinsic and intrinsic motivation. The extrinsic motivation rewards are as seen in public, external attraction of occupation, such as money, prestige, and power. The intrinsic motivation rewards are internal psychic and spiritual satisfaction from one's work, such as personal sense of accomplishment or an enjoyment of the work itself (Parkay, 2013).

One of the most important reasons one's choosing a teacher profession is to have a desire to serve. Parkay (2013) said that a teacher wants their life's work to have meaning, to be more than just a job. Teacher profesion characteristic is a job that motivated by the need to help others, instead of the financial needs (Stinnett, 1968). Altruistic is one of the characters to be desire in a teacher.

Scott and Dinham (1999) stated that the strongest motivational factors for teachers are altruism, commitment and personal improvement. Altruism is a concept used for identifying individuals who are self-sacrificing and directing their concern toward others. According to some theoreticians, altruism is helping others without an external award (Macaulay & Berkowitz, 1970). Mayers (1993) defined altruism as helping others without any expectations and concerning others. Altruism as caring for no obvious reward other than the belief that someone else will benefit or avoid harm (Fung, 1988). Altruism represents an amalgamation of intrinsic and extrinsic factors which either permit or coerce individuals to take responsibility for or care for another and to sacrifice things dearly held. Traditionally the caring professions have been characterized by a self-professed altruism, that is, a selfless service on behalf of or for others (Thompson et.al, 1994).



Altruism is also acting morally. It is a specific set of helpful acts-those that meet some standard of goodness or morality. The link between altruism and morality appears to be based on the juxtaposition of each to self-interest, as helping in order to gain internal rather than external rewards. Altruism, based on Batson (1987) consider motivations for benefiting others, altruism is a way that includes benefiting another as a means to benefit oneself, as long as the self-benefits are internally rather than externally administered.

According Batson theory (1987) altruism is a helping behavior which have two basic motivation. First is an empathic concern, the motivation of reducing the difficulties of others and sympathy for the troubles of others. Second, personal distress is a concern for any inconvenience oneself in the face of difficulties of others and motivation to reduce tension or discomfort.

In school setting as a teacher there's no day without altruistic behavior needed. Altruism and its motives seem to permeate the teaching profession itself. Mateur (1993) said that in everyday teaching profession there are countless work such as reports and stories about teachers working after-school hours tutoring struggled students, providing advice or even comfort to students in challenging situations, and willing to do these things despite a low standard wage. Teachers were overwhelmingly concerned with the needs of their students, and they were willing to address these needs, being focused on intrinsic rewards, not material extrinsic rewards.

Connectedness appears to be related to one's opinion of self in relation to other people. In particular the scale focuses on the emotional distance or connectedness between the self and other people, both friends and society, taps those aspects of belongingness that Kohut (1984) describes as an "intense and pervasive sense of security" and the sense of being "human among humans. A sense of teacher's connectedness is one of the most important factors in promoting socio-emotional well-being and positive youth development (Stracuzzi & Mills, 2010).

Strong scientific evidence demonstrates that increased student connection to school decreases absenteeism, fighting, bullying and vandalism while promoting educational motivation, classroom engagement, academic performance, and school attendance and completion rates. In order to succeed, students need to feel they "belong" in their school (Stracuzzi & Mills, 2010). In the value of connections theory, school connection is the belief by students that adults in the school care about their learning and about them as individuals. Students are more likely to succeed when they feel connected to school. Individual students who perceive their teachers and school administrators as creating a caring, well - structured learning environment in which expectations are high, clear and fair are more likely to be connected to school. Increasing the number of students connected to school is likely to improve critical accountability measures (Blum, 2004).

There are seven qualities that influence students' positive attachment to school: having a sense of belonging and being part of a school, liking school, perceiving that teachers are supportive and caring, having good friends within school, being engaged in their own current and future academic progress, believing that discipline is fair and effective, participating in extracurricular activities (Blum, 2004).

While each has its own nuance, school connectedness is influenced through the interaction of three dynamic concepts and relationships; first, Individuals (students

and school staff), second thing is Environment (School climate and school bonding), third thing culture: social needs and school learning priorities. Relationships formed between students and school staff members are at the heart of school connectedness (Blum, 2004).

This research is aimed at obtaining teachers altruism in Jakarta associated with the teachers' attitude toward their students in education. Connectedness is measured based on a) duration of relationships, b) frequency of interaction, c) knowledge of the other person's goal, d) sense of intimacy, e) self-disclosure to others, f) familiarity to others (Starzyk et al, 2006).

## Measurements

### Respondents/Participants characteristic and research methods

The research respondents are the Jakarta teachers (preschool to high-school teacher) who attend a national symposium in Jakarta on November 29<sup>th</sup> 2012. The symposium is held by the corporation Jakarta Education Government and KataHati Institute, with the theme of 'The awareness to educate with heart'. 714 questionnaires are to be filled by the teachers who attend to the symposium. The research design is quasi experiment (non-experimental) with convenience sampling. The reasons, that the research samples are accordance to the existing research on the current symposium.

## Results

The research results are analyzed with the SPSS Statistic Programs. From 714 respondents, the altruism among teacher are above average. The empiric mean is higher than the hypothec mean (hypothec mean = 3, with Likert scale 1-5). The empiric mean is 3,1491, with the specific of emphatic concern dimension is high (4,0373) and personal distress dimension is low (2,2609).

**Table 1**

### Respondents' altruistic description

Altruism	Empiric Mean	Hypothetic Mean
Altruism variable	3,1491	3,00
Emphatic Dimension	4,0373	3,00
Personal Distress Dimension	2,2609	3,00

### Altruism variable analysis from various data control

In this research, with the aim to correlate with the connectedness variable, the researchers use the control data to analyze the differential measurement from the respondents. The differential testing from various measurements are to be reviewed from the altruistic level of respondents. The data control aspects are gender differences, teaching level, education level, teaching experiences, income, interactions media with students, discussion topics with students, and the frequency interaction with students. The results can be seen in the table below

**Table 2**  
**Altruism differential measurement/test from Control Data**

Differential Test	Mean Difference	Test	Sig (p)	Explanation
Gender	Male (3,1697)	t = 1,200	0,230	Not significant
Education level	Primary education (3,1876)	F = 13,220	0,000*	Significant
Educational background	Doctoral (3,3460)	F = 0,991	0,435	Not significant
Teaching experience	16-20 years (3,2405)	F = 2,567	0,007*	Significant
Income	15-20 million rupiah/month (3,6255)	F = 1,825	0,122	Not significant
Interaction media	Other (3,1653)	media F = 0,092	0,912	Not significant
Discussion topic	Other (3,2154)	topics F = 1,754	0,137	Not significant
Frequency Interaction	Other (3,2297)	F = 5,846	0,001*	Not significant

**The Altruism Frequencies**

From the data processing results, there are 477 respondents classified to have a high altruism level (66,8%) and the 237 respondents to have low altruism level (33,2%). This classification obtain from classified the altruism mean of the respondents; >3,00 = high, 3,00 = average, <3,00 = low. The results are in the table below.

**Table 3**

**The frequencies of altruism level classification**

<b>Altruist level</b>	<b>Frequency</b>	<b>Percent</b>	<b>Valid Percent</b>	<b>Cumulative Percent</b>
Low	237	33.2	33.2	33.2
High	477	66.8	66.8	100.0
Total	714	100.0	100.0	

**Other Analyzing Results**

The last part of the questionnaire is the inquiry with open ended answer from the respondents. The answers are classified from the similarity of the responds, and then given the number code. The coding is needed by the researcher to give other description of the research results. The inquiries are; (a) What is your expectation in the future of Indonesia education?, (b) What facilities or compensation to be expected from the Indonesia government?

From 714 questionnaire, there are 172 are not filled. The first results are 257 respondents (36%) expecting a change in moral education and character and at least those who expecting the change in curriculum (moral education and character) and facilities 5 respondents (0,7%). The moral education and character for the purpose of the self-improvement students highlight include: moral, character, awareness, religion, manners, Indonesia cultures, Pancasila (Indonesia's national icon), ethics and changes in student behavior.

The second result, 714 respondents, 249 are not filled. The most answer are the need of individual teaching support, 147 respondents (20,6%) and the least are 1 respondents (0,01%) in self-development. The individual teaching support needs, are about the material supporting individuals. It includes; allowance, certifications, health care, welfare, housing, transportation, salary increases, retirement benefits, on time salary payment, school allowance.

**Conclusion**

From the results we conclude that the altruism among teacher in Jakarta as the capital city of Indonesia are high (3,1491). This results has the strong evidence of the mean of its two dimension of the high score in personal distress (4,0373) and low in emphatic concern (2,2609). The analysis are that teachers have high empathy because of their devotion as a teacher, not as the pressure to help the students.

## Discussion

Altruistic is a characteristic to be expected in every teacher. All of this time, Indonesia's government assumed that the declining of moral in students such as bullying and school fighting are the responsibility of their own teacher at school. The background of symposium is also because Indonesia's government wants to educate the teacher to be more loving and caring, so they can be a teacher who teach with awareness from their heart, with the hope when the teacher teach, they also transferred the good communication with the students. But this research results describes that the score of teacher altruism level are high, and they have the connectedness with their students. The assumed from Indonesia's government about Jakarta's teacher does not fit.

Teachers who teach the primary school (from toddler to elementary) have the highest altruism among all. To fit the job description of this level of profession requires more caring knowledge, skills and abilities, because students at this level still needs adults for their dependency supervision. Their dependency caused by their stage of development, they still in the early development stage.

The highest altruism teachers are also to those who work as teacher for 16 to 20 years. In this group, the teachers age range between 35 to 45 years. In human development, these age ranges to those who were in the late young adulthood and early middle adulthood. The issues are generativity versus stagnation. The generativity people are the caring people, their self-actualization are developing by developing their self. It can be expressed by caring its own child or grandchild, mentoring others, teaching others, productivity or creativity, re-generate them self, and still doing the activity to enhance their personal growth (Papalia, Old & Feldman, 2007).

The altruism teacher who spent others time with their students are at their highest level of altruism. These teachers are able to spend their time to the students without no frequencies boundaries and rules. Furthermore data taken from the inquiry section, generally said those teachers (altruistic teacher) asked for changes in increasing moral education section, and supporting teaching and individual material equipment. It includes benefits, training, health benefits, housing, transportation, salary increase, etc.

The altruist teacher that have the connectedness with their students can be the protective factor for students, which in resiliency theory the protective factor is the importance factor to build the resiliency in school, teacher, and self. Resiliency is an interaction process between the individual factor with the environment (Banaag, 2002). Resiliency is the capacity to adapt successfully in the face of threats or disaster. People can improve their capacity for resilience at any time of life (Grotberg, 1993).

Automatically, the teacher with altruist and connect with their students became the protective factor in students and school. Resilience (Grotberg, 1993) is a basic human capacity, nascent in all children. Parents and other care givers promote resilience in children through their words, actions, and the environment they provide. Adults who promote resilience make family and institutional supports available to children. They encourage children to become increasingly autonomous, independent, responsible, empathic, and altruistic and to approach people and situations with hope, faith, and trust. They teach them how to communicate with others, solve problems, and successfully handle negative thoughts, feelings, and behaviors. Children themselves increasingly become active in promoting their own resilience. Children need these

abilities and resources to face many common - and some not so common - crises (Grotberg, 1993).

When the altruist teachers have the connectedness with their students, they build students resilience, and its impact to the school resilience. One of the characteristic of resilience school is able to become the protective factor for their students. When teachers develop their altruist characteristic in school environment and have the connectedness with the entire school element; students, partner, school staff and parents, then the resilience school are build. With resilience school, the entire elements have the extra protective solid factor, and it will give big impacts in child development, especially children with troublesome background.

What's next after we can create the resilience students? We create the student school connectedness. When students feel their caring teacher, they feel connected with them as individuals. And after they feel connected with the individuals, they will feel connected with the institutions. So with this link, we hope we can create a better future, a world who filled with love and positive connections. Teachers are the heart of education. They are the tools to facilitate the development of a nation. They should be the role model of educating with love, compassion and caring without limits, if we want to make a better generation.

iafor

### **Limitation**

There are limitations of this research. It is the connectedness variable correlation with the altruism variable can only be explored from control data. For further research, the connectedness variable can be explored within its theory and the specific measurements.

### **Recommendations for Ministry of Education and Culture**

The recommendations for Indonesia's Ministry of Education is to do a further research to explore the case of the declining moral of Indonesia's students, and it doesn't fit with the research result if the early assumed is teacher ineffectiveness communication in teaching that caused it. As the results is teacher having a high altruism characteristic, there are other evidence can be explore to find its cause.

Other recommendation is to give more attention to teacher well-being, where their well-being has a high impact and significant effect to maintain their altruism.

The increasing of well-being and benefits are not always in material, but the value of appreciation that are needed. There are training or skill enhancement needed for teachers own personal development for their self.



### **Recommendation for further research**

The recommendation for further research is to develop a measurement with connectedness variable with the connectedness theory. Its purpose, to develop the connectedness variable exploration and its the correlation with altruism and other social elements and variable.

### **References**

- Batson, C. D. (1987). Prosocial motivation: Is it ever truly altruistic? In L. Berkowitz (Ed.), *Advances in experimental social psychology* (Vol. 20, pp. 65-122). New York: Academic Press.
- Banaag, C. G. (2002). Resiliency, street children, and substance abuse prevention. *Prevention Preventif*, Nov. 2002, Vol 3.
- Blum R. (2004). School Connectedness, Improving student's lives. *Journal of School Health*. Centers for Disease Control and Prevention, Division of Adolescent and School Health.
- Dimiyati, & Mudjiono. (2002). *Belajar dan pembelajaran* (edisi ke-2). Jakarta: Rineka Cipta.
- Djamarah, S. B. (1997). *Strategi belajar mengajar*. Jakarta: RinekaCipta.
- Fung C. (1988). Is altruism a vice? *Journal of American Medical Association*. November 4, 1988, Vol 260, No. 17.
- Grotberg, E., (1993). Promoting resilience in children: A new approach. University of Alabama at Birmingham: Civitan International Research Center.
- J. Macaulay (Editor), Leonard Berkowitz (Editor. (1970). *Altruism and Helping Behavior*. New York: Academic Press Inc.
- Myers, D. G. (1993). An attitude of gratitude. *The Banner*, pp. 14-15.
- Norma H. Mateer (1993). *Altruism in Teachers: An Exploratory Study*. Penerbit: Pennsylvania State University
- Papalia, D. E., Wendkos-Olds, S., & Duskin-Feldman, R. (2007). *Human development*. New York: McGraw-Hill.
- Parkay, F., W. (2013). *Becoming teacher*. Upper Saddle River, NJ: Pearson
- Starzyk, K. B., Ronald R. H, and Leandre R. F. (2006), "The Personal Acquaintance Measure: A Tool for Appraising One's Acquaintance With Any Person", *Journal of Personality and Social Psychology*, 90, 833-847.

- Stevanus, I., & Mulat, S. P. E. (2006). Sikap guru sd majelis pendidikan katolik keuskupan agung Jakarta terhadap pelaksanaan kurikulum berbasis kompetensi. *Psiko-Edukasi. Jurnal Pendidikan, Psikologi, dan Konseling*, 3(2). 128-145.
- Stinnett, T. M. (1968). *Turmoil in teaching: A history of the organizational struggle for America's teachers*. New York, NY: Macmillan.
- Thompson E. I., Melia M. K., Boyd M. K. (1994). *Nursing ethics* 3<sup>rd</sup> edition. Edinburgh, NY: Churchill Livingstone.
- Kohut (1984). *Contributions to self-psychology*. Paul E. Stepansky and Arnold Goldberg (Ed.), Hillsdale, NJ: The Analytic Press.
- Nurhadi, (2004). *Kurikulum 2004: Pertanyaan dan jawaban*. Jakarta, Ina: Grasindo.
- Nena F. Stracuzzi, Meghan L.Mills (2010). *Teachers Matter: Feelings of School Connectedness and Positive Youth Development among Coös County Youth*. <http://www.carseyinstitute.unh.edu/publication/policyarea/508>. University of New Hampshire.

The logo for the International Association for Frontiers in Psychology (iafor) is centered on the page. It consists of the lowercase letters 'iafor' in a light blue, sans-serif font. The logo is partially enclosed by a large, light blue circular arc that starts from the bottom left and curves towards the right. A red circular arc is also visible, starting from the top left and curving towards the right, overlapping with the blue arc.

*Dealing with Emotional Crisis: A Phenomenological Exploration of Thai Helpers' Perception and Experiences*

Nattasuda Taephant, Arunya Tuicomepee, Supapan Kotrajaras

Chulalongkorn University, Thailand

0263

The Asian Conference on Psychology & the Behavioral Sciences 2013

Official Conference Proceedings 2013

Abstract

The objective of this research is to study experiences regarding emotional crisis of Thai undergraduates from the perspectives of psychological helpers. Phenomenological research method was utilized in this investigation. Twelve key informants who have provided psychological supports to undergraduate students who went through emotional crises participated in this research study. Interview data was verbatim transcribed, coded, and analyzed. Major themes regarding the experiences of crisis were identified as: situational interpretation that leads to the crisis perception, behavior responses signifying crisis distress, unhelpful thinking patterns, coping strategies, the needs for social support, environmental factors perpetuating the distress, and post-traumatic growth. Implications of these findings are offered regarding the significance of providing those undergoing the crisis with supporting systems, assisting them to create their own coping resources, and strategies in supporting those under this condition.

## Introduction

Emotional crisis is a state of the mind that signifies the suffering caused by the feeling of insecurity from the environments, personal dilemmas, or psychological distress. Past literature has indicated that some of the tragedies/negative life events happening to students, especially those in a university level, cause severe distress and emotional crisis. Person in severe stress and emotional crisis may have difficulty in studying, maintaining social life, and cultivating interpersonal relationship (Abdulghani 2008; Benton, Robertson, Tseng, Newton, & Benton 2003; Hyun, Quinn, Madon, & Lustig 2006, 2007; Lucus & Berkel 2005; Ramasooth 2004). Scholars concluded that stress and emotional crisis have been related to academic problems, coping strategies, and happiness and psychological well-being. In Thailand, Sukkapan, Tungtanathanit, Sararat, and Sutasanajinda (2006) studied stress and mental health of sixty college students in a university in North Eastern of Thailand. The researchers identified stressors for these students as academic difficulties, financial problems, and personal problems. A better understanding about psychological experiences of those who were in the crisis would be beneficial to the development of both preventative and intervention measures. The objective of this research is therefore to study experiences regarding emotional crisis of Thai undergraduates from the perspectives of psychological helpers. Phenomenological research method will be utilized in this investigation.

## Method

### *Participants*

Researchers used a snowball sample technique to recruit participants for this research. They were twelve participants participating in this research study. The participants represent a reasonably homogenous, purposive sample. They were all working in higher education institutes and provided psychological supports to undergraduate students who went through an emotional crisis. At the time of the interview 10 participants are counseling psychologists, and 2 of them are academic advisors.

### *Procedure*

Data was collected through semi-structured interviews. Each participant was interviewed individually by research assistants. The research assistants were graduate students in a counseling psychology program. All of them had an experience in conducting qualitative research. They have been trained by the researchers for three, each for two hours long. The training included explaining about overall research project, introducing interview and probing questions, and practicing interview questions. The interview questions were “1) Could you describe your perception on student’s emotional crisis?”, “2) What influences emotional crisis?”, “3) Could you describe what happen to student when they are in crisis?”, and “4) What factors are related to emotional crisis and how?” The interviews were 40 – 90 minutes long. The interview data was verbatim transcribed, and then rechecked to ensure that the transcripts were correctly matched with the recorded. Afterwards, the verbatim transcripts serving as the raw data for the study were coded and analyzed.

### *Trustworthiness*

Researchers establish trustworthiness of the research via method suggested by Lincoln and Guba (1985) as employing data triangulation, investigator triangulation, peer debriefing, negative case analysis, and providing audit trail.

### **Analysis**

Major themes regarding the experiences were identified as: *situational interpretation that leads to the crisis perception, behavior responses signifying crisis distress, unhelpful thinking patterns, coping strategies, needs for social support, environmental factors perpetuating the distress, and post-traumatic growth*. Details of each category are described as follows.

#### *Situational interpretation that leads to the crisis perception*

The participants identified circumstances in which students perceived as unmanageable. Students recognize that such events or circumstances are important and have major impact on their lives. These circumstances can be divided into 3 themes; *having academic difficulty, having interpersonal relationship difficulty, and environmental effect*. Participants shared that *having academic difficulty* impacted students significantly. As quoted from participant 5 "*the key is...when student comes here because he cannot understand what he read, and do not know what to do with it. I'm sure that I won't pass the exam, fear to fail*". Participants also shared that *having interpersonal relationship difficulty* significantly impacts students' emotions. The interpersonal relationship included relationship with significant others, family members or friends. A quote from participant 3 reflects this, "*For example is the case of the girl dumping her boyfriend. This is a crisis for the boy. He was in crisis. His academic performance went downhill. He put his life in danger, wanting to hurt himself and his girlfriend.*" The last one was *environmental change*. Participants indicated the effect from the environment to students related to students' emotional crisis. "*...the crisis situation, like, students from Southern provinces, or when the Tsunami hit, or the unrest situations in the Southern border, parents were killed and [the student] became an orphan in one day...*"

#### *Behavior responses signifying crisis distress*

Beside of the situation, participants also indicated students' behavior during the crisis. Participants observed the behavior cues from students in crisis while they were working together. *Behavior responses signifying crisis distress* consisted of three themes: *Isolation from the society, lack of interest in learning or a decline in academic performance*, and *self-injured*. For the first theme, *Isolation from society*, participants noticed that students in crisis seemed to withdraw from peer groups, family or even the helpers themselves sometimes. Indeed, at that stage, the student seemed to withdraw from everything, declining to communicate with others. Participant 1 stated that, "*If he has emotional problems, he is separated himself from friends. I can see the way he withdraws from others by not communicating...*". Participants were able to observe withdrawal behaviors in classroom and got information from friends. As for the *Lack of interest in learning or academic performance decline*, participants mentioned their identification of students in emotional crisis from their classroom behaviors. Even when these showed up in class, they appeared inattentive to class materials, just sitting still in class but failing to



focus. *"Students in emotional crisis, they rarely studied. They skip class. Even though he might show up in class but they are quite distracted. He was just burning the time."* The last theme under *behavior responses signifying crisis distress* was *self-injured*. *Self-injured* varied from the minimum level of punching the wall, cutting, and hitting his/herself. As participant 6 stated, *"When his girlfriend broke up with him, he had a suicidal thought... hurting himself with a glass bottle. Some might get drunk. This way it will be negative, he incriminates herself."*

#### *Unhelpful thinking patterns*

The participants also recognized unhelpful thinking patterns of students in emotional crisis. Students might evaluate the situation they face as things that go beyond their abilities. They tried to cope with the situations but nothing helped. Therefore they evaluated the situation as unmanageable. This was the first theme under *unhelpful thinking pattern*, *Evaluated situation as unmanageable*. According to participant 4, *"Some students could not see light at the end of the tunnel. There is nothing outside the limits of this life. They had been trying so many things. They saw only limitations. They could see things beyond the limitation. They just knew they had no choice in that time"*. The unhelpful thinking pattern also included *projection*. Students might try to get an explanation about the situation related to emotional crisis by projecting all false to others. As participant 6 stated *"She denied and rejected what she had to face. She used many methods such as blaming others, blaming professors, blaming boyfriends, blaming other things..."* Not only did the theme *Evaluating situation as unmanageable and projection* emerge, the participants also perceived the points of view of students who are in emotional crisis as *pessimistic*. Students tended to see things in the dark side and were likely to interpret everything in a negative tone. As participant 3 stated *"he interpreted everything, like his friend's reaction to himself-- when his friend says no to him or when the friend is unavailable to chat. Other people might think it's ok. But for him, he feels like the whole world reject him. Everything collapses. This is very painful. His friend is not good to him. He sees everything from the pessimistic view, nothing good at all. His mom is not good. His friends are not good."*

#### *Coping strategies*

Participants identify problem solving strategies utilized by students in emotional crisis as themes relevant to *active coping*, *avoidant coping*, and *seeking support from others*. For the first theme, *active coping* was defined as the process which with students in emotional crisis used to deal with problem encountered. For example, participant 1 mentioned about when her client was seeking for more information in order to deal with his problem better, *"This case was tried to search for a solution, in order to make himself getting over the feeling he had."* The second theme was *avoidant coping*. Participants perceived that some students tried to avoid coping with the problem. Some repressed the feelings they had. Some students tried to get distracted, ignoring the problems and trying to have fun with friends. As quoted from participant 1 *"...Some students just rush out from problems, trying to press them. Then turned to other matters, such as trying to forget about the stressors..."*. Some students just withdrawn from school because he tried to avoid coping with the problems as participant 5 stating, *"He did not choose to do so, he just tried to run away. He never came back to it."* The last coping strategy was *seeking support from others*. Students in emotional crisis sought help from others around them; namely, friends, instructors,



academic advisors, or professional helpers. As quoted from participant 5 "...when he is in crisis. He has tried so many things. He didn't know what to do next, so he asked for help..."

#### *Needs for social support*

The fifth category that explains the experiences of students in emotional crisis from helpers' perspective was the need for social support. Students appeared to wish to obtain support from others. If these needs can be fulfilled, they are likely to help them to cope with the problems better. These needs were the needs for emotional and cognitive support. Emotional support was quite important for students in emotional crisis for they need to have someone who cares, who is able to understand them, and does not judge them. As participant 4's quoted "...They want to have someone who listen to them, who can be there with them. Some students know what he supposes to do to solve the problem. But he doesn't have the courage to do so. He has no one. So he is too scared to deal with the problem." Cognitive support was also important for students in emotional crisis. When students were in crisis, they need someone who can guide them. Even they had cognitive ability, but during the crisis they might not be able to maintain their cognitive strengths they possess, "like he doesn't see the problem clearly...some students want someone to clarify the problem..."

#### Environmental factors perpetuating the distress

Environmental factors were significant for students in emotional crisis because they could exert both constructive and destructive influence. The environmental factors perpetuating the distress included family, friends, and instructors. For the first theme, family was the most significant factor. If student had supportive family, he/she is likely to be able to adjust to any problems. As quoted from participant 7 "...in some cases, he has a family who understands him. It is very helpful. But in some cases, he has a family who aggravates the situation. So this is the role of family. Instead of helping student, they make it worse...". The second factor was friend. Due to the developmental stage of college students, friends are important to them. Students were very close to their friends. So friends were in the position that could help them and understand them. As participant 7 mentioned, "...mostly friends are very helpful. When students have problems, friends are very supportive. But in some cases, the person doesn't have a supportive friend. That's very difficult...". The last factor was instructors. Students were in college or university. Instructors had an opportunity to see students regularly. So instructors were one of the closest supportive factors that students could access. If instructors paid attention to students in class, they could notice that a particular student might be in a crisis. Then they would be able to refer the student to professional helpers". As quoted from participant 11 "...some cases were referred from instructors. The instructor observed students in class. He/she noticed that the student seems depressed ..."

#### Post-traumatic growth

After students got through emotional crisis, they had a positive change. They obtain growth psychologically and cognitively. They also changed their behaviors. They learned from their experiences. Post-traumatic growth consisted of three themes that were *accepting the reality*, *learning from past experience*, and *having energy*. For *accepting the reality*, participants were able to see that students were able to be with the reality. Once students were able to accept the reality, they are less likely to fall

into a vicious loop of emotional crisis again. As participant 5 quoted, "...He has his own life. He is happy. Because he understands that, "this is it". His girlfriend is just like this. Things were bad in the past because he had tried to change it. But he can not change others ...". The second theme, *learning from past experience*, students learned the effective coping strategies when they tried to cope with emotional crisis. When they had problems again, they were able to use appropriate strategies. "...past experience is very helpful. If students had an experience to deal with problem, they would learn something ...". The last theme was having energy. Students who got through crisis, obtain changes. They had energy when they do things. Their nonverbal also changed. Even they were in the same environment, they were livelier. They were able to smile and enjoy life. For school, they had more responsibility. They also had better relationship with parent and friends. As participant 1 stated "...He/she able to be with friends. He/she laughs wholeheartedly....In the past he/she separated his/herself from friends. Now he/she has friends....."

## Discussion

The experiences of students with emotional crisis from helpers' perception were identified as seven major themes which are *situational interpretation that leads to the crisis perception, behavior responses signifying crisis distress, unhelpful thinking patterns, coping strategies, the needs for social support, environmental factors perpetuating the distress, and post-traumatic growth*. Circumstances in which students perceived as unmanageable is significant relate to emotional crisis, especially, the circumstances that have major impact on their lives. They might have difference perceptions on circumstances; some might perceive failing exam as significant event, some might not. So psychological helpers should understand students' perception regarding circumstance they face. The *situational interpretation that leads to the crisis perception* can be explained by concept of secondary appraisal (Lazarus & Folkman, 1984). Students evaluated the circumstance as unmanageable circumstance. Students also employed both problem focused and emotional focused coping. But they still evaluated their circumstance as unmanaged. While they were trying to cope, they also evaluated their environment. Environmental factors were significant for students in emotional crisis. They could exert both constructive and destructive influence. If students had support from others, either emotional or cognitive support, they tended to cope with the problem better.

For *post-traumatic growth*, this finding related to concept of posttraumatic growth by Calhoun and Tedeschi (2006). Posttraumatic growth is a construct that occurs as the result of one's struggle with a highly challenging, stressful, and traumatic event. After students got through emotional crisis, they developed better understanding in life. They obtain growth psychologically and cognitively.

In conclusion, psychological helpers should help students establish social support network. Psychologists should also provide those undergoing the crisis by assisting them to create their own coping resources, and strategies in supporting those under this condition.

## Reference

- Abdulghani, HM 2008, "Stress and depression among medical students: a cross-sectional study at a medical college in Saudi Arabia", *Pakistan Journal of Medical Sciences*, vol. 24, pp. 12-17.
- Benton, SA, Robertson, JM, Tseng, W, Newton, FB, & Benton, SL 2003, "Changes in counseling center client problems across 13 years", *Professional Psychology: Research and Practice*, vol. 34, pp. 66-72.
- Calhoun, LG & Tedeschi, RG 2006, "The posttraumatic growth inventory: measuring the positive legacy of trauma", *Journal of traumatic stress*, vol. 9, no. 3, pp. 455-471.
- Hyun, JK, Quinn, BC, Madon, T, & Lustig, S 2006, "Graduate student mental health: Needs assessment and utilization of counseling services", *Journal of College Student Development*, vol. 47, no.3, pp. 247-266.
- Lazarus, RS & Folkman, S 1984, *Stress, appraisal, and coping*, Springer, New York.
- Lucas, MS & Berkel, LA 2005, "Counseling needs of students who seek help at a university counseling center: A closer look at gender and multicultural issues", *Journal of College Student Development*, vol. 46, pp. 251-266.
- Ramasoot, W 2004, *Sources of stress in Chulalongkorn University undergraduate students*, unpublished thesis, Bangkok, Chulalongkorn University.
- Sukkapan, P, Tungtanathanit, P, Sararat, L, & Sutusanajinda, J 2006, "Stress and mental health problem of Vetterbary Medicice students of KhonKaen University", *Education nnovative*

*Children's Understanding of First- and Second-Order False Beliefs in One Narrative*

Kumiko Matsumoto

Ochanomizu University, Japan

0267

The Asian Conference on Psychology & the Behavioral Sciences 2013

Official Conference Proceedings 2013

Abstract

The results of false belief tasks show that children acquire second-order false beliefs (B thinks that A thinks X is Y) a few years later than first-order false beliefs (A thinks X is Y) (ex. Hayashi, 2002). Although different tasks are used to investigate these two false beliefs, it was unclear whether the story of the second-order false belief task is difficult or the second-order false belief itself is difficult. Therefore, previous studies have focused on creating simple stories for second-order false belief tasks to equalize their complexity level with that of first-order false belief tasks (ex. Sullivan, Zaitchik, & Tager-Flusberg, 1994). But when making the story simple, they also made the structure of the false belief easier. Accordingly, we created two compound tasks, the “fallen ball task” and the “transferred contents task”, which examine both first- and second-order false beliefs of one protagonist in a simple narrative. The study included 67 children aged four-and-a-half to eight-and-a-half years. In both tasks, no child could answer second-order false belief questions, although six-year-olds were shown to answer them in the simple story of Hayashi’s (2002) task. Thus, we concluded that complexity of the story does not affect children’s theory of mind but the structure of the belief does. Moreover, we found that most children who acquired first-order false belief use it when answering the second-order false belief question. We believe that the compound tasks will lead to a new discussion in future studies on theory of mind.

iafor

The International Academic Forum  
[www.iafor.org](http://www.iafor.org)

## INTRODUCTION

In our daily lives, we often guess or read others' mental states (beliefs, desires, etc.) in various situations, especially when communicating with others. In order to do so, we need to understand first-order beliefs, for example, "A thinks that X is Y." However, this is insufficient for the complex situations we face in everyday life. We also need to understand phrases such as "B thinks that 'A thinks that X is Y,'" which are called second-order beliefs. Studies that seek to identify the age at which children begin to understand first- and second-order beliefs fall into a category called "theory of mind." Studies on theory of mind have been developed in various fields, such as developmental psychology, philosophy. Recently, such studies have focused on more practical aspects, especially within autism and medical science research.

In theory of mind research, "false belief tasks" are often implemented to investigate children's ability to understand first- and second-order beliefs. There are three well-known false belief tasks: the chocolate task (Wimmer & Perner, 1983), the Smarties task (Perner, Leekman & Wimmer, 1987), and the ice cream task (Perner & Wimmer, 1985). All these three tasks have a structure in which "the belief of a protagonist changes from true belief to false belief when the location (content, information) changes in his/her absence; in the first two tasks, the belief of only protagonist A changes, while in the last task, the belief of both protagonists A and B changes unknown to each other (Matsumoto, 2008)". The results of these tasks show that children acquire second-order false beliefs a few years later than first-order false beliefs (Sullivan, Zaitchik, & Tager-Flusberg, 1994; Hayashi, 2002). Although different tasks are used to investigate these two types of false beliefs, it has been posited that this delay is caused by the complex stories used in second-order false belief tasks. Prior to a discussion on this matter, we survey the details of these tasks below.

The most frequently used first-order false belief task is the chocolate task (Wimmer & Perner, 1983). In this task, a character named Maxi puts a piece of chocolate into a blue cupboard and then leaves. While he is away, his mother removes the chocolate from the blue cupboard and places it in a green cupboard. The subject is then asked where the character will look for the chocolate when he returns home. The results of this survey showed that most of the six- to nine-year-old children could answer first-order false belief questions, but most of the four- to five-year-olds could not. As the same results were obtained in the Japanese context (Beppu & Nomura, 2005; Koyasu, Nishigaki, & Hattori, 1998; Hayashi, 2002), we can say with some certainty that children develop the ability to pass the chocolate task at age six.

Another famous first-order false belief task is the Smarties task (Perner, et al., 1987). In the Smarties task, the experimenter shows the child a Smarties box and asks what the participant thinks is inside it (expectation question). Then the experimenter shows that the child's answer, "Smarties," is wrong, and that the box actually contains a pencil. The experimenter puts the pencil back in the box and closes it again. Next, the child is asked what his/her friend will think is in the box when seeing it for the first time (first-order false belief question). The child is also asked what he/she thought was in the box when he/she initially saw it (self-past question).



Since it is difficult to keep asking these questions when children do not answer “Smarties” to the expectation question, Koyasu (1997) devised a location change condition. In this condition, the experimenter shows the child a toy refrigerator and a toy chest, and asks children, “Where is the ice-cream, in the refrigerator or in the chest?” According to his survey, only one out of 118 children answered “the chest,” while 27% of children did not answer “chocolate” or “Smarties” in the Smarties task. Koyasu (1997) then executed the Smarties task and the location change condition with three- to six-year-olds. The result of the first-order false belief question in this task shows that only 54% of six-year olds could answer correctly.

The best-known second-order false belief task is the ice cream task (Perner & Wimmer, 1985). Two children, John and Mary, are in the park with an ice cream man. The ice cream man tells Mary that he will be in the park all day long, so she goes home to get money to buy an ice cream. While she is gone, the man tells John that he will be moving toward the church. On his way to the church, the man happens to see Mary and tells her that he is going to the church. Later, John visits Mary’s house, but her mother tells him that Mary has gone out to buy an ice cream. Now the subject is asked where John thinks Mary went to buy an ice cream. The results of this task show that the acquirement of second-order false beliefs starts after children reach the age of 10: only 50% of nine-year-olds and 67% of 10-year-olds could answer it correctly. Although there were significant differences between nine- and 10-year-olds, Koyasu et al. (1998) also insisted that children acquire second-order false beliefs at age 10.

Owing to the complexity of the story in the ice cream task, Hayashi (2002) and Astington, Pelletier, and Homer (2002) designed a new second-order false belief task based on the chocolate task (Wimmer & Perner, 1983). In the “simplified task” (Hayashi, 2002), for example, a girl puts a piece of chocolate in a cabinet and leaves the room. Her brother takes the chocolate out and puts it in a paper bag. Unbeknownst to her brother, the girl is watching what he is doing from the window. The child is asked, “Where does the boy think the girl will look for the chocolate when she returns home?” The results of this study showed that children between six-and-a-half and seven-and-a-half years old understand second-order false beliefs. Results of the “simplified task” (Hayashi, 2002; Astington et al., 2002) lead us to the conclusion that children actually begin to acquire second-order beliefs at age six.

Is making the story easier the only reason for this four-year advance? Perhaps not: Matsumoto (2008) insists that the second-order false belief used during the simplified task (Hayashi, 2002) has a simpler structure than the ice cream task (Perner & Wimmer, 1985). In the ice cream task (Perner & Wimmer, 1985), the beliefs of both John and Mary change from true to false, unbeknownst to each other, when the ice cream man moves from the park to the church. Yet, in the simplified task (Hayashi, 2002), the girl stays visible to the subjects while the boy in the story is transferring the chocolate. This may be the reason why children’s performance was so good in the simplified task (Hayashi, 2002). To solve this problem, we should create a simple storied task with the same structure as the ice cream task.

Furthermore, in order to probe the idea that children acquire first-order false beliefs before second-order false beliefs, we have to ask both types of questions in an equal situation. Matsumoto (2008) thereby insists on the necessity of using new tasks that can ask both first- and second-order false belief questions at once. We call this task a



“compound task” to distinguish it from other false belief tasks.

Considering the aforementioned information, we created two compound tasks for this study: the fallen ball task based on the chocolate task (Wimmer & Perner, 1983) and the transferred contents task based on the location change condition (Koyasu, 1997). Requirements of the compound task for the current study include that the story must have minimum information, as well as a structure by which “the belief of a protagonist changes from true belief to false belief when the location (content, information) changes in his/her absence (Matsumoto, 2008).” Furthermore, we used three alternatives within each compound task. Although there were only two alternatives—the park (second-order) and church—during the ice cream task (Perner & Wimmer, 1985), we could not determine whether children changed their strategies in order to answer second-order false belief questions before and after understanding others’ first-order false beliefs. We will make this point clear with our compound tasks.

This survey aimed to suggest the process of acquiring the false beliefs by verifying the two hypotheses that even if the story is simple, six-year-olds cannot answer second-order false belief questions correctly and that children’s strategies to answer second-order false belief question changes before and after acquiring first-order false belief.

## METHOD

**Participants.** The study participants were Sixty-seven children and included 20 five-year-olds ( $M = 57$  months,  $SD = 0.29$ ), 22 six-year-olds ( $M = 72$  months,  $SD = 0.32$ ), and 25 seven- to eight-year-olds ( $M = 92$  months,  $SD = 0.63$ ).

**Materials.** The materials used in the fallen ball task were paper puppets named Taro (a boy) and Hanako (a girl), a room with a window, a toy box, a table, a basket, and a ball. The materials used in the transferred contents task were a box of colored pencils, a box of chocolates, a carton of milk, and one colored pencil, which are very common things; it is easy to imagine that a box of colored pencils typically contains a colored pencil. A stuffed elephant and a teddy bear were used as characters.



*Figure 1.* A photograph of the puppet play in the “fallen ball task.”

**Procedure.** An experimenter tested the children individually in a quiet room away from the classroom. Two tasks were executed simultaneously, but alternately, to avoid the influence of the first task on the second. The whole procedure took approximately 10 to 15 minutes. The story and the questions in the task are shown in Appendix A and B. All of the children were asked the same questions in the same order to which

they gave oral answers.

## RESULTS

Two of the five-year-olds who could not answer the memory question in the fallen ball task were excluded from the analysis because an understanding of the story is an essential condition when answering belief questions. Additionally, in the transferred contents task, two of the five-year-olds and one of the six-year-olds who were unable to answer the control questions and two of the seven-to eight-year-olds who were unable to answer the expectation question were excluded. Table 1 and 2 show the percentage of answers to each belief question in the fallen ball and transferred contents tasks by age group. Although we asked Hanako's belief (the fallen ball task) and a self-past question (the transferred contents task), those results are excluded from this paper.

Table 1: *Percentage of Answers to Each Belief Question by Age Group (the fallen ball task)*

Answers	Ages					
	5 (N=16)		6 (N=21)		7-8 (N=23)	
	Correct	Incorrect	Correct	Incorrect	Correct	Incorrect
<b>First-order false belief</b>						
Toy box (dummy)	-	44	-	43	-	26
Table (first order)	31	-	43	-	70	-
Wastebasket (current place)	-	19	-	14	-	4
"I don't know"	-	6	-	0	-	0
<b>Second-order false belief</b>						
Toy box (second order)	13	-	24	-	26	-
Table (first order)	-	13	-	29	-	52
Wastebasket (current place)	-	50	-	24	-	13
"He thinks"/"He doesn't think"	-	24	-	18	-	0
"I don't know"	-	0	-	5	-	9

Table 2: *Percentage of Answers to Each Belief Question by Age Group (the transferred contents task)*

Answers	Ages					
	5 (N=16)		6 (N=21)		7-8 (N=23)	
	Correct	Incorrect	Correct	Incorrect	Correct	Incorrect
<b>First-order false belief</b>						
Colored pencil box (first order)	25	-	52	-	70	-
Carton of milk (current place)	-	63	-	38	-	17
Chocolate box (dummy)	-	6	-	10	-	13
"I don't know"	-	6	-	0	-	0
<b>Second-order false belief</b>						
Colored pencil box (second order)	6	-	10	-	17	-
Carton of milk (first order)	-	25	-	42	-	57
Chocolate box (current place)	-	56	-	38	-	22
"He knows"/"He doesn't know"	-	13	-	10	-	4

**First-order belief.** In both tasks, seventy percent of the seven- to eight-year-old children could answer the first-order false belief question correctly (the fallen ball task:  $\chi^2(2) = 6.20$ ,  $p < .05$ , the transferred contents task:  $\chi^2(2) = 7.51$ ,  $p < .05$ ). There were significant differences between the five-year-olds and the seven- to eight-year-olds (the fallen ball task:  $p < .05$ , the transferred contents task:  $p < .10$ ).

**Second-order false belief.** None of the age groups in this survey could correctly answer the second-order false belief question in both tasks (maximum twenty-six and seventeen percent in the fallen ball and transferred contents tasks, respectively).

**Wrong answers of second-order false belief.** In the fallen ball task, fifty percent of the five-year-olds answered the current place but fifty-two percent of the seven- to eight-year-olds answered the first-order. In the transferred contents task, fifty-six percent of five-year-olds answered the current place and fifty-seven percent of age seven- to eight-year-olds answered the first-order.

The logo for 'iafor' is centered on the page. It consists of the lowercase letters 'iafor' in a light blue, serif font. The text is enclosed within a large, stylized circular graphic composed of two overlapping, thick, brush-stroke-like arcs. The upper arc is light blue and the lower arc is light red, creating a circular frame around the text.

## DISCUSSION

The results show that seven- to eight-year-old children understand first-order false beliefs but do not understand second-order false beliefs. Thus, although the story was simple, even seven- to eight-year-olds could not answer the second-order false belief question, probably because the delay in acquiring second-order false beliefs was caused by the structure of the belief itself.

Furthermore, in this survey, the acquirement of the first-order false beliefs was delayed one year compared to the chocolate task (Wimmer & Perner, 1983). What has caused this delay? In these tasks, the information children have to remember includes the location of the object and the characters that moved the object. In the chocolate task, there are three pieces of information (blue cupboard, green cupboard, and mother). In the fallen ball task, children have to choose appropriate locations and characters from six pieces of information (toy box, table, basket, Taro, Hanako, the wind). According to Piaget's developmental stages, seven- to eight-year-olds, who could answer first-order false belief questions in the fallen ball task, are at the beginning of the concrete period. In this period, children start to arrange, classify, and commit information logically (Kojima & Morishita, 2004). This theory explains why six-year-olds can pass the chocolate task but fail the fallen ball task. Thus, the fallen ball task seems to have too much information as a first-order false belief question when compared to the chocolate task.

In case of the transferred contents task, we can ask first-order false belief questions in the first half of the task, before the quantity of information increases. In the transferred contents task, there are only four pieces of information (pencil box, carton of milk, chocolate box, bear) in the first-order false belief section. Therefore, as a first-order false belief task, the difficulty is expected to be reduced than the fallen ball task. The percentage of six-year-olds who correctly answered the first-order false belief question (52%) was the same as in Koyasu's (1997) location change condition (54%), while the results of the chocolate task indicate that six-year-olds can, in fact, understand first-order false beliefs (Beppu & Nomura, 2005; Koyasu et al., 1998; Hayashi, 2002). From this point of view, the difficulty of the transferred task is the same as that of location change condition, but they must both be more difficult than the chocolate task. This is because in the former two tasks, the correct answer is "pencil box (ice-cream)," but the children never see the pencil in the pencil box (ice cream in the refrigerator) during the task, while they do watch the characters put the chocolate into the cupboard in the latter task. The invisible information possibly makes the task difficult for children younger than seven to eight years of age, the age when the concrete period begins.

Furthermore, incorrect answers on second-order false belief questions clarified that after children acquired the first-order false belief, they adopted it when guessing the second-order false belief. This result indicates that children take three steps before understanding the second-order false belief: 1) answer the current place, 2) answer the first-order false belief, and 3) answer the second-order false belief.

## CONCLUSION

In the previous studies, as the story of the "ice cream task" is too complex, the tasks

with simple stories were created (Sullivan et al., 1994; Hayashi, 2002; Astington et al., 2002). The result of our survey shows that the structure of the belief, not the complexity of the story, affects the children's theory of mind. We need to reconsider the result of the "ice cream task," whose credibility has been doubted because of the complex story. However, the story of false belief tasks ought to be simple rather than complex, because the complexity of the story will be obstructive for children before the concrete period.

In addition, the three alternatives led us to the new finding that most children who acquire comprehension of first-order false beliefs use them to answer questions that engage second-order false beliefs. Future studies on how children start to understand the first- and second-order false beliefs will greatly help in assessing or training communication skills of children with developmental disorders.

Future research needs to demonstrate these tasks among samples of children with developmental disorders to see how these children develop the ability to understand second-order false beliefs. We believe that the compound tasks will lead to new discussion in future studies of theory of mind.

## REFERENCES

Astington, J. W., Pelletier, J., & Homer, B. (2002). Theory of mind and epistemological development: The relation between children's second-order false-belief understanding and their ability to reason about evidence. *New Ideas in Psychology, 20*, 131-144.

Beppu, S., & Nomura, K. (2005). Koukinou Jiheisyoudji ha kenjyouji to kotonaru "kokoro no riron" wo motsunoka [Do Children with High Functional Autism Have a Different Theory of Mind than Normal Children?]. *The Japanese Journal of Developmental Psychology, 16*(3), 257-264.

Hayashi, H. (2002). Jidouki niokeru saikitekina shinteki jyoutaino rikai [Children's understanding of recursive mental states]. *Japanese Journal of Educational Psychology, 50*, 43-53.

Kojima, H., & Morishita, M. (2004). *Jidou Shinrigaku he no Shoutai "Kaiteiban" – Shin shinrigaku library=3 [Invitation to child psychology "revised edition" – New Psychology Library, 3]*. Tokyo; Saiensu-sha Co., Ltd. Publishers.

Koyasu, M. (1997). Youji no "Kokoro no Riron" no hattatsu – Kokoro no Hyousyou to Shashin no hyousyou no hikaku [The development of "theory of mind" in young children – A comparison between mental representation and photographic representation]. *Japanese Psychological Review, 40*, 97-109.

Koyasu, M., Nishigaki, J., & Hattori, K. (1998). Ehon keishiki niyoru jidouki no "kokoro no rikai" no chousa [A survey on children's understanding of mind by picture book form]. *Kyoto University Research Studies in Education, 44*, 1-23.

Matsumoto, K. (2008). Ichijiteki Shinnen kadai, Nijiteki Shinnenn kadai nitsuiteno kousatsu: Goshinnennkadai no kouzou bunseki wo chuushinn ni [The examination of 1<sup>st</sup> and 2<sup>nd</sup> order tasks: Focusing on the structure analysis of false belief tasks]. *The*

*Bulletin of the Graduate School of Education of Waseda University, 16(2), 13-23.*

Perner, J., Leekman, S., & Wimmer, H. (1987). Three year-olds' difficulty with false belief: The case for a conceptual deficit. *British Journal of Developmental Psychology, 5*, 125-137.

Perner, J., & Wimmer, H. (1985). "John thinks that Mary thinks that...": Attribution of second order beliefs by 5- to 10-year-old children. *Journal of Experimental Child Psychology, 39*, 437-471.

Sullivan, K., Zaitchik, D., & Tager-Flusberg, H. (1994). Preschoolers can attribute second-order beliefs. *Developmental Psychology, 30*, 395-402.

Wimmer, H., & Perner, J. (1983). Beliefs about beliefs: Representation and constraining function of wrong beliefs in young children's understanding of deception. *Cognition, 13*, 103-128.

The logo for 'iafor' is centered on the page. It consists of the lowercase letters 'iafor' in a light blue, sans-serif font. The logo is partially enclosed by two large, overlapping circular brushstrokes: a light blue one in the foreground and a light red one behind it.



## Appendix A. The Story of the Fallen Ball Task

---

This is Taro's (a boy) and Hanako's (a girl) room. There are three things in the room: a toy box, a table, and a wastebasket.

Taro and Hanako are playing with a ball together. But Hanako decides to go outside to play with her friends, so they put the ball away. Taro and Hanako put the ball in the toy box. Hanako leaves. "See you later!" she says.

Taro is playing alone in the room. He takes the ball out of the toy box and plays with it again. But Taro decides to play outside, too. Taro puts the ball on the table and leaves the room.

Now Hanako comes back in the room. "I'm back!" she says. Hanako finds the ball on the table, so she starts to play with it. But Hanako is hungry. She wants to eat snacks. Hanako puts the ball on the table and leaves the room.

With no one in the room, the wind blows in from the window and pushes the ball into the wastebasket.

*Memory Question 1:*

Where did Taro and Hanako put the ball at first?

*Memory Question 2:*

Where did Taro put the ball when he went out?

*Memory Question 3:*

Where did Hanako put the ball when she left the room to eat snacks?

*Memory Question 4:*

Finally, where did the ball fall?

*First-Order False Belief Question 1:*

Where does Taro think the ball is?

*Control Question:*

Where is the ball now?

*First-Order False Belief Question 2:*

Where does Hanako think the ball is?

*Second-Order False Belief Question:*

Where does Taro think Hanako thinks the ball is?

---

## Appendix B: The Transferred Contents Task

---

There are three boxes in front of us: a box of colored pencils, a box of chocolates, and a box of milk.

*Self-Belief Question:*

In which box do you think a colored pencil is?

Here comes an elephant. Let's open the boxes with the elephant. (The experimenter opens the objects one after another.) Look! A colored pencil is in the box of milk! (The experimenter puts the colored pencil back into the box of milk and closes all boxes.) The elephant is now going home, good-bye! (The elephant leaves.) Now the bear comes. He is a friend of the elephant.

*First-Order False Belief Question:*

In which box does the bear, who hasn't seen inside the boxes, think the colored pencil is?

*Control Question:*

Where is the colored pencil now?

Let's open the boxes and show the bear where the colored pencil is. (The experimenter opens the boxes one after another again.) Now the bear knows that the colored pencil is in the box of milk. The bear is now going home, good-bye! (The bear leaves.) Oh! The box of milk is a little wet. I think it's better to move the colored pencil. I will put it in the box of chocolate.

*Second-Order False Belief Question:*

When both the elephant and the bear come back, where does the bear think the elephant thinks the colored pencil is?

*Control Question:*

Where is the colored pencil now?

*Self-Past Question:*

When you first saw the objects, in which box did you think the colored pencil was?

---

*Living Arrangements and Adjustment of Elderly Persons*

Nisha Dilip Mundada\*<sup>1</sup>, Revati Hatkanagalekar\*<sup>2</sup>

\*<sup>1</sup>SSMM Arts Commerce & Science College, India, \*<sup>2</sup>KWC Arts Commerce & Science College, India

0268

The Asian Conference on Psychology & the Behavioral Sciences 2013

Official Conference Proceedings 2013

Abstract

300 elderly people (between 60 to 70 yrs. both male and female) from Maharashtra state of India were given Shamshad Hussain and Jasbir Kaur's Old Age Adjustment Inventory & Dr. Pramod Kumar's Mental Health Checklist. There is a slight difference in health, home, social, marital, emotional and financial adjustment of elderly persons living in their own homes and living in old age homes. The old age persons living in their own homes are connected to their family and those who are living in old age homes are alienated from their family.

Key words – Old age, living arrangements, Adjustment & mental health

## 1.0 INTRODUCTION

All over the world populations are ageing. The proportion of the world's population aged 60 years or above is increased. Of course there is a variation all over the world. The number of the oldest old i.e. above 80 years is projected to increase. The proportion of people aged 60 years or above is higher in the more developed countries than in less developed regions. Over 60 population rate is increasing at the rate of 2.5 percent per year. Over 80 population rate is increasing at the rate of 4 percent per year. This demographic earthquake "age quake" is tremendous. Due to this the social & economic contexts are also changing & therefore there is a big gap between the generations. Younger & older live together but now the living arrangement of older persons is changing. Therefore this study intends to collect the information of living arrangement of older persons & their adjustments.

Medical inventions over last 2-3 decades & advanced technology have increased overall life span of mankind all over the world. As, a result human being are having good physical & mental health after retirement too, but in most of the cases this is not supported by financial stability & people have to depend on children after retirement. Further they need to adjust with children & there is drastic change in living arrangement. In some cases children do not accept them or they are unable to cope with new lifestyle & are compelled to stay in old age homes.

In India we have strong bonding amongst family members & children take care of parents after retirement. However due to factors such as urbanization, higher cost of living, stress due to competition, high expectations, change in moral values etc. retired people find it difficult to adjust with their children. Old age people's resistance to change, reluctance to accept new ideas etc. create problems in the family. On one side we speak about advanced/new modes of communications bringing the world nearer, but old people do not find anybody in the family with whom they can communicate. As such they feel lonely & are mentally apart though physically near.

Considering above this study is undertaken to analyze the effects of different living arrangements on mental health of old age people.

### 1.1 OLD AGE

In most gerontological literature, people above 60 years of age are considered as 'old' and as constituting the 'elderly' segment of the population. In the traditional Indian culture, Manu, the ancient law giver, in his Dharmashastra divided this span of life into four 'ashramas' or life stages. The first, 'brahmacharya' was to be spent at the teacher's (guru) house. This is the life of student, to be spent in education and training. Once education was complete, the boy would be ready to enter the 'grihastha' ashram. This was the life of a householder. This was the stage when a man would fulfill his basic desires, for love, marriage, for parenthood, for status, wealth, prestige and other such physical and social needs. When a man's head turned grey and wrinkles appeared, he was to give up this life of householder and turn to 'vanaprastha' which literally means 'moving to the forest'. A mature and ageing man would gradually give up his household duties & turn inward in search of spiritual growth. Finally, when he was spiritually ready, he would renounce the world completely and enter the stage of 'sanyasa' or asceticism.

In Indian culture, it was assumed that a wife would follow her husband faithfully in his movement through different stages. Like many other Asian cultures, Indian culture emphasized that the duty of a son to respect and care for his parents. Parents were to be honored as gods. In modern India, retirement age is fixed at 58 in most Government jobs, and 60 years in the Universities. There is a move to increase the retirement age by another two to five years. Chronological age of 58 or 60 is considered as the beginning of old age. Geriatrics is the branch of medicine that focuses on health promotion and the prevention and treatment of disease and disability in later life. The term itself can be distinguished from gerontology, which is the study of the ageing process itself.

## 1.2 LIVING ARRANGEMENT

Living arrangements refers to whether or not the person lives with another person or persons and, if so, whether or not he or she is related to that person or persons. This is a derived variable. It is derived from the responses to questions about the relationships among the people who live in the household.

### I. Living with relatives

This class includes persons who are not in a census family and who live in households where at least one of the other members of the household is related to them. Non-relatives may also be present in the household.

### II. Living with non-relatives

This class includes persons who live in households with other people, none of whom is related to them either by blood, marriage, common-law or adoption.

### III. Living alone

This class includes persons who live alone.

### IV. Living in old homes.

This class includes persons who live in such institutions where no one is related to them.

In India there is strong cultural pressure to 'look after' the parents in the family. Old age home is neither a popular or feasible option. It is desirable to strengthen this 'families'. People live in their later years will make a significant difference to the quality of their living. Availability of caretakers in case of illness, disability, emergencies, depends on living arrangements. Living with a married daughter's family is a less preferred alternative. The 1986/87 National Sample Survey (NSS) reported that 8 per cent of urban and 5.9 per cent of rural elderly lived alone. Living alone is usually due to widowhood, childlessness or migration of children. Following table gives the figures regarding living arrangements of the older people in India based on the NSS report.

**Table-I**  
**Living arrangements of the elderly in India (%)**

	Rural		Urban	
	Male	Female	Male	Female
<b>Institutions</b>	0.65	0.74	0.54	0.20
<b>Alone</b>	11.78	0.69	8.98	0.60
<b>With family</b>	87.19	98.42	90.08	98.77
<b>Non-relatives</b>	0.33	0.16	0.40	0.43

**Graph-I**  
**Living arrangements of the elderly in India (%)**

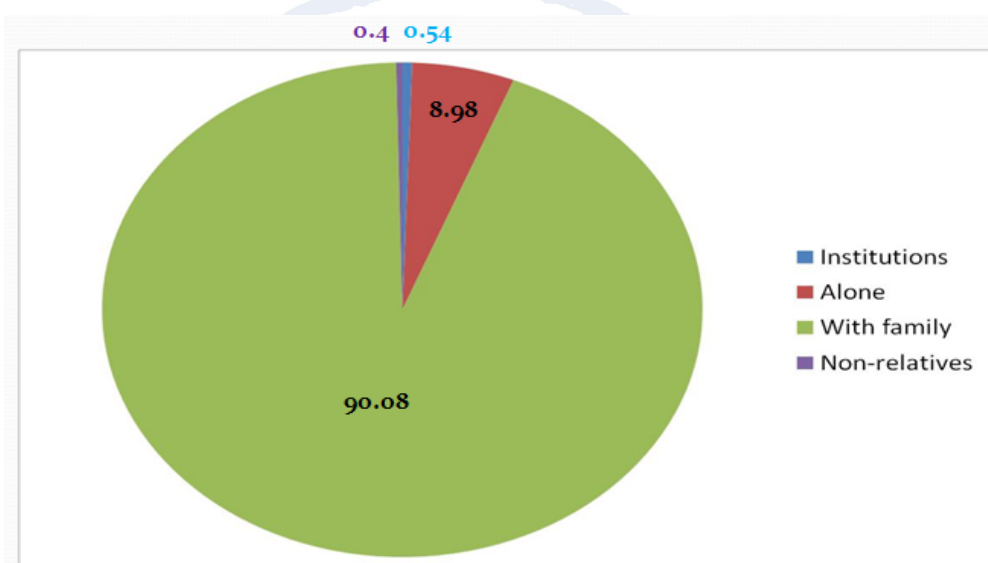

There are 728 Old Age Homes in India today.

Two types of Old Age Homes in India; one is the 'free' type which cares for the destitute old people who have no one else to care for them. They are given shelter, food, clothing & medical care. The second type is the 'Paid' home where care is provided by charging fee. Now a day such 'retirement' homes have become very popular in India & they are well worth considering.

No doubt the best place of elders is their own home

### 1.3 ADJUSTMENT

**Adjustment**, in psychology, the behavioral process by which humans maintain equilibrium among their various needs or between their needs and the obstacles of their environments. A sequence of adjustment begins when a need is felt and ends when it is satisfied. Hungry people, for example, are stimulated by their physiological state to seek food. When they eat, they reduce the stimulating condition that impelled them to activity, and they are thereby adjusted to this particular need.



In general, the adjustment process involves four parts: (1) a need or motive in the form of a strong persistent stimulus, (2) the thwarting or no fulfillment of this need, (3) varied activity, or exploratory behaviour accompanied by problem solving, and (4) some response that removes or at least reduces the initiating stimulus and completes the adjustment.

Social and cultural adjustments are similar to physiological adjustments. People strive to be comfortable in their surroundings and to have their psychological needs (such as love or affirmation) met through the social networks they inhabit. When needs arise, especially in new or changed surroundings, they impel interpersonal activity meant to satisfy those needs. In this way, people increase their familiarity and comfort with their environments, and they come to expect that their needs will be met in the future through their social networks. Ongoing difficulties in social and cultural adjustment may be accompanied by anxiety or depression. Elderly persons have many obstacles regarding their health, home, social, marital, emotional & financial areas. They want to maintain equilibrium among these areas.

#### **1.4 MENTAL HEALTH**

Mental health is an index which shows the extent to which the person has been able to meet his environmental demands-social, emotional or physical. However, when he finds himself trapped in a situation where he does not have matching coping strategies to deal with it effectively, he gets himself mentally strained. This mental strain is generally reflected in symptoms like anxiety, tension, restlessness or hopelessness among others. If it is felt for too long and too extensively by the person, these symptoms may take a definite form (or get 'syndromized'), representing a given illness. Mental health, therefore, should not be confused with mental illness; it is a study of pre-illness mental condition of the person (Kumar, 1991).

Mental health, as such, represents a psychic condition which is characterized by mental peace, harmony and content. It is identified by the absence of disabling and debilitating symptoms, both mental and somatic in the person (Schneiders, 1964).

In India, mental health of older persons is influenced not just by ageing changes in the body and brain, but by socio-economic and psychological factors. Problems related to health and economic conditions lead to suicides in older people. In India, socio-cultural and religious beliefs act as deterrents to suicidal behaviour.

## 2.0 Background

This system provides conceptual background & discusses some empirical studies. What are the main features of living arrangements of older persons in different parts of the world? The globalization economic & social development produces major changes in living arrangements of older persons. These changes affect the well-being of the older population.

Co-residence of older and younger family members has been viewed as an aspect of a “lifetime reciprocity” arrangement in which children traditionally helped their aged parents in exchange for parental support at various stages in the children’s lives (Cowgill, 1986; Cowgill and Holmes, 1972; see also Albert and Cattell, 1994; Lesthaeghe, 1983). Cultural traditions and expectations that adult children should remain with and support aged parents have been reported to exist in a wide range of societies in all world regions.

Among the developed countries of the west, historical changes in living arrangements have been most thoroughly documented by Ruggles for the United States of America. He shows that, in 1850, 70 percent elderly persons were living with a child or child-in-law. Those who did not live with a child, an estimated 30 percent had a child living next door, and most of the rest-about one fifth of the total-did not have any children, either because they never had any, or because their children had died (Ruggles, 2001). The percentage living with children declined in the nineteenth century, but began to decline rapidly after 1920, and especially between 1940 and 1980. Older persons also became less likely to live with relatives other than children, or with non-relatives. Living alone or as a couple became the dominant living arrangement. Living in an institution, such as a nursing home or old-age home, also became more common as time passed.

In some countries in Asia, like Japan showing the change in their attitude. In 1963, when Japanese married women of childbearing age had been questioned about their attitudes towards caring for aged parents, about 80 percent thought that it was either “a good custom” or “a natural duty”; by 1992, only 49 percent thought so. When the women were asked whether they expected to depend on children for support during old age, about two thirds of those questioned in 1950 had expected to rely on children, but by 1992, only 16 percent did (Ogawa, 1994). The proportion supporting the idea that older persons should be able to rely on family for income also declined in Thailand, although about 60 percent thought that the generations should live together both in 1981 and in 1995, there was a decrease in the proportion thinking that the older generation should not expect to rely on children for financial support. At the same time, a large difference in attitudes remains between older persons in these relatively economically advanced Asian countries and those in the United States of America. However, although many older persons maintain daily contact with children living separately, many others do not. Within Europe, the countries where the highest percentages of older persons live separately are also the countries where older persons are least likely to have frequent contact with children and other relatives. Thus, at least in Europe, “intimacy at a distance” does not compensate for higher levels of living alone. To the contrary, lower levels of parent-child co-residence are an aspect of a broader pattern of less-frequent contact with kin.

The evidence available also suggests that older persons in more developed countries today are likely to be in better health than those of similar age in the past or in less developed countries (Fogel, 1993, 2004; Waidmann and Manton, 2000; Palloni, 2001), and are therefore better able to maintain an independent lifestyle. These considerations suggest that living alone may more often be associated with disadvantage in the developing countries than in the more advanced economies. A comparative study in Asia found that in the Philippines, older persons with higher incomes or more education were more likely to live with children, while the opposite pattern was seen in Thailand, Singapore and Taiwan Province of China (Knodel and Ofstedal, 2002). Studies examining socio-economic variables other than income, such as education and rural/urban residence, have also found varying directions of relationships between those factors and living arrangements (Martin and Kinsella, 1994; Bongaarts and Zimmer, 2001).

In America, Europe, earlier research has found evidence of a trend towards separate residence of older persons but now the same finding suggest that there is a global trend towards independent forms of living arrangement among older persons – alone or with spouse only and a corresponding decline in residential arrangement.

Living arrangements of older persons is very simple in India. Living with a child or grandchild is the most common type of living arrangement among older persons in India. The older persons are not interested to live alone. The circumstances force to live them alone sometimes.

India's elderly population has already crossed 100 million marks during 2011. As per analysts of census data and projections elderly population sex ratio is in favor of female elderly. As per the census 2011, where as for total Indian population sex ratio is in favor of male population in ratio 940-1000, for elderly at (60+) population it's in favor of elderly women by 1022-1000.

National surveys have indicated that nearly 5 percent of the senior citizens in the country have no one to look after them as they either do not have children or are neglected by them. Only 32 percent of the senior citizens get pensions, while 38 percent of this age group do not stay with their children.

The fading joint family system in India and other innumerable factors have given rise to west inspired phenomenon of old age homes.

Many factors have contributed to the alienation of the elders.

Migration of young couples from the rural areas to cities in search of better employment opportunities to fend for them.

Elders who have been in control of the household for a long time are unwilling to give up the responsibility to their children.

Youngsters on their part are sometimes resentful of the attitude of their parents.

Many youngsters have moved to places far away from their native homes and in the recent past to many countries abroad. So even if they want, they cannot accommodate their parents in their own homes.

### **Problem**

**Different types of living arrangement of elderly persons, their adjustment & mental health was compared in this study.**

## **3.0. Methodology**

### **3.1 Sample**

300 nos. of old age persons (between 60 to 70 yrs. both male and female) from Pachora and Sangali city in Maharashtra state in India participated in this study.

### **3.2 Measures**

#### **i. Shamshad Hussain and Jasbir Kaur's Old Age Adjustment Inventory.**

In this old age adjustment inventory (SJOAI) 125 items are given. Items are given in booklet. Separate answer sheet is also given in which respondent answer in  a box, yes or no or? Put a cross mark on the box on the answer sheet against relative statements number. Test-retest & odd even reliability is around .80 & test has also high validity. Health, home, social, marital, emotional, financial areas are given in this test. The higher score indicates better adjustment. The responses are scored area wise. The sum of scores in different areas provides measure of overall adjustment.

#### **ii. Dr. Pramod Kumar's Mental Health Checklist.**

This is a short check list of Mental health consist of 11 items, 6 mental & 5 somatic presented in a 4 point rating format. The split-half reliability is .83 and test-retest reliability is .81. The face validity and the content validity is also high.

### **3.3 Hypotheses**

- 1) Majority of the elderly persons preferred living with relatives than old age homes.
- 2) Elderly persons living with children have better adjustment & mental health than elderly persons who live in old age homes.
- 3) Female elderly persons have better adjustment & mental health than male elderly persons.

### **1.0 Discussion / Conclusion**

The present study presents the basic data on living arrangements of older persons, their health home, social, marital, emotional & financial adjustment & mental health. These aspects covered the prevalence of solitary living, co-residence with others- with a focus on residence with children and grand children and institutional living. For this study 300 elderly persons are selected. They are randomly selected from four types of living arrangements.

1. Elderly married persons living with their spouse & children.
2. Elderly persons living with their children only.
3. Elderly persons living with their spouse only.
4. Elderly persons living in the Old Age Homes.

### **Elderly persons preferred living with their children**

When collecting the data on old age adjustment scale & mental health check list the researcher interviewed the elderly persons in the old age homes also. They are not happy there. The chances of living in an institution are also substantially greater for unmarried older persons than for those who have a spouse. Respondents told that the spouse is often the main caregiver for older persons who are unable to manage on their own and those who lack a spouse are evidently at greater risk of entering an institution when they need care. In old age homes unmarried older man are actually more than are unmarried women of the same age. In this study also 40 men & 29 women are in Old Age Homes.

Table –II shows the percentage of elderly persons and their types of living arrangement for major states in India. Five types of living arrangements and their percentage are given by National Sample Survey Organization. Alone, with spouse only, with spouse and other member, with children and with other relations and non-relations are types of living arrangement are given there. In this survey also the percentage for every state is high for the living arrangement with spouse and other members. All India percentage is 44.8 for with spouse and other members of living arrangement. The percentage for alone is 5.2, for with spouse 12, for with children 32.1 and with other relations and non-relations 4.4. It means that in India elderly persons preferred living with their spouse & children therefore the first hypothesis that elderly persons preferred living with their children is accepted.

**Table- II :**

**Living arrangement of persons aged 60 years and above in major states in India (%)**

States	Type of living arrangement				
	Alone	With spouse only	With spouse and other members	With children	With other relations and non-relations
Andhra Pradesh	8.5	20.9	32.4	32.4	4.8
Arunachal Pradesh	3.5	3.4	45.3	25.6	1.2
Assam	2.6	3.5	52.5	35.2	1.3
Bihar	3.9	11.7	50.9	39.3	1.6
Chhattisgarh	8.6	11.4	34.8	47.6	5.2
Delhi	3.6	9.1	53.2	30.3	2.8
Goa	3.7	14.9	46.8	23.2	11.4
Gujarat	5.7	13.7	44.2	34.1	2.0
Haryana	1.0	7.3	58.1	30.5	2.5
Himachal Pradesh	3.8	10.2	41.3	36.6	5.6
Jammu & Kashmir	0.5	5.0	57.7	32.4	2.7
Jharkhand	3.7	9.7	48.0	33.8	2.4

Karnataka	5.3	9.2	45.4	34.5	5.0
Kerala	3.0	9.3	45.5	35.6	5.7
Madhya Pradesh	5.5	14.1	43.2	29.3	5.4
Maharashtra	5.7	12.7	47.0	29.4	4.7
Manipur	2.5	3.9	46.3	28.3	3.3
Meghalaya	3.7	9.4	47.6	33.7	0.7
Mizoram	0.8	2.5	50.4	28.4	4.2
Nagaland	0.6	8.4	75.6	13.8	0.0
Orissa	3.3	11.9	49.6	29.8	2.5
Punjab	2.9	9.5	53.9	30.2	2.5
Rajasthan	3.5	9.9	47.1	34.9	4.3
Sikkim	1.5	4.9	47.9	36.7	4.1
Tamil Nadu	10.9	18.9	36.7	26.9	6.6
Tripura	7.5	15.0	41.2	29.7	4.4
Uttaranchal	9.2	11.4	42.0	31.6	1.8
Uttar Pradesh	4.0	10.0	45.3	33.1	4.8
West Bengal	3.4	7.8	44.4	35.6	5.7
A&N Islands	3.3	2.3	52.3	32.2	4.2
Chandigarh	5.7	18.6	45.6	25.0	4.8
Dadra & N. Haveli	1.3	6.4	64.7	27.3	0.3
Daman & Diu	21.3	3.6	31.4	40.3	1.9
Lakshadweep	3.4	5.5	33.8	45.4	12.0
Pondicherry	6.0	15.0	35.0	41.3	2.7
<b>All India</b>	<b>5.2</b>	<b>12.0</b>	<b>44.8</b>	<b>32.1</b>	<b>4.4</b>

Source: National Sample Survey Organization, (2004)



**Graph- II:  
 Living arrangement of persons aged 60 years and above in major states in India  
 (%)**

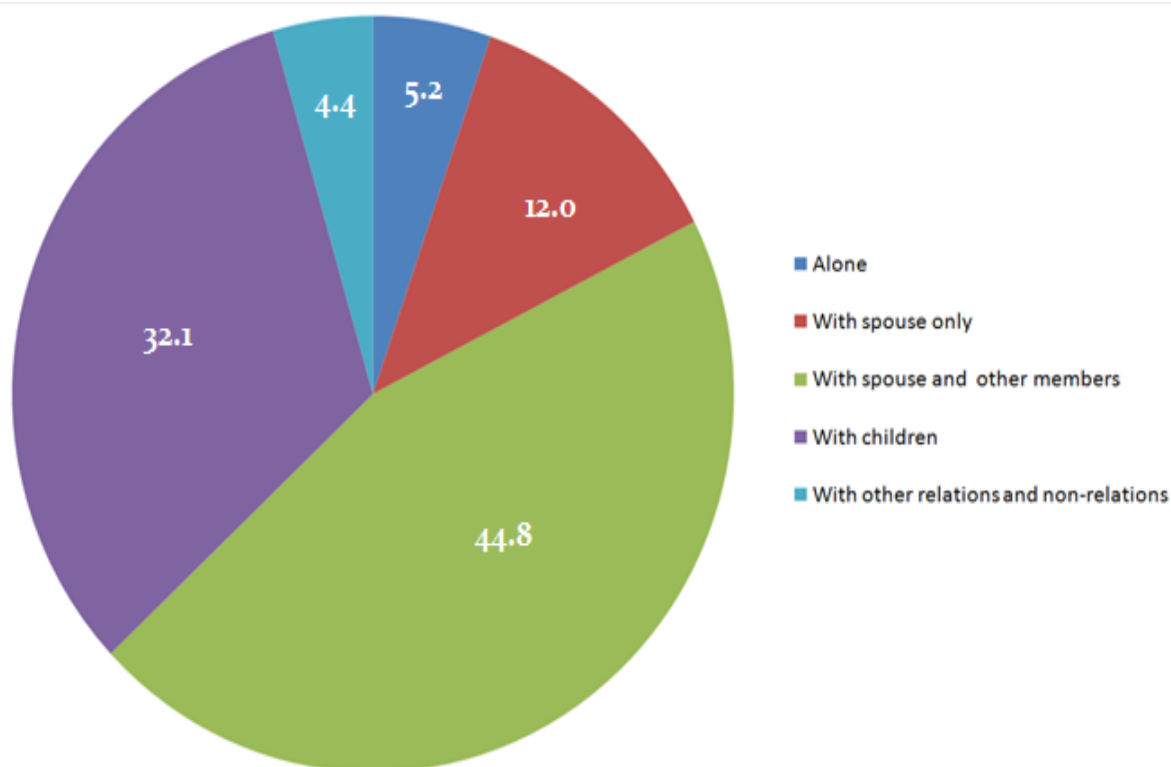

**Living with children has better adjustment & better mental health than living in Old Age Homes**

It is assumed that elderly persons who live with their children are better adjusted in all areas of adjustment. Table I shows the mean standard deviation of four living arrangements on areas of adjustments and mental health. The mean value for the first three living arrangements, which are elderly married persons living with their spouse and children, elderly persons living with their children only, and elderly persons living with their spouse only, is higher than the fourth living arrangement, which is elderly persons living in Old Age Homes. Table I shows the mean value of health, home, social, marital, emotional, financial & overall adjustment for the three living arrangements is higher than the fourth living arrangement. Therefore, the second hypothesis is accepted.

Table III shows the mental health scores for four living arrangements. There is no difference among the four means of living arrangements; it means that mental health problems are the same for all living arrangements. In this test, six mental & five somatic problems are given. In old age, whatever the living arrangement may be, the health problems are everywhere. The mean score is above 22. It indicates very poor mental health. The mean value for elderly persons living in old age homes is above 23. So there is a slight difference among the mean values of four living arrangements. It means that mental health is poorer for those who live in old age homes than those who live with their spouse.

and children. Following table shows mean, standard deviation of areas of adjustment, mental health for different living arrangements.

**TABLE – III**  
**Areas of Adjustment & Mental Health Scores on**  
**Living Arrangement**

Areas of Adjustment	Living Arrangements	No	Mean	Std. Dev	Std. Error Mean	F	Sig
Health	1.00	79	20.4810	34.7496	3.9096	2.171	.143
	2.00	73	16.9041	4.3146	.5050		
	3.00	79	17.5570	4.8826	.5493		
	4.00	69	14.4638	4.5166	.5437		
Home	1.00	79	17.5823	4.9267	.5543	.862	.355
	2.00	73	17.3699	4.3986	.5148		
	3.00	79	17.5570	4.6815	.5267		
	4.00	69	12.0725	5.2055	.6267		
Social	1.00	79	13.5443	4.1163	.4631	2.245	.136
	2.00	73	13.5205	3.6175	.4234		
	3.00	79	13.2405	3.6417	.4097		
	4.00	69	10.9130	3.8107	.4588		
Marital	1.00	79	11.0000	4.7177	.5308	.183	.670
	2.00	73	9.6027	4.8009	.5619		
	3.00	79	8.7975	4.1336	.4651		
	4.00	69	6.4058	3.5741	.4303		
Emotional	1.00	79	13.8101	15.6607	1.7620	2.664	.105
	2.00	73	11.8493	3.8610	.4519		
	3.00	79	12.5570	4.2539	.4786		
	4.00	69	11.3333	4.2380	.5102		
Financial	1.00	79	8.2152	3.2529	.3660	1.778	.184
	2.00	73	8.1918	2.7672	.3239		
	3.00	79	8.6456	2.2305	.2510		
	4.00	69	6.8696	2.7966	.3367		
Overall Adjustment	1.00	79	78.4810	21.7060	2.4421	7.034	.009
	2.00	73	77.3288	16.1847	1.8943		
	3.00	79	77.8228	15.7250	1.7692		
	4.00	69	61.2899	18.5211	2.2297		
Mental Health	1.00	79	22.2785	5.3588	.6029	.001	.981
	2.00	73	22.7123	5.3554	.6268		
	3.00	78	22.4872	5.5543	.6289		
	4.00	69	23.2464	5.1746	.6230		

**Graph – III**  
**Mean Scores of Adjustment & Mental Health on Living Arrangement**

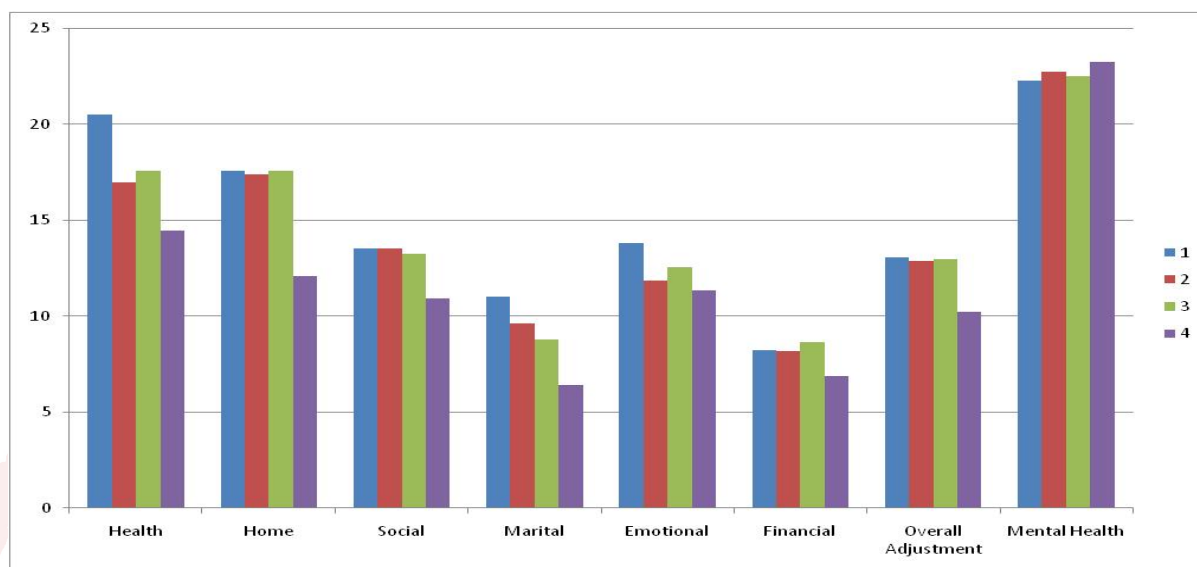

**Living Arrangement**

- 1 Elderly married persons living with their spouse & children.
- 2 Elderly persons living with their children only.
- 3 Elderly persons living with their spouse only.
- 4 Elderly persons living in the Old Age Homes.

**Female elderly persons have better adjustments and better mental health than male**

Following table shows the mean value and standard deviation of different areas of adjustment and mental health of male & female.

**TABLE – IV**  
**Areas of adjustments scores & mental health scores of sex male & female**

Areas of Adjustment	SEX	No	Mean	Std. Deviation	Std. Error Mean	t	Sig
Health	Male	137	16.4745	4.8961	.4183	.852	.395
	Female	163	18.2822	24.4236	1.9130		
Home	Male	137	16.0219	5.3708	.4589	.702	.483
	Female	163	16.4540	5.2543	.4115		
Social	Male	137	12.8686	3.9905	.3409	.062	.951
	Female	163	12.8405	3.8983	.3053		
Marital	Male	137	9.5985	4.5317	.3872	1.983	.048
	Female	163	8.5399	4.6683	.3657		
Emotional	Male	137	13.0803	12.0429	1.0289	1.170	.243
	Female	163	11.8896	4.4901	.3517		

Financial	Male	137	8.1606	2.9512	.2521	.821	.412
	Female	163	7.8896	2.7600	.2162		
Overall Adjustment	Male	137	74.8102	19.7650	1.6886	.601	.548
	Female	163	73.4540	19.1892	1.5030		
Mental Health	Male	137	22.2774	5.1631	.4411	1.144	.254
	Female	162	22.9877	5.5032	.4324		

**Graph – IV**  
**Mean Scores of adjustments & mental health for males & females**

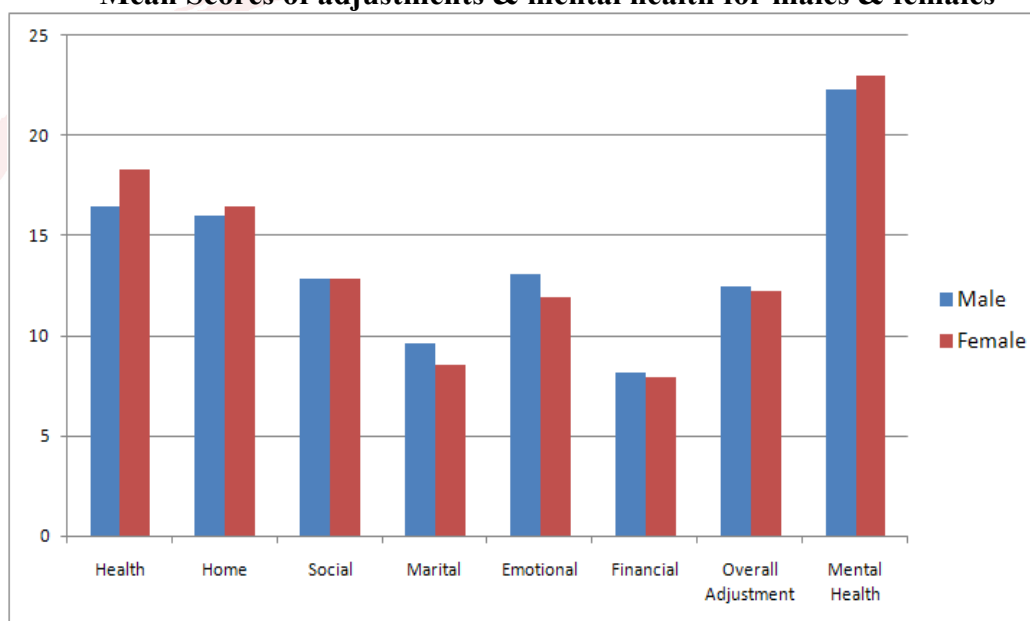

It is assumed that elderly female persons are better adjusted in all areas of adjustment than male. But the mean value for male or female elderly persons on various areas of adjustments scores is not different. The t value is also not significant. Therefore the hypothesis the female elderly persons have better adjustment than male is rejected. It is assumed that female elderly persons have better mental health than male. But the table IV shows mean std. deviation and t value on mental health. The t value is not significant. Therefore the hypothesis that female elderly persons have better mental health than male is rejected.

Information Technology (I.T.) have made modern world smaller & smaller. Person from any Nation can easily contact other person in any corner of the world. People can communicate with each other by way of Internet, Skype, Social Network Sites, Mobile Phones, etc. They need not come physically together for communication.

On one side people are coming nearer due to digital revolution, but as the same time they are not finding enough time to communicate within the family. Gap is being developed within the family members. Due to work pressure neither parents are finding time for children or husband for spouse. The situation becomes grimmer for old age peoples & nobody in family has time for them. Though physically in family, they are mentally miles far away. Most of the times family members being reluctant to accept their old age people, they are compelled stay in old age homes. Taking this into view, this study has been developed to mental health & adjustment of old age people.

## REFERENCES

- Agnihotri, H. K.: Problem of the old age. *Journal of psychological Researches*, 22.01.1976.
- Albert, Steven M., and Maria G. Cattell (1994). *Old Age in Global Perspective*. New York: G. K. Hall and Co.
- Bongaarts, John and Zachary Zimmer (2001). *Living Arrangements of Older Adults in the Developing World: An Analysis of DHS Surveys*. Working Paper, No. 148. New York: Population Council, Policy Research Division.
- Cowgill, Donald O. (1986). *Aging Around the World*. Belmont, California: Wadsworth Publishing Co.
- Fogel, Robert William (1993). Economic growth, population theory and physiology: the bearing of long-term processes on the making of economic policy. Nobel Lecture, 9 December. Available from <http://nobelprize.org/economics/laureates/1993/fogel-lecture.pdf> (accessed 26 November 2004).
- Fogel, Robert William (2004). Changes in the Disparities in Chronic Disease During the Course of the Twentieth Century. NBER Working Paper, 10311. Cambridge, Massachusetts: National Bureau of Economic Research. Available from <http://www.nber.org/papers/w10311> (accessed 26 Nov. 2004).
- Knodel, John, and M. B. Ofstedal (2002). Patterns and determinants of living arrangements (Chapter 5). In *The Well-Being of the Elderly in Asia: A Four-Country Comparative Study*, A. I.
- Kumar, P. Development & standardizations of mental health check list (MHC). *Psychological studies* 1991, 36, 1, 215-217.
- Hermalin, ed. Ann Arbor, Michigan: University of Michigan Press.
- Lesthaeghe, Ron (1983). A century of demographic and cultural in Western Europe: an exploration of underlying dimensions. *Population and Development Review*, vol. 9, pp. 411-435.
- Martin, Linda G. and Kevin Kinsella (1994). Research on the demography of aging in developing countries. In *Demography of Aging*, L.G.
- Martin and S.H. Preston, eds. Washington, D. C.: National Academy Press. pp. 356-403.
- National Sample Survey Organization. Socio economic profile of aged persons. Sarvekshana, 2004.
- Ogawa, Naohiro (1994). Changing attitudes about care of the elderly in postwar Japan. In *The Population and Society of Postwar Japan*, Tokyo: Mainichi Newspapers. pp. 133-165.
- Palloni, Alberto, and M. Peláez. (2002). SABE – Survey on Health and Well-Being of Elders: Preliminary Report. Washington D. C.:
- Pan American Health Organization (PAHO/WHO).
- Ruggles, Steven (1987). *Prolonged Connections: The Rise of the Extended Family in Nineteenth-Century England and America*.

- Madison, Wisconsin: University of Wisconsin Press.
- Ruggles, (2001). Living arrangements and well-being of older persons in the past. Population Bulletin of the United Nations: Living Arrangements of Older Persons. Special Issue, Nos. 42/43 (2001),pp. 111-161. United Nations publication, Sales No. E.01.XIII.16.
- Scheiders, A.A.: Personal Development & Mental Health New York : Holt, 1964.
- Shamsad Hussain-Jasbir Old Age Adjustment Inventory (1995) National Psychological Corporation, Agra, India.
- Waidmann, Timothy A., and Kenneth G. Manton (2000). Measuring trends in disability among the elderly: an international review. Report prepared for the Department of Health and Human Services, task order on "Trends in Disability Rates among the Elderly". Available from [http://cde.duke.edu/publications/DocLib/cds\\_1127\\_wp.pdf](http://cde.duke.edu/publications/DocLib/cds_1127_wp.pdf) (accessed 29 November 2004).

The logo for 'iafor' is centered on the page. It consists of the lowercase letters 'iafor' in a light blue, serif font. The logo is partially enclosed by a large, light blue circular arc that starts from the bottom left and curves around the right side. A smaller, light red circular arc is positioned above the 'iafor' text, partially overlapping the blue arc.



*The Relationships of Trust in Supervisor, On-the-Job Embeddedness, and Intentions to Leave: Testing the Mediating Effect of On-the-Job Embeddedness*

Debora Purba\*<sup>1</sup>, Janneke Oostrom\*<sup>2</sup>, Marise Born\*<sup>1</sup>, Henk van der Molen\*<sup>1</sup>

\*<sup>1</sup>Erasmus University Rotterdam, Netherlands, \*<sup>2</sup>Vrije Universiteit, Netherlands

0270

The Asian Conference on Psychology & the Behavioral Sciences 2013

Official Conference Proceedings 2013

Abstract

Much work has been done on the voluntary turnover topic in over than 50 years, yet much work has to be done to understand the phenomena. Mitchell and Lee (2001) marked the first comprehensive work to try to understand the phenomena of leaving by asking why people stay instead of why people leave. They introduced the term *job embeddedness*, that represents influences from supportive others on an employee's decision to stay in the organization. The present study aimed to investigate the relationships of trust in supervisor, on-the-job embeddedness, and intention to leave. We hypothesize the mediating effect of on-the-job embeddedness in the relationship between trust in supervisor and intention to leave. Data were collected using self-reported, cross-sectional questionnaire among 500 employees in a restaurant chain in Jakarta. The result showed that all dimensions of on-the-job embeddedness correlate either positively and negatively with intentions to leave and trust in supervisor. On-the-job embeddedness also plays an important role as a mediator on the relationship between trust in supervisor and intention to leave. Further results are discussed.

## Introduction

Much work has been done on the voluntary turnover topic in over than 50 years (e.g., March & Simon, 1958; Mitchell & Lee, 2001; Price & Mueller, 1986), yet much work has to be done to understand the phenomena. Mitchell and Lee (2001) marked the first comprehensive work to try to understand the phenomena of leaving by asking why people stay instead of why people leave by introducing *job embeddedness*, that represents influences from supportive others on an employee's decision to stay in the organization. These influences can be work-related (on-the-job embeddedness) as well as non-work-related (off-the-job embeddedness), such as family, friends, community involvement, and job tenure. The two factors of on-the-job embeddedness and off-the-job embeddedness are further divided into three facets of attachment: *fit*, *links*, and *sacrifice*, forming six dimensions of job embeddedness, namely *organization fit* (fit with the organization), *community links* (connection with people in the community), *organization sacrifice* (what one may forfeit if he/she leaves the organization), and *community sacrifice* (what one may forfeit if he/she leaves the community).

Intention to leave precedes actual voluntary turnover, in which actual thought is being given to evaluating the new job alternatives in order to leave the organization or the profession (Allen, Shore, & Griffeth, 2003; Mobley, Griffeth, Hand, & Meglino, 1979). This study focuses on intention to leave as an alternative to understand why people stay and leave.

Among other antecedents of intention to leave, trust in supervisors has been proven as an important antecedent by some researchers (e.g., Mishra and Morrissey, 1990; Tan & Tan, 2000). However, Griffeth, Hom, and Gaertner (2000) in their meta-analysis of antecedents and correlates of employee turnover, found small to moderate effect sizes of leadership (supervisory satisfaction and leader-member exchange) to turnover, and demonstrated that leadership can be presumed as one of the distal causes of turnover (e.g. Hom & Griffeth, 1995; Price & Mueller, 1986). Thus, the purpose in the present study is to offer new theoretical insight on the role job embeddedness as a potential mediating variable between trust in supervisors and intention to leave.

Most of the employees at the company we studied were young people under the age of 26. They were still in the stage of financial need period, making them more likely to view work as a support of life. According to Zhang, Fried, and Griffeth (2012), for such employees, on-the-job embeddedness is more likely to influence turnover than is off-the-job embeddedness. Our hypothesis is that on-the-job embeddedness fully mediates the relationship between trust in supervisor and intention to leave.

## Method

The study is conducted in a well-known restaurant chain with more than ten branches in Jakarta only. Number of participants included in the study is 500. Table 1 shows an overview of the demographic characteristics of the participants. All participants completed the questionnaires on a voluntary basis. The survey was completed during work days within a time period of two weeks. Completion of the self-report questionnaires took approximately 20 minutes. Table 2 shows the means, standard deviations, and intercorrelations of all the study variables.

**Table 1**  
*Demographic Characteristics of Study Participants*

	<i>N</i>	%
Age		
< 26 years	344	68.8
26 – 35 years	147	29.4
36 – 55 years	9	1.8
Gender		
Male	295	59
Female	205	41
Length of work		
< 2 years	288	57.6
2 – 10 years	157	31.4
> 10 years	55	11

*Note.* *N* = 500

The logo for 'iafor' is centered on the page. It consists of the lowercase letters 'iafor' in a light blue, serif font. The logo is partially enclosed by two large, overlapping, brush-stroke-like arcs: a light red one on the left and a light blue one on the right, both curving around the central text.

*Self-Acceptance of Sexual Orientation in Gay Men: A Consensual Qualitative  
Research*

Phakphoom Decha-ananwong, Arunya Tuicomepee, Suppapan Kotrajaras  
Chulalongkorn University, Thailand

0272

The Asian Conference on Psychology & the Behavioral Sciences 2013

Official Conference Proceedings 2013

Abstract

This study aimed to investigate related to experience of self-acceptance of sexual orientation in gay men. Key informants were 10 gay men who had score of points on the self-acceptance of gay men scale as of 4.5 to 5 points. They were selected purposively according to the fixed set of criteria. Data were collected by in-depth interview and analyzed by using consensus qualitative research method. The results reveal six domains: (1) Beginning to sense one's own homosexual orientation, (i.e., sensing of gay vibe, the attraction to heterosexual, and self-denial of the gay sense) (2) Experiences that facilitate adopting gay identity, (i.e., encountering with social prejudice, having a sexual experience and relationship with men, and the acceptance of same-sex attracted feeling) (3) Sexual identity acceptance, (i.e., the acceptance of gay identity, the attitudes toward society with self-acceptance, and entering to gay society) (4) Disclosure of the gay identity, (i.e., self-disclosure to family and self-disclosure to society) (5) Perceiving difficulties of living a gay life and to live harmoniously with oneself and with others, (i.e., Perceiving difficulties of living a gay life, and to live harmoniously with oneself and with others and) (6) Integrating gay identity to self identity and emerging a coherent and integrated self, (i.e., Integrating gay identity to self identity, and emerging a coherent and integrated self).

**Keywords:** self-acceptance, gay men, sexual orientation

## Introduction

Self-acceptance is the self-consciousness of oneself by individual through the process of understanding their own life with reasonable reality, perceiving the pros and cons, and accepting the limitations and errors of their own judgment. This also includes understanding the environmental contexts and situations involved in determining one's own idea with the responsibility of their decision that will result in the ability to live life with efficiency and using the full potential of their own capabilities. Moreover, this acceptance leads to the feeling that they are valuable, as well as building relationships with others effectively and creatively (Hamachek, 1992; David, 1997; Rogers, 1974). Previous research found that for lesbians, gay and bisexuals, "the acceptance and disclosure of their identity" is significant in developing, and or increasing personal self-worth, as individuals experience difficulties in the duration of life (Bohan, 1996) - particularly for gay men. Many researchers have determined that the disclosure of one's sexual orientation to their parents and the intimate is extremely important to the well-being of the gay men (Bangon Taptien, 2008; Bohan, 1996; de Monteflores, 1993; Dew et al., 2005; Gonsiorek, 1995) and self-disclosure is also crucial to the healthy development of gender identity in gay men (Cass, 1996).

In contemporary Thailand, sexual segregation is rampant; gay men grow up as a subgroup of society at large which can be seen from the social stigma attached to the sexual orientation. According to Jackson's (1999) study, the image of gay men in the context of Thailand's public media in a domestic altercation and or death, always degrades men who have sex with men (MSM) as being murdered because of jealousy. Moreover, the media depicts gay men as a carrier of AIDS. These negative stereotypes serve to make a male feel embarrassed of his sexual preference and identity. Jackson also revealed that the social perception of gay men in Thailand is only "tolerance but not accepted" and can be accept only limited expression in Thai society.

The research of Bongkodmad Aekeim (2008) studied the culture of sex and family life of homosexual in Thailand, and the influence on the idea of "Family" that affects the senses. Ideally, homosexuals start from the definition of self. This is reinforced through the growth that has been nurtured in the family, and ideally society's heterosexual population as well as the abolishment of various negative societal biases. Negative deviation concerning the perception of homosexuals causes negative effects in the feelings and psychological conflict within gay men when they are stigmatized as different from others. In some cases, this leads to the formation of negative feelings towards themselves into the spirit of their own being because of society's prejudice against the internalized homonegativity (Kimmel, 2004; Herek, 2004).

Theories regarding homosexual identity on the issue of disclosure have revealed that there is no difference in the experience within this group of people. Predominately, the assertion that experiences do not differ in terms of self-disclosure in the social

context has been strongly opposed (Cass, 1996; McCarn & Fassinger, 1996). Some authors have proposed that individual differences and the environment may affect one's ability and desire of the individual to deal with the challenges in the process of self-disclosure (Cass, 1996).

Different theories have been influenced by the psychoanalytic perspective. One possible explanation of the interpersonal relationships in the previous study of lesbian, gay and bisexual (LGB) may affect the experience of LGB. This includes, the level of self-acceptance and disclosure concerning sexual orientation on their own, naturally. (Cohler & Galatzer - Levy, 1996; Laird, 1996). However, one question never explicitly posed to gay men is: "how different factors affect competence for self-acceptance and disclosure for themselves in different ways". Although many theories explain the variability of factors in groups of gay men, there is no framework to explain about these differences. Also, in Thailand, there are limited numbers of research studies vis-à-vis the psychology in gay men. This paper therefore aimed to focus on the experience of self-acceptance of sexual orientation in gay men in order to provide some insight into void in important contemporary qualitative research.

## **Methodology**

This study employed a consensual qualitative research (CQR) design as detailed below:

**Key Informants.** They were 10 Thai gay men who had score of points on the self-acceptance of gay men scale ranging from 4.5 to 5 points of 5. They were selected purposively according to the criteria: accepted himself as gay man, committed or living within gay world at least 1 year, had score of points on the *Self-acceptance of Gay men Scale* (SAG) as of 4.5 to 5 points of 5, ability to articulate their experience, and willingness to participate in the study and share their information. The key informants participated in the study during September 2012–February, 2013.

**Instruments:** Instruments included *the Self-acceptance of Gay men Scale* (SAG) and interview guideline. The instruments were developed by the researcher and reviewed by 3 experts before application.

**Procedure and Data Analysis.** After receiving the approval from the Committee for Human Research, Chulalongkorn University, the researcher contacted the gatekeepers to recruit the qualified key informants. Then, the appointments with the key informants were made to provide them with information about the study and their rights to participate in the study. Those who were willing to participate in the study were asked to sign the consent form and completed the self-acceptance scale. After the completion of the preliminary forms, the gay men who passed all the criteria on the scale were invited and interviewed once, each for approximately 1-2 hours. After a verbatim transcription of the interview tapes, the data analyzed using CQR method (Hill et al 2005). Trustworthiness of the analysis - validity of the findings,



interpretation, and summary from supportive data were achieved through an external audit conducted by 2 experts on qualitative research, as well as member checking.

## Results

Findings revealed six main themes of the experiences of self-acceptance of sexual orientation in gay men as presented below.

### 1. Beginning to sense one's own homosexual orientation

**1.1 Sensing of gay vibe:** all of key informants (N=10) started to sense their own homosexual feeling since they were young. The feeling was already there and waiting for them to explore and discover it – this was a common sensation shared by the key informants. (i.e. the attraction to a man) They were interested in the same-sex, and were satisfied by those feelings. Some of them started to masturbate to porn, during which, they were focusing on men more than women. During that time, many of them reported that they did not know and understand those feelings since they lacked information on sexual orientation.

*“Because I felt during that time, the word “gay” did not exist, only “queer” and “tootsie”. The word “gay” just came about, and was quite new. I remembered I couldn't even explain “what is gay?” I didn't know for sure, I only knew that I loved my friend, I loved him like a puppy love.” (ID4)*

**1.2 The attraction to heterosexual:** many key informants (N=7) used to have a crush on woman and were interested in women; some even had a relationship with a woman. Two of them had a curiosity that they might be a bisexual and tried to uncover/discover their own true nature.

*“Because I remember when I was a boy, I liked girls as well. I liked (a Thai actress). She was so beautiful, you know? Well, it's not clear, but I knew I was gay (as a child). When I saw a pretty girl I wanted her to be my girlfriend when I was a kid.”(ID3)*

**1.3 Self-denial of the gay sense:** Since some of key informants (N=3) started to be aware of their homosexual feelings which was incongruent with the expectation of family and society, they tended to suppress those feelings in the initial period because of the stigmatization of society

*“Speaking of that time I felt that I liked it, but deep down I went against myself a lot. Yes, it was up against. That It wasn't me. I would not do anything, it deviates from the norm. Because we're afraid of the family's standing (in society). It was not too severe. But it's a feeling of “No, not me ... I felt like it was something that people do not want, it was really embarrassing. I will not be the case. If so, then it is bad. Every teacher I know. My mother was there, something like that.”(ID4)*

## 2. Experiences that facilitate adopting gay identity

**2.1 Encountering social prejudice:** the key informant confronted some negative biases of people in society. As such, they had to learn to adapt themselves to survive.

**2.1.1 Being discriminated from society:** some of key informants (N=5) suffered discrimination and was parody which causes the feeling of being devalued as a human. They felt embarrassed, angry and being looked down upon, diminished their dignity. They think what happened to them is not fair. They felt a sense of alienation from the group. The informants stated that their experiences and their behavior are different from a typical boy which trend toward a girl.

*“Well, I took my parody, I did not really like being called like this ... to have people call you a tootsie, and how can I express it. It’s like you are stranger, something like that. I don’t know if it sounds, like at that time the word “toot”, you know. There wasn’t a word for gay only toot. Nobody would like it if you were called like that.” (ID5)*

**2.1.2 Reaction to negatively social biases:** The key informants (N=3) attempted to protect themselves from the social stigma that comes from all those around society. They attempted to suppress the expression of their identity as gay to prevent being denounced. They felt anxiety and fear of being punished for expressing themselves as gay. They gradually learned to live in that society or learned to deal with the pressure, to be a driving force for their perceived inferiority is accepted, and not be ostracized from their own society.

*“It’s stressful. Cause there’s nothing I could do, you know? It’s a situation that I didn’t know how to solve it, if I could have, I would have fixed it. I don’t mean I have to change my behaviors or my sexual orientation. But what would make it better? I’d have liked to, but I couldn’t. So I tried very hard to study hard to do some activities that I felt would make me have more value. I was able to do this, to lead me for what I am today.”(ID6)*

**2.2 Having a sexual experience and relationship with men:** the key informants that had experienced a sexual and romantic relationship with men emphatically stated that it helps GAY MEN. This became more self-evident the higher experiential level.

**2.1.1 Having a sexual experience with a man:** The key informants (N=6) benefited through sexual experiences with men. They may have sexual feelings for a man involved. As well as having sex with other men, they were satisfied in the feeling that they experienced, which aided in greater self-understanding and clarity. The feelings that occurred during the sexual encounter fulfilled their emotional and mental desires, longings and needs. In some cases, the informants had sexual experiences with both males and females. They will realize that they were happier, and had higher levels of with men more than women.

*“If I speak about my sexual experience, well I had it first time after I graduated. At first I didn’t know how to do it and I didn’t think it possible as well. But he was older than me. He knew what to do so we did it. After that, it supported my feeling that it is right feeling, sort of.” (ID5)*

**2.1.2 Having a romantic relationship with a man:** The informants (N=4) experienced a romantic relationship with a man, which provided clarity and opportunity to a full gay identity.. They were able to understand on an experiential level about how a romantic relationship with a man would feel. Some informants mentioned that having a relationship with the man aided their transition into a “complete” gay man.

*“I’m a complete woman. This would be a good sentence to explain myself. It’s like I’m ready in every single way. From the very first time, I felt like I liked men, then I started to develop my gay identity. My identity is like being overwhelmed. Do I have everything I need? How can I say this? I can feel and I can sense everything even though, in the past, I can only feel this with my mind. But now, I can feel this even more. For example, if I had to have a boyfriend, we can touch each other and we can start to learn from each other too.”(ID8)*

**2.3 The acceptance of same-sex attracted feeling:** Informants (N=9) listen to their inner feelings and desires. They do not refuse or try to change their feeling, but they accept the feeling of loving men as part of them. The acceptance of this feeling is the way they are happy to be with men more than women. Being with women cannot fulfill their needs on the same level compared to being with men.

*“I don’t feel like I should have to change myself to love women. No. I don’t have to do that to satisfy my parents’ needs. Well, it’s about accepting yourself as being gay as I said before. This is very clear and it is still clear that it’s impossible. I don’t feel like I should stop being gay or I should have strong feeling towards women.”(ID2)*

### **3. Sexual identity acceptance**

**3.1 The acceptance of gay identity:** This is how the informants (N=10) discovered and understood their own nature, and learned to accept their gay identity as an integral part of being. They accept their expression through behavior that is different compared to straight men. They see that being gay is not a negative thing, but rather, just sexual preference even though society may see it in an opposing or contrary manner. They do things that make them happy and they have never felt unhappy or having any conflicts with their identity. Moreover, some of the informants also stated the definition of gay for themselves.

*“It’s just like comparing a lotus with a rose. It depends on your preference whether to choose lotus or rose. OK, I choose a rose and I don’t choose a lotus. That’s all” (ID9)*

**3.2 The attitudes toward society with self-acceptance:** This is the way the informants (N=6) hold a positive attitude towards society, realize and accept the fact that there are some people in the society who cannot accept the diversity of sexual preference. This includes how the informants harmonized themselves with society, and how they represent themselves in their own position in society.

*“I cannot change anybody’s attitude or even cannot force them to accept the way I am but I can live in society as being a little part of it and I don’t want to do anything big like saving the world or whatever but at least I don’t make any troubles for anyone. On the other hand, I try to make things better. I believe there are some people who cannot accept my sexual preference but IF they could accept the way I am then it’s just OK.”(ID6)*

**3.3 Entering into to gay society:** This shows how the informants (N=8) gained access to gay society including online society that made them feel like a part of that particular society where they met many people who have the same sexual preference. They have their own way to stand in society and this gay society helped them learn many things such as gay idol, understanding of their own way of living as being gay, learning to improve their appearance to attract other gay men along with opening up opportunities to interact with other gay men. One of the informants stated that being part of gay society made him feel free, feel attachment to the group and feel happy to be in gay society.

*“Then it led me to be in this society even more. Especially when I was in high school, I used Pirch application to chat with other gay men. High School Gay and Bangkok Gay were my favorite chat rooms. I met many people through this application. It also helped me learn how to have sex with other gay men like learning to know what lubricant is and learn how to prepare yourself before having sex”(ID3)*

#### **4. Disclosure of gay identity**

**4.1 self-disclosures to family:** This section refers to experience after the informants got a clarity and acceptance of their own sexual orientation. It is similar to the next challenging stage in developing gay identities. They have to accept themselves and to reveal themselves to the other people, such as non-gay family members. The informant’s decision to reveal themselves or not, depend on many factors.

**4.1.1 Fear and anxiety to reaction of family member:** The informants (N=7) realize that they are not what they family expected. As a result, they feel anxious, disappointed and afraid of rejection and punishment. They are afraid

they will embarrass their family. Those informants know how they will be perceived in their society, and that their parents will be disappointed by their gay children. However, the informants do not really know their family's position and/or opinions towards them. The informants choose not to disclose themselves to their family at their first stage of self-acceptance due to anxiety and lack of readiness.

*"When I came back to the same old environment, I was very certain that I was gay. I started flirting with men but the same limits still existed. I was afraid that my parents and my close friends would know that I was gay. I did not want anyone that knew me to know it especially my parents. I was afraid I would disappoint my parents and that they would be embarrassed of me. I was afraid that that would not be proud of me. That was what mattered to me."* (ID4)

**4.1.2 Perceived attitude of family member toward being gay:** The attitude of the informants' family (N=7) towards them as gay individuals, as well as the gay community has an impact on the informants' decision to disclose themselves.

*"I think my family still cannot accept it. I still have to hide it from my family, especially my father. He really dislikes the gay community. That is why he still does not know (that I am gay)."* (ID5)

**4.1.3 Readiness in coming out to family member:** The informants (N=8) start expressing themselves as gay individuals to their family by directly discussing the subject or giving them hints such as bring their partner home to meet the parents. They feel secure and ready to take care of themselves if they are rejected by their family. They may wait for their family to accept them in other aspects in life before they come out. They do not feel like they are letting their family down and they will try to compensate in other areas. Some informants feel stressed and want relief. They want their family to know their real self and do not want to hide it any longer.

*"Because my parents see me with this guy for a long time, they can tell that my behaviors are not those that belong to just a typical friendship. My parents asked me what was really going on. That gave me the opportunity to discuss the issue with them.. Actually, I had been meaning to discuss this for over ten years but I had never had the opportunity to do so. Back then I did not know how I would turn out. When I was done with college and had a job, I felt like I was ready to be myself. It was time."* (ID5)

**4.2 self-disclosures to society:** Whether or not the informants disclose themselves to society depends on the core values and attitude of that particular society. Moreover, living in a gay accepting community helps homosexuals feel more at ease and not discriminated against. They are more open about their identity.

**4.2.1 The attitude of their living society and the choice of coming out:** The informants (N=6) understand that society is unaccepting of homosexuals and that the attitudes towards gay people still have not evolved over time does not make it



easier for the informants to disclose themselves. However, they may or may not choose to disclose themselves to the public. Some informants feel more comfortable disclosing themselves to a community that has other gay people besides themselves.

*“The new generations especially nowadays are more open and accepting. I had the opportunity to come out and accept myself for who I am, not having to feel guilty and suffer. The new generations express themselves more. They accept themselves for who they are and would like other people to accept them as well. They have more opportunities to communicate and inform other people about their self identities.”(ID6)*

**4.2.2 Living in society that is open in diversity:** Thai society being open and non-resenting of homosexuals and the gay community assists the informants (N=7) to accept and express themselves more, and the more they feel comfortable with man-to-man relationships in public. They do not feel pressured to hide their same sex relationships. Some of the informants stated that they felt very lucky to be part of Thai open-minded society.

*“We can fully be ourselves. That does not mean that just because we were in this society, we will behave indecently like some man-to-man or gay people. We are in a society that accepts us and we are good citizens. We want to contribute to our society and the people around us and not holding them back. So, I think that if we do the right things, we can live our lives to the fullest or something like that. We do not have to put ourselves under pressure. We do not have to hide from the people around us. It makes us more sincere to our friends and family. And they are sincere to us as well.”(ID6)*

**4.2.3 Balancing in coming out:** The informants (N=7) make their decision to come out or not based on the consequences after coming out as well as their comfort level towards certain people such a close friends.

*“If they want to know, I will tell them directly that I have a boyfriend (giggles).I think it would waste my time not to because I am confident with whom I am. I do not create drama or something of that sort. That is “too much” (femininely suggests).”(ID1)*

## **5. Living a gay life**

**5.1 Perceiving difficulties of living a gay life:** The section addresses the way informants (N=7) realize certain difficulties and limitations associated with living a gay life. For example, they cannot have children or cannot have a typical family as men and women can as expected by the society. Moreover, keeping a gay relationship is also a difficult task. They are also worried about the end of their lives along with limited working opportunities given by the prejudice in society. On the contrary, some of the informants stated that they have never been worried about difficulties of living a gay life.

*“If Mai had to have a girlfriend or to have sex with a girl or even to get married and be in a fake relationship with a woman, having my own family, have a child, just to fool myself into thinking that I have my own perfect family.*



*“I cannot do that”. As there are so many people involved; a wife, a child. If one day they happened to know I am gay then what would happen? I am scared of the consequences. So I accept the way I am and I realize that I may have to be alone or to be with a gay partner instead of having my own family.” Being gay takes away many opportunities in one’s life. As I said, at least it takes away the dream of having a perfect family, having children and marriage.” (ID2)*

**5.2 To live harmoniously with oneself and with others:** Informants also develop their own identity in many ways apart from sexual identity in order to live harmoniously with oneself and with others. Significantly, they tend to value their parents as the first priority.

**5.2.1 Having a commitment to self-development:** The way the informants (N=6) are likely to develop themselves in many ways such as education, work, creativity and their individual potential. They believe in their own capabilities even though their own identity may not be relevant to the expectation of society. Still, they can balance their identity along with maintaining various ways of self-development in order to be accepted by their family members and the society.

*“Someone like me, I feel like I have to be on top you know, Top performance, everything. Which way that we are good at, we go that way. I don’t know. It feels like a gift.”(ID2)*

**5.2.2 Focusing of parent and family member:** The informants (N=7) realize that they will not startup their new family, hence, having no children. Accordingly, they tend to focus on taking care of their parents and other family members. On the other hand, they also tend not to create troubles by disappointing the family in order to balance some of gay life’s difficulties such as not being able to have children, not being able to startup new family like heterosexuals, inter alia. They overcome all of these by creating new identity as a “good son” in order to live harmoniously with parents as parents are immensely important to them.

*“Well, I don’t see any chance to have my own family in the future, like having a wife, having my own kids (laughs). So the only one thing I have is my family, dad, mom, and brother. So instead of focusing on a future family, I am focusing on myself, mom, dad, and brother. Those are the people I have to take care of.” (ID2)*

## **6. Emergence of an integrated personality**

**6.1 Integrating gay identity to self-identity:** The informants(N=9) were open to all of the experiences; developing the self in others aspects gradually, to combine gay self with self-structure, which has been the life time process since they were young- the success of which increases self-worth, and reinforces what makes them happy to be themselves. They do not want to be something else beside themselves. They have a fulfilled life.

*“I live my life the way I think I’m happy, but all the relationships I think I have built them up for so long since I was a teen so I can mingle and live with all others no matter they are straights or whatever. I can live with them peacefully. No one has ever bullied me. It might be because I’m a bit quiet but not that quiet but when I’m with my friends I still have fun with them without being in fear if they know that I’m gay. I don’t feel frustrated at all, and there’s no problem.”(ID1)*

**6.2 Emerging a coherent and integrated self:** After the formants (N=9) integrated the gay self with the other self they found the harmony in their complete self. They will be proud of being gay. Having increased self-esteem, and confidence in being gay. They have satisfaction of life. They feel relaxed in their own self.

*“I think I’m happy with the way I choose to live my life as being gay. Now I enjoy living my life and I don’t think being gay is good or bad or whatever just because I’m happy.”(ID5)*

## **Discussion**

The experience of Thai gay men with high self-acceptance of sexual orientation was depicted as a positive one by many interview respondents with the weight of trust in one’s own organism and openness to experience about the sense of self and experiences of sexual orientation as gay men that lead to one identity synthesis and full self-acceptance. According to the findings, self-acceptance is a vital process for those who are homosexual, including gay men. As gay men start to explore their gay identities it might cause incongruence with social values, and in turn, they internalized that dichotomy within themselves. This idea will be elaborated upon in the following section;

First, the discovery of sexual identity; every gay man in this research began to sense some signs within himself at an early age. Those signs are the sensing of a gay vibe since they were young. However, in their childhood, they might have lacked the knowledge and understanding about sexual diversities. Thus, they might not have understood their own feelings; this is consistent with the findings of Savin-Williams (2005) stating that mostly young LGBT begin to be aware of their own sexual orientation since adolescence. So this period of experience is an ignition of a process of self-acceptance, it’s a wakeup call of being gay. The findings are supported by the study of Cass (1979) the first stage; Identity confusion, also the first stage of Troiden (1979); Sensitization. The function of self-acceptance will work continuously if they don’t not ignore those signs but rather they go on an exploration of those feelings..

Moreover, the “Self” theory of Rogers (1951) explains about self-acceptance which begins as they open themselves to experience and perceive them as reality (openness

to experience). According to the informants, some of them used to have an attraction to women, and this attraction is like an alternating current. The occurrence of this phenomenon can be viewed as the beginning of the process of developing identities in the first step of the model bisexual identity of Martin et al (1994) (Initial confusion). In this stage the person begins to be confused about their own sexual orientation. They feel the strong sexual desire for both male and female. In another aspect, the confusion may be a self-defense mechanism that gay men created in order to achieve a sense of harmony with the values of society. The mechanism is "*Self-denial of the gay sense*". Since they internalized the social values to be their own values, the incongruence can lead to interrupt the process of self-acceptance. However, only 3 out of the 10 cases use to deny their inner feelings, which can be explained by Rogers (1951). As all of the emerging feelings are sensory and visceral, the experience can be quite confusing and extremely difficult to suppress.

Some of the informants used to be confronted with negative social biases. Moreover, most of them have a quiet polite personality and their behaviors tend to be effeminate. This is congruent with the results from the study of Sharpe (2002) that those targets of homophobia will be effeminate boys or butch girls. But at the same time "facing with prejudice" is likely to be a test before they will reach to the top of the mountain. Facing stigmatization - though difficult and painful- can result in a person having increased clarity of the understanding that he is homosexual.

One of the vital factors in an effective self-acceptance process is "the acceptance of same-sex attracted feeling" working in 2 dimensions; 1) Making gay men realize that he is satisfied with the attraction to men and 2) the key to drive the process "Openness these attracted to men feeling to be as a part of his experience", consistent with Rogers (1951) "The fully functioning person", composed of 3 factors; openness to experience, organism trusting and Existential living; the combination of these three steps aid in acceptance of ones' self as gay men. They will reach out to other gay community members by entering into gay society. This materialized in some emerging gay men entering gay society via online social network –this is consistent with the study of Hillier and Harrison (2007) that found that young LGB who are not ready to come out will find the LGB information through the internet.

After gay men can answer to themselves "Who am I?" then they can keep it within themselves, or progress to find satisfaction and an answer for the question "Where do I belong?" This is substantiated by the study of Cass (1996). But in the Thai culture context, gay men have to find the answer of "Where do I belong in society, especially in respect to my family?" At first, informants will be worried about the acceptance of the family, and they tend to hide themselves because in Thai society "if your son turns out to be gay, the parent would not be happy." So they are afraid that they might shame their family by being gay, consistent with the findings of Bangon Taptien (2008) the family has a vital effect on Thai gay men. In addition, in line with Rogers (1951), all human beings have a definitive need for positive regard, gay men

included. If gay men know that their parents accept them with conditional positive regard. They will not disclose themselves until they are ready in this sense readiness is in reference to the ability to live on their own, etc (self-reliance). Also they try to develop themselves to live harmoniously with oneself and their families. Eventually, gay men, they will increasingly open all of the experience and then merge gay self and other self to be integrated within a new self-structure for which I purpose the word "Harmosexual"- this denotes a homosexual who has a harmony in self, and life.

## Conclusion

The process of self-acceptance in gay men is a life time process. These findings suggest that trust in one's own organism, openness to experience about the sense of self and experience of sexual orientation as gay men and also existential living leading to one's identity synthesis. As in the Cass's theory (1979) homosexual identity development, gay men are going to develop their homosexual identity from the first stage to the last stage in life. This knowledge has considerable implications for psychological services trying to understand and enhance the well-being of the gay men. However, further investigation on the experience of self-acceptance in gay men should be carried with a cohort study in the future.

## References

- Bangon Taptien (2008). Sexual culture and family life of homosexual. Doctoral of Applied Behavior Science. Srinakharinwirot University.
- Bohan, J. S. (1996). *Psychology and sexual orientation: Coming to terms*. New York: Routledge.
- Bongkodmad Aekeim (2008). Gay! The process of identity development and commitment as homosexual identity. Master of Human and Social science. Thammasat University.
- Cass, V.C. (1979). Homosexual identity formation: A theoretical model. *Journal of homosexuality*, 4(3), 219-35.
- Cass, V.C. (1996). Sexual orientation identity formation: A western phenomenon. In R. P. Cabaj & T. S. Stein (Eds.), *Textbook of homosexuality and mental health* (pp. 227-251). Washington, DC: American Psychiatric Press.
- Cohler, B. J., & Galatzer-Levy, R. (1996). Self psychology and homosexuality: Sexual orientation and maintenance of personal integrity. In R. P. Cabaj & T. S. Stein (Eds.), *Textbook of homosexuality and mental health* (pp. 207-226). Washington, DC: American Psychiatric Press.
- David, W.J. (1997). *Reaching Out : Interpersonal Effectiveness and Self-Actualization*. 6th ed. Needham Heights: Allyn & Bacon.
- de Monteflores, C. (1993). Notes on the management of difference. In L. D. Garnets & D. C. Kimmel (Eds.), *Psychological perspectives on lesbian and gay male experiences* (pp. 218-247). New York: Columbia University Press.

- Dew, B. J., Myers, J. E., & Wightman, L. F. (2005). Wellness in adult gay males: Examining the impact of internalized homophobia, self-disclosure, and self-disclosure to parents. *Journal of LGBT Issues in Counseling, 1*, 23-40.
- Fassinger, R. E., & Miller, B. A. (1996). Validation of a model of sexual identity development for a sample of gay men. *Journal of Homosexuality, 32*, 53-79.
- Gonsiorek, J. C. (1995). Gay male identities: Concepts and issues. In A. R. D'Augelli & C. J. Patterson (Eds.), *Lesbian, gay, and bisexual identities over the lifespan: Psychological perspectives* (pp. 24-47). New York: Oxford University Press.
- Hamachek, Don. (1992). *Encounters with the self*. (4th ed). Fort Worth: Holt, Rinechart and Winston.
- Herek, G. M., Cogan, J. C., Gillis, J. R., & Glunt, E. K. (1997). Correlates of internalized homophobia in a community sample of lesbians and gay men. *Journal of the Gay and Lesbian Medical Association, 2*, 17-25.
- Herek, G. M. (2004). Beyond "Homophobia": Thinking about sexual prejudice and stigma in the twenty-first century. *Journal of National Sexuality Resource Center, 1*, 6-24
- Hill, C.E., Knox, S., Thomson, B.J., Williams, E.N., Hess, S.A., & Ladany, N. (2005). Consensual qualitative research: An update. *Journal of Counseling Psychology, 52*, 196-205.
- Hillier, L. & Harrison, L. (2007). Building realities less limited than their won: young people practicing same-sex attraction on the internet. *Sexualities, 10*(1), 82-100
- Jackson, P. (1999). Tolerant but unaccepting : The myth of a thai gay paradise. In Peter Jackson and Nerida M.Cook.(eds.) *Genders & Sexualities in Modern Thailand*. , ChiangMai: Silkworm Books.
- Jackson, P. (2000). An Explosion of Thai Identities: Global queering and re-Imaging queer theory. *Culture,Health & Sexuality, 2*(4), 405-424.
- Kimmel, D. C. (2004). Homophobia. *Encyclopedia of Applied Psychology, 2*, 209-214.
- Laird, J. (1996). Invisible ties: Lesbians and their families-of-origin. In J.Laird & R. Green (Eds.), *Lesbians and gays in couples and families: A handbook for therapists* (pp. 89-122). San Francisco: Jossey-Bass.
- Maddi, S. R. (1996). *Personality theories: A comparative analysis*. (6<sup>th</sup> ed). New York: Brooks/Cole.
- McCarn, S. R., & Fassinger, R. E. (1996). Re-visioning sexual minority identity formation: A new model of lesbian identity and its implications for counseling and research. *The Counseling Psychologist, 24*, 508-534.
- Rogers, C.R. (1951). *Client-centered therapy: Its current practice, implecations, and theory*. Boston: Houghton Mifflin.
- Rogers, C.R. (1961). *On becoming a person*. Boston: Houghton Mifflin.
- Rogers, C.R. (1969). *Freedom to Learn: A View of What Education Might Become*. (1st ed.) Columbus, Ohio: Charles Merill.
- Rogers, C.R. (1974). *Psychotherapy and personality change*. Chicago: University of Chicago.



- Sharpe, S. (2002) 'It's just really hard to come to terms with': young people's views on homosexuality. *Sex Education*, 2(3), 263-77.
- Smith, K.T. (1971) Homophobia: a tentative personality profile. *Psychological Reports*, 29, 1091-4.
- Thomas, A.B., Ross, M. W. and Harris, K.K. (2007) Coming out online: interpretations of young men's stories. *Sexuality Research and Social Policy*, 4(2), 5-17.
- Troiden, R. R. (1979). Becoming homosexual: A model of gay identity acquisition. *Psychiatry: Journal for the Study of Interpersonal Processes*, 42, 362–373.

The logo for 'iafor' is centered on the page. It consists of the lowercase letters 'iafor' in a light blue, sans-serif font. The text is enclosed within a large, stylized circular graphic composed of two overlapping, hand-drawn style arcs. The outer arc is a light red color, and the inner arc is a light blue color, matching the text. The arcs are not perfectly circular and have a slightly irregular, brush-stroke-like appearance.



Table 1. The experience of self-acceptance of sexual orientation in gay men

Domain	Category	Subcategory	Frequency
1. Beginning to sense one's own homosexual orientation	1.1 Sensing of gay vibe		10/10(general)
	1.2 The attraction to heterosexual		7/10(typical)
	1.3 Self-denial of the gay sense		3/10(variant)
2. Experiences that facilitate adopting gay identity	2.1 Encountering with social prejudice	2.1.1 Being discriminated from society	5/10(typical) 3/10(variant)
		2.1.2 Reaction to negatively bias of social	
	2.2 Having a sexual experience and relationship with men	2.2.1 Having a sexual experience with a man	6/10(typical) 4/10(variant)
		2.2.2 Having a romantic relationship with a man	9/10(general)
	2.3 The acceptance of same-sex attracted feeling		
	3. Sexual identity acceptance	3.1 The acceptance of gay identity	
3.2 The attitudes toward society with self-acceptance			6/10(typical)
3.3 Entering to gay society			8/10(typical)
4. Disclosure of the gay identity	4.1 Self-disclosures to family	4.1.1 Fear and anxiety to reaction of family member	7/10(typical) 7/10(typical)
		4.1.2 Perceiving attitude of family member toward being gay	8/10(typical)
		4.1.3 Readiness in coming out to family member	6/10(typical)
	4.2 Self-disclosures to society	4.2.1 The attitude of their living society and the choice of coming out	7/10(typical)
		4.2.2 Living in society that is open in	7/10(typical)

Domain	Category	Subcategory	Frequency
		diversity 4.2.3 Balancing in coming out	
5. Living a gay life	5.1 Perceiving difficulties of living a gay life		7/10(typical)
	5.2 To live harmoniously with oneself and with others	5.2.1 Having a commitment to self-development	6/10(typical)
		5.2.2 Focusing of parent and family member	7/10(typical)
6. Emerging of integrated personality	6.1 Integrating gay identity to self identity		9/10(general )
	6.2 Emerging a coherent and integrated self		9/10(general )

*Relations between Intention to Self-change and Cognitions of benefit and Cost to Self-change in University Students*

Yuta Chishima

University of Tsukuba, Japan

0305

The Asian Conference on Psychology & the Behavioral Sciences 2013

Official Conference Proceedings 2013

Abstract

The purpose of this study was to examine the relationship between self-change intention and perceived costs and benefits of this self-change among university students. Although it is well known that many university students desire to change themselves, few studies have examined how students perceive the benefits and costs of these changes. It was hypothesized that the self-change intention would be positively correlated with positive cognitions related to that change. A questionnaire survey was administered to 91 Japanese university students (men = 39, women = 49, non-respondents = 3; mean age = 18.66,  $SD = 2.08$ ) in October and November 2012. Participants responded to the five items assessing self-change intention on a 5-point Likert-type scale and wrote about their cognitions related to the benefits/costs of self-change/maintenance. The number of descriptive comments ranged from 0 to 3. There were 116 descriptive comments related to the benefits of change, and most of them fell within the “self-growth” category. There were 70 descriptive comments related to the costs of change, and most of these descriptive comments fell within the “energy demands” category. Conversely, there were 86 descriptive comments related to the benefits of maintenance, with most falling within the “easiness” category. There were 96 descriptive comments related to the costs of maintenance, with most falling within the “increasing negative thoughts about myself” category. A correlation analysis between scores on the self-change intention and the number of descriptive comments regarding the benefits/costs toward self-change/maintenance indicated that the self-change intention was positively correlated with only costs of self-maintenance ( $r = .24, p < .05$ ). Thus, it appears that weighing the perceived costs of maintenance rather than perceived benefits of change would likely promote self-change intention.

Keywords: Self, Self-change, Benefits and costs, University students

## **Introduction**

### **Intentional self-change among university students**

Many university students are eager to change themselves (Hatase, 2000; Mizuma, 2003). Therefore, concepts related to intentional self-change have been examined, such as “self-improvement motivation” (Taylor, Neter, & Wayment, 1995) and “possible selves” (Markus & Nurius, 1986). However, only a few studies have examined how or why university students want to change themselves. The willingness to change one’s self is referred to as “self-change intention” (exemplified by statements such as “I want to change myself” and “I don’t want to continue to be what I am now”). The current study empirically examined the self-change intention. Assessments of self-change intentions could provide important knowledge for understanding mental adjustment among university students. For instance, Polivy & Herman (2002) showed that failures of self-change attempt could lead to disappointed mood states. Moreover, Klingemann, Sobell, & Sobell (2010) indicate a lack of research regarding the mechanisms individuals use when deciding to make self-changes.

Mizuma (2003) mentions that the intention to change one’s self can encourage self-development. Moreover, Tanaka (2011) revealed that around 88% of university students want to change. Therefore, it appears that the self-change intention is an important factor in university students’ growth and development. One limitation of past studies, though, is that the characteristics that influence a student’s desire to change have not been assessed.

### **Aspects university students desire to change**

Kiecolt & Mabry (2000) observed 6 categories of self-change for university students: “improve work habits, be more goal-oriented,” “become a better or nicer person,” “improve appearance or physique,” “be more outgoing or engaged,” “be more confident or optimistic,” and “manage negative emotions.” These are types of desirable self-images for university students. However, a couple of questions remain: how does self-change intention occur and what aspects do individuals want to maintain rather than change?

### **Model of intentional self-change**

Kiecolt (1994) developed a 4-part model for self-change decisions (Figure 1), which

details the process by which an individual comes to the decision of changing an aspect of the self. First, there is the “impetus to change oneself” (A), including unfavorable reflected appraisals and reduced self-esteem. The second is the “conditioning factor” (B) that can include the following: a stressor that is identity-relevant, a belief that self-change is possible, and the cognition that the benefits of change outweigh the costs. The third component is the “critical event” or “turning point” (C). However, some individuals do not go through this step and move directly to the final step. The final step is the “appraisal” (D), which refers to the actual decision to change oneself. The current study focused on “reduced self-esteem” and the “benefits of self-change,” specifically addressing the benefits and costs of change.

### Purpose & hypotheses

Based on previous research, the current study examined information related to self-change intentions with a focus on self-esteem and cognitions related to the benefits of change. The first hypothesis is that self-change intention will be negatively related to self-esteem. The second hypothesis is that self-change intention will be positively related to the perceived benefits of self-change. These hypotheses are based on Kiecolt’s (1994) model of self-change.

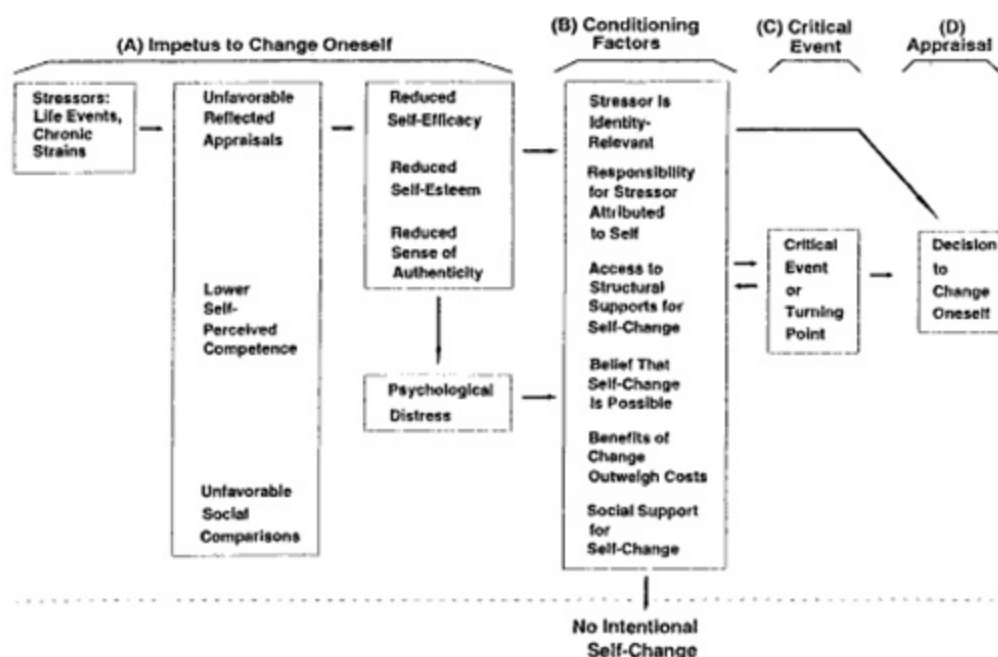

Figure 1 Model for the decision to change oneself (Kiecolt, 1994)

### Methods

#### Participants

Participants were 91 Japanese university students aged 18–25 years (39 men, 49

women, 3 who did not provide their gender; mean age = 18.66 years,  $SD = 2.08$ ).

## Measures

**Self-change intention scale.** This scale was developed specifically for the current study. The scale consists of 5 items rated on a 5-point Likert-type scale ranging from (1) “does not apply at all” to (5) “applies exactly,” with higher scores reflecting stronger intentions toward self-change. Examples of some items are, “I want to change myself” and “I want to stay the way I am.”

**Self-esteem scale.** This 10-item scale was developed by Rosenberg (1965) and consists of 10 items. Each item uses a 5-point Likert-type scale ranging from (1) “does not apply at all” to (5) “applies exactly,” with higher scores reflecting higher self-esteem.

**Aspects one intends to change.** To examine what the university students wanted to change about themselves, the following open-ended sentence was prepared: “I want to change \_\_\_\_\_ about myself.” Students could also answer, “I don’t want to change anything about myself.” by checking a box on the questionnaire. Additionally, students were asked what they did not want to change: “I don’t want to change \_\_\_\_\_ about myself.” Again, students could also answer, “I don’t have anything I don’t want to change about myself” Students gave 5 responses to each question. The answers were then counted. If a student said they had nothing they wanted to change, or had nothing they did not want to change, the response was counted as 0.

**Perceived benefits/costs of self-change/self-maintenance.** Space was provided in the questionnaire to collect descriptive comments of the perceived benefits/costs of self-change/maintenance. Students were also allowed to check a box saying, “I think there aren’t any benefits of change.” The number of descriptive comments was counted, and checking the box was counted as 0.

## Procedures and ethical considerations

This study was conducted in October and November 2012. The questionnaires were distributed to the participants and picked up during lecture sessions. Participants were instructed that they could skip any questions they did not wish to answer, and that they would not be individually associated with their data.



## Results

### Categorization of aspects related to intended changes

The 274 descriptive comments of traits students wanted to change were placed into 5 categories based on similarity (Table 1): *lazy*, *not assertive*, *inconsiderate*, *inactive*, and *not self-confident*. The category with the greatest number of responses was Lazy. Two participants checked the sentence, “I don’t want to change anything about myself.” The average number of descriptive comments for each student was 3.11.

The 163 descriptive comments of traits students did not want to change were placed into 6 categories (Table 1): *persevering*, *being authentic*, *communicating well*, *having a positive attitude*, *goal oriented*, and *having social circumstances*. Twelve participants checked the sentence, “I don’t have anything I don’t want to change about myself.” The average number of descriptive comments for each student was 1.90.

Table 1 Categories of the traits participants desired to change/maintain

Categories participants desired to change		Categories participants did not desired to change	
1 Lazy	83	1 Persevering	39
2 Not assertive	62	2 Being authentic	32
3 Inconsiderate	46	3 Communicating well	32
4 Inactive	38	4 Having a positive attitude	28
5 Not self-confident	38	5 Goal-oriented	16
		6 Having social circumstances	6
Others	7	Others	10
Sum	274	Sum	163

### Categorization of benefits/costs and self-change/self-maintenance

Descriptive comments of benefits/costs of self-change/self-maintenance were also categorized (Table 2). The 116 descriptive comments regarding the benefits of self-change were categorized into *self-growth*, *having good relationships*, *gaining confidence*, etc. The 70 descriptive comments regarding the costs of self-change were categorized into *energy demands*, *increased stress*, *loss of identity*, etc. The 86 descriptive comments regarding the benefits of self-maintenance were categorized into *easiness*, *becoming authentic*, *safety and relief*, etc. The 96 descriptive comments regarding the costs of self-maintenance were categorized into *increasing negative thoughts about myself*, *increasing anxieties*, *bad effects on relationships*, etc.

Table 2 Categories of benefits/costs to change/maintenance

		Self-change		Self-maintenance	
Benefits	Self-growth	28	Easiness	42	
	Having good relationships	22	Becoming authentic	14	
	Gaining self-confidence	19	Safety and relief	11	
	⋮	⋮	⋮	⋮	
Sum		116	86		
Costs	Energy demands	25	Increasing negative thoughts about myself	22	
	Increased stress	21	Increasing anxieties	16	
	Loss of identity	12	Bad effects on relationship	14	
	⋮	⋮	⋮	⋮	
Sum		70	96		

### Correlations between self-change intention and the number of aspects identified as needed for positive change and self-esteem

A correlation analysis was conducted to examine the relationship between self-change intention and the number of aspects identified as needed (or not) for change and self-esteem (Table 3). Self-change intention was positively and significantly related to the number of aspects the students intended to change ( $r = .25, p < .05$ ) and vice versa ( $r = -.24, p < .05$ ). Self-change intention was negatively and significantly correlated with self-esteem ( $r = -.41, p < .001$ ). These results suggest that self-change intention was correlated with the identification of several aspects related to change, as well as self-esteem.

Table 3 Correlations between self-change intention and both the number of aspects intended to change and self-esteem

	Aspects participants intended to change	Aspects participants did not intend to change	Self-esteem
Self-change intention	.25 *	-.24 *	-.41 ***

Note ) † $p < .10$ , \* $p < .05$ , \*\* $p < .01$ , \*\*\* $p < .001$

### Correlations between self-change intention and the number of benefits and costs to change

A correlation analysis was conducted to examine the relationship between self-change intention and the number of benefits and costs to change (Table 4). Self-change intention was positively and significantly correlated with the number of costs of self-maintenance ( $r = .24, p < .05$ ). However, there was no significant correlation

between self-change intention and benefits of change ( $r = .10, n.s.$ ). These results suggest that self-change intention was only associated with cognitions related to costs for self-maintenance.

Table 4 Correlations between self-change intention and the number of benefits/costs to change/maintain

	Benefits of self-change	Costs of self-change	Benefits of self-maintenance	Costs of self-maintenance
Self-change intention	.10	.00	-.06	.24 *

Note ) † $p < .10$ , \* $p < .05$ , \*\* $p < .01$ , \*\*\* $p < .001$

## Discussion

### Conclusion

The first hypothesis was that self-change intention would negatively correlate with self-esteem. The present results support this hypothesis, as well as predictions from Kiecolt's (1994) model. The second hypothesis was that self-change intention would positively correlate with cognitions related to the benefits of self-change. The present results did not support the second hypothesis. However, the costs of self-maintenance were positively correlated with the intention to change. This result suggests that the decision to change the self is a more present-focused intention than a future-focused intention. In other words, people who want to change themselves likely think more about their current selves as opposed to their future selves. Thus, self-change intention might be driven by a desire to escape the current self rather than seeking a possible self. In sum, the present study revealed that self-change intention is strengthened by having many traits that can be targeted for change, low self-esteem, and realization of the costs of maintaining the current self.

### Further research

The current study highlighted the relationship between self-change intention and the perceived benefits/costs of change. However, the current study examined benefits and costs separately. Most students who desire change will address both benefits and costs, which can lead to conflict associated with change. Therefore, conflicts that arise due to expectations from both benefits and costs should be examined in future research. Miller & Rollnick (2002) suggest that conflict resolution is important in order to encourage change. Lewin's 3-conflict pattern (1935) is useful when examining

conflicts to self-change. For example, the Approach-Approach conflict refers to the notion that, “changing has benefits, and maintenance also has benefits.” Avoidance-Avoidance conflict refers to the notion that, “changing has costs, and maintenance also has costs.” Approach-Avoidance conflict refers to the notion that, “changing has both benefits and costs.” Future research should clarify the conflicts that arise with self-change by using these conflict patterns in order to help university students change toward a desired self.

## References

- Kiecolt, K. J. (1994). Stress and the decision to change oneself: A theoretical model. *Social Psychology Quarterly*, **57**, 49-63.
- Kiecolt, K. J., Mabry, J. B. (2000). Agency in young adulthood: Intentional self-change among college students. *Advances in Life Course Research*, **5**, 181-205.
- Klingemann, H., Sobell, M. B., & Sobell, L. C. (2010). Continuities and changes in self-change research. *Addiction*, **105**, 1510-1518.
- Lewin, K. (1935). A dynamic theory of personality. New York: McGraw-Hill.
- Markus, H., & Nurius, P. (1986). Possible selves. *American Psychologist*, **41**, 954-969.
- Miller, W. R., & Rollnick, S. (2002). Motivational interviewing : Preparing People for Change. 2nd ed. New York: Guilford Press.
- Mizuma, R. (2003). Feelings of Self-Disgust and Self-Development : The Intention to Change the Negative Self. *Japanese Journal of Educational Psychology*, **51**, 43-53.
- Polivy, J., & Herman, C. P. (2002). If at first you don't succeed: False hopes of self-change. *American Psychologist*, **57**, 677-689.
- Rosenberg, M. (1965). Society and the adolescent self-image. Princeton, NJ: Princeton University Press.
- Tanaka, M. (2011). Positive view of self-change from the perspectives of self-affirmation, aspiration, time perspective, and generalized self-efficacy. *Japanese Journal of Microcounseling*, **6**, 12-23.
- Taylor, S. E., Neter, E., & Wayment, H. A. (1995). Self-evaluation processes. *Personality and Social Psychology Bulletin*, **21**, 1278-1287.

*Consideration of Cross-cultural Issues in Relation to Somatization*

Ming Meng\*<sup>1</sup>, Yue Ling Jin\*<sup>2</sup>

\*<sup>1</sup>Deakin University, Australia, \*<sup>2</sup>ShangHai Health Vocational & Technical University,  
China

0312

The Asian Conference on Psychology & the Behavioral Sciences 2013

Official Conference Proceedings 2013

Abstract

This article discusses the contribution of socio-cultural factors to somatization. Somatization is characterized as the expression of psychological distress in the form of bodily complaints, accompanied by medical seeking behaviours. A review of cross-cultural epidemiological research highlighted that the experience and expression of psychological distress varies across different ethnic groups, which provides cultural relevance in the shaping of somatization. The effect of culture on somatization is characterised by a process of communication and negotiation with distinctive social and cultural requirements and conditions. In Chinese culture, psychological distress causes a higher level of personal and family's stigmatization. Chinese are less likely to express and communicate emotionally in relation to their distress. This helps explain why expression of psychological distress in a somatic form is more common in China than in Western countries. Future research into somatization needs to have an increased focus on understanding the personal and social meanings behind culture.

*Keywords:* Somatization, Culture, Alexithymia, Stigma, Psychological Distress, Parental Emotion Socialization

iafor

The International Academic Forum

[www.iafor.org](http://www.iafor.org)

Physical symptoms that cannot be diagnosed as an identified medical disease, results in a variety of primary care issues (Kroenke et al., 1994; Fink et al., 1999). Somatization, as a possible phenomenon for explaining unexplained physical symptoms, has drawn attention from both psychological and medical scientists and clinicians over recent decades. Individuals with somatization often expressed their psychological distress as somatic symptoms (Fabrega, 1990; Heinrich, 2004). Somatization has been examined both in western and non-western countries by medical anthropologists and psychiatrist. Previous research has revealed the prevalence and features of somatization vary amongst cross cultural or ethnic groups (Chang, 1985; Parker et al., 2001). Some cross-cultural studies proposed that Chinese are more likely to present emotional distress somatically than their Western counterparts (Chang, 1985; Parker et al., 2001) and by extension they see somatization as featuring more predominantly in certain cultures. This article will discuss the cultural factors, such as, individual values, family and social networks which contributes to expressions of emotional distress.

### **Definition of Somatization**

The concept of somatization, generally proposed by contemporary researchers, refers to three aspects: 1) unexplained physical symptoms linked to the occurrence of psychological distress; 2) attribution of physical illness (i.e., excessive bodily preoccupation and worrying about illness); and 3) seeking medical help for the physical symptoms (Clarke et al., 2008; Fabrega, 1990). This implies that somatic symptoms are experienced and not feigned. When the physical symptoms become persistent, severe and disabling, or induce excessive concern about a disease, individuals seek medical attention. Where physical symptoms are not apparent in identifiable findings or are not consistent with conventional medical diseases, they are often called 'medically unexplained symptoms' (Fink et al., 2005; Rief & Sharpe, 2004). This phenomenon is not only apparent in primary care but is also found in the broader community, with a wide spectrum of severity that ranges from mild self-reported unpleasant bodily sensations to multiple physical symptoms that are often reoccurring and which can be chronic, and disabling (Hiller et al., 2006; Katon et al., 1991). As a result, a broad conceptualisation of somatization is often adopted by researchers, (Eriksen et al., 1998; Woolfolk & Allen, 2007). Somatization disorder is viewed as an extreme form on the continuum, while most cases, with unexplained symptoms, are not regarded as being sufficiently numerous or diverse to qualify for the diagnosis of a somatization disorder and can be placed on the lower end of the continuum (Smith JR, 1994).

### **Impact of Somatization on Individuals and Society**

Unexplained somatic symptoms, described by people with somatization, often involve multiple organic systems. Physicians often undertake a variety of examinations in an attempt to obtain the correct diagnosis. Repeated failures in identifying the pathological origins of the symptoms can lead to frustration for both the physicians



and individuals with somatic symptoms and can negatively affect the doctor-patient relationship. The patients may be referred to different physicians or specialists for an evaluation of the complaint, or may seek out these additional medical procedures, leading to often unnecessary hospitalizations and treatments (Guze & Perley, 1963) and the excessive use of limited medical resources.

Attention has been focused on the abnormal behaviours of people with somatization, extending beyond medical settings to their workplaces and households. Due to repeatedly seeking medical attention, the individuals frequently take sick leave from work, reducing work time and increasing the risk of them losing their jobs and can result in a sense of alienation from their family members and friends leading to a disrupted life. Medical examinations and treatments elevate costs, bringing additional burden to the individuals. Smith JR (1994) indicated that people, diagnosed with somatization disorder, use health resources nine times more than the general population. In order to avoid high expenditures on health care system and by individuals on unnecessary laboratory investigations and medical interventions and to decrease various negative effects on individuals, family and society, an adequate identification and interpretation, of the somatization, is essential in helping acquire effective interventions in clinical practice.

### **Demographic Characteristics of Somatization**

The demographic characteristics most associated with somatization are sex, ethnicity, and socio-economic status. Research of general populations, performed by Eriksen and his colleagues (1998), across the counties of Denmark, Finland, Norway and Sweden, found that women were twice as likely as men to experience tiredness, headache, migraine, depressive mood, neck pain and arm/shoulder pain and were 50-66% more likely to report worry, upper back pain, and feet pain than men (Eriksen et al., 1998). A more recent study has also highlighted a higher incidence of somatization in female groups. The low prevalence of somatization in men may be explicated, to the male stereotype of a disinclination to admit psychological distress or seek medical help (Wool & Barsky, 1994). In general practice, somatization is less likely to be viewed as a possible explanation for male symptoms (Golding et al., 1991). Thus, gender may be a predictor for the level of occurrence of somatization.

Epidemiological research has suggested the phenomenon of somatization is associated with lower social classes, educational levels and household income (Fink et al., 1999; Hiller et al., 2006). An empirical study performed by Fink et al., (1999) found that: 62.5% of people with somatization had no more than a primary level education; 50% were unskilled and 43.5% were unemployed or on a pension. Similarly, Hiller et al., (2006), indicated that somatization, of any degree, is more likely to appear in people who are lower educated, have poor economic status, and live in less urbanized areas.

Studies on ethnicity have revealed less consistent findings. Robins & Reiger's (1991) did not find differences between Hispanics and non-Hispanics in incidences of

somatization. However, a number of studies reported a higher prevalence of somatization in Asian countries over western countries (Farooq, et al., 1995; Ryder et al., 2008). Research from Ryder and his coworkers' (2008) proposed that Chinese reported more somatic symptoms than Euro-Canadians. However predicting the prevalence of somatization across counties may involve more social and cultural factors, rather than a single effect of ethnicity (Kirmayer & Young, 1998).

### **Cultural and Somatization**

Cultural differences in the expression of somatization have been proposed by some researchers (Farooq et al., 1995; Kleinman, 1986; Kirmayer, 2001; Mak & Zane, 2004). In recent decades, somatization has been variously described as a 'cultural idiom of distress' based on a process of communication and negotiation with social and personal conditions and requirements (Kleinman, 1986). The phenomenon of somatization varies in frequency and intensity across different ethnic and cultural groups. Eastern, and in particular Chinese, culture is more likely to present emotional distress in somatic symptoms: Empirical research conducted by Chang (1985) suggested that Chinese subjects reported more physical problems, compared with white and black people. While Parker et al., (2001) found that depressed members of the Chinese population scored higher in somatic items and lower in cognitive forms of depression when compared to members of the Australians population. In the west there is a greater likelihood to express affective or cognitive complaints such as depressive moods, pessimism, or low self-esteem (Parker et al., 2001).

### ***The Concept of Culture***

Culture is an abstract concept, reflecting the human beliefs, values, and attitudes that shape understandings and patterns of behaviour (Kirmayer, 2001; William & Sewell, 1999). In the history of human existence, culture, as the main component of social life, presents a dynamic construction accompanied by changes in dimensions of both time and space (Kirmayer, 2001). The evolution of culture is complex involving a continuous interplay between individuals and society. Individuals employ customs, institutions, habits and practices (William & Sewell, 1999) to establish norms of social acceptability (Kirmayer, 2001). The emergence of such cultural practices has distinctive social, ethnic and geographic elements (Kirmayer & Sartorius, 2007). In this way, culture is recognised as a distinguishing element of ethnicity, age, and geographical regions, establishing distinctive ways of life for particular societal groups. By extension, if we understand culture, then we can be expected to also understand the meaning of actions, behaviours and thinking on social groupings. Culture, in human phenomena, has been further exhibited in the investigation of aspects of human health encompassing illness experiences and behaviours (Kirmayer & Sartorius, 2007).

### ***Difference of Parental Emotion Socialization in Somatization***

Culture plays an important role in shaping emotional experiences. Asian societies are

less likely to exhibit their emotions in both non-verbal (ie., physical affection) and verbal aspects than Europeans. Family is the first place in which children observe, experience, and learn about emotions. Individuals' behaviour reflecting beliefs, values and goals are used to socialise their children in learning expressions and modulations of emotions (Eisenberg et al., 1998). This process is referred to as "parental emotion socialization", involving parental discussion and parental reactions to children's emotions (Eisenberg et al., 1998). In childrearing practice, emotional socialization, provided by the parental influence, is based on the distinct beliefs, values, and behaviours that are consistent with cultural values (Lutz, 1983). Asian parental socialization is presented as less affectionate and more restrictive, authoritarian, and controlling in the instruction of their children than western socialization practices. In Japanese culture, parents tend to discourage their children from displays of emotion, while, by contrast, Miller, Fung, and Mintz (1996) found that parents in America are more willing to encourage their children to express such emotions. Given this, an individual's cultural beliefs, norms, and values may account for variations in the communication of emotions.

### ***The Role of Stigma in Somatization***

The tendency towards somatization amongst Chinese groups can be linked to traditional Chinese culture, that is, languages of emotion are not viewed as an appropriate expression for visiting medical doctors (Kleinman, 1986). In Chinese culture, mental problems are often viewed as indicating a lack of fortitude or strength, leading to a stigmatization of the person and even the family unit (Parker et al., 2001; Xu, 2004). As a result families will often not report a family member's mental illness in order to avoid a loss of face or discrimination and alienation (Xu, 2004), which extends the issue beyond one of health, to a social or moral problem. The somatic expression of emotional distress provides a blameless and non-stigmatized reason for seeking medical help and has been referred to as "ticket behaviour" (Epstein et al., 1999). For instance, a Kleinman's study employed in a Chinese psychiatric clinic showed that while 30% of the subjects were diagnosed as neurasthenia, only 1% met a diagnosis of depression (Kleinman, 1986). The term neurasthenia, called '*shen jing shuai ruo*' (SJSR), is a Chinese expression which means 'weakness of nerves'. It is a collective diagnosis encompassing a wide variety of physical symptoms, such as, headaches, insomnia, fatigue, dizziness, nervousness and simultaneous depressive symptoms (Kleinman, 1986; Kirmayer & Sartorius, 2007). This avoiding of expressions of emotional distress increases the difficulties in identifying psychological problems (Parker et al., 2001).

In western clinical psychology, somatization has been viewed as a psychosomatic process and has been stigmatized (So, 2008). People with somatization often face shame and a perception that they are wasting precious healthcare resources (Kirmayer, 2001). To avoid prejudice and stigmatization in the mainstream medical community, somatization sufferers often prefer to discuss their problems with family members, spiritual elders, or community leaders, rather than primary care physicians (Kirmayer,

2001). While somatization is often considered as a fake condition in some western cases, the negative effects of psychological stigma on individual and family are relatively small, compared with cases in eastern countries. Therefore, stigma can be an explanation as to the greater likelihood of psychological somatic distress in eastern over western culture.

### ***Personality Implication in Somatization***

The importance of culture in the experience and expression of emotions has also been reflected in personality traits, especially the alexithymia personality. Alexithymia is a personality construct that implies cognitive and affective styles and appears to be a risk factor in developing somatization (Wise & Mann, 1994). The alexithymia trait is described as difficulties in identifying and verbalizing affective distress, impoverishment of fantasy, and a poor capability for externally oriented thinking (Mattila et al., 2008; Sifneos, 1973; Wise & Mann, 1994). From a theoretical postulation, the lacking of mental representations of emotion in alexithymic individuals may result from a deficit in the cognitive process (Mattila et al., 2008). The cognitive form that may link somatization with alexithymia is manifested by amplifying the somatic sensations or misinterpreting these as symptoms of disease, when associated with emotional arousal (Mattila et al., 2008). The association between somatization and alexithymia has been implied in extensive research (De Gucht & Heiser, 2003; Mattila et al., 2008). A recent study demonstrated elevated somatization reporting in alexithymic individuals (Mattila et al., 2008), while Pennebaker and Watson (1991) found that alexithymia is statistically significantly when correlated with somatization. In addition, earlier literature pointed out that alexithymic individuals are more likely to be introverted and feel depressed or anxious (Taylor et al., 1997; Wise & Mann, 1994). Introverted individuals often suffer from low energy levels and less social activity and are disposed towards depression. Individuals with depression are likely to report increased somatic symptoms with selective bias in the information provided. This evidence is consistent with augmentation of somatic symptoms as a result of alexithymia personality traits. Research has found strong connections between somatization and emotional factors in Asian cultures. For example, a Canadian college study showed higher levels of alexithymia amongst Chinese language students than amongst native English and European students. This means that the relationship between somatization and alexithymia can be seen as more significant in Asian cultures.

### **Conclusion**

Previous cross-culture research has suggested the influence of culture on somatization. Asian culture, especially Chinese culture, is more likely to make Chinese to express their psychological distress as physical symptoms than western culture. This article provides an explanation of how socio-cultural components shape the unexplained physical symptoms from three perspectives of parental emotion socialization, personality traits, and stigma. To date, culture provides a context for the way of experience, expression, and communication of psychological distress. Culture

difference in somatization determines the resource of psychological distress and the form of illness experience. Given this, the culture implication of somatization goes beyond the characteristics of geography or ethnicity into the personal and social meanings in associated with culture values, beliefs, and norms.

### References

- Chang, W. C. (1985). A cross-cultural study of depressive symptomatology. *Culture, Medicine and Psychiatry*, 9, 295-317.
- Clarke, D. M., Piterman, L., Byrne, C. J., & Austin, D. W. (2008). Somatic symptoms, hypochondriasis and psychological distress: A study of somatisation in Australian general practice. *The Medical Journal of Australia*, 189(10), 560-564.
- De Gucht, V., & Heiser, W. (2003). Alexithymia and somatisation: A quantitative review of the literature. *Journal of Psychosomatic Research*, 54(5), 425-434.
- Eisenberg, N., Spinrad, T. L., & Cumberland, A. (1998). The socialization of emotion: Reply to commentaries. *Psychological Inquiry*, 9, 317-333.
- Eriksen, H. R., Svendsrod, R., Ursin, G., & Ursin, H. (1998). Prevalence of subjective health complaints in the Nordic European countries in 1993. *The European Journal of Public Health*, 8(4), 294-298.
- Fabrega, H. (1990). The concept of somatisation as a cultural and historical product of Western medicine. *Psychosomatic Medicine*, 52(6), 653-672.
- Farooq, S., Gahir, M. S., Okyere, E., Sheikh, A. J., & Oyeboode, F. (1995). Somatisation: A transcultural study. *Journal of Psychosomatic Research*, 39(7), 883-888.
- Fink, P., Rosendal, M., & Olesen, F. (2005). Classification of somatisation and functional somatic symptoms in primary care. *Australian and New Zealand Journal of Psychiatry*, 39, 772-781.
- Fink, P., Sørensen, L., Engberg, M., Holm, M., & Munk-Jørgensen, P. (1999). Somatisation in Primary Care: Prevalence, Health Care Utilization, and General Practitioner Recognition. *Psychosomatics*, 40(4), 330-338.
- Golding, J. M., Smith, G. R., & Kashner, M. (1991). Does somatisation disorder occur in men?: Clinical characteristics of women and men with multiple unexplained physical symptoms. *Archives of General Psychiatry*, 48, 231-235.
- Guze, S. B., & Perley, M. I. (1963). Observations on the natural history of hysteria. *American Journal Psychiatry*, 119, 960-965.
- Heinrich, T. W. (2004). Medically unexplained symptoms and the concept of somatisation. *Wisconsin Medical Journal*, 103(6), 83-87.
- Hiller, W., Rief, W., & Brähler, E. (2006). Somatization in the population: From mild bodily misperceptions to disabling symptoms. *Social Psychiatry and Psychiatric Epidemiology*, 41(9), 704-712.
- Katon, W., Lin, E., Von Korff, M., Russo, J., Lipscomb, P., & Bush, T. (1991). Somatisation: a spectrum of severity. *American Journal of Psychiatry*, 148(1), 34-40.



- Kleinman, A., Anderson, J., Finkler, K., Frankenberg, R., & Young, A. (1986). Social origins of distress and disease: Depression, neurasthenia, and pain in modern China. *Current anthropology*, 24(5), 499-509.
- Kirmayer, L. J. (2001). Cultural variations in the clinical presentation of depression and anxiety: Implications for diagnosis and treatment. *Journal of Clinical Psychiatry*, 62(SUPPL. 13), 22-30.
- Kirmayer, L. J., & Young, A. (1998). Culture and somatisation: Clinical, epidemiological, and ethnographic perspectives. *Psychosomatic Medicine*, 60(4), 420-430.
- Kirmayer, L. J., & Sartorius, N. (2007). Cultural models and somatic syndromes. *Psychosomatic Medicine*, 69(9), 832-840.
- Kroenke, K., Spitzer, R. L., Williams, J. B. W., Linzer, M., Hahn, S. R., deGruy, F. V., et al. (1994). Physical symptoms in primary care: Predictors of psychiatric disorders and functional impairment. *Archives of Family Medicine* 3, 774-779.
- Lutz, C. (1983). Parental goals, ethnopsychology, and the development of emotional meaning. *Ethos*, 11, 246-262.
- Mattila, A. K., Kronholm, E., Jula, A., Salminen, J. K., Koivisto, A. M., Mielonen, R. L., Joukamaa, M. (2008). Alexithymia and somatisation in general population. *Psychosomatic Medicine*, 70(6), 716-722.
- Miller, P. J., Fung, H., & Mintz, J. (1996). Self-construction through narrative practices: A Chinese and American comparison of early socialization. *Ethos*, 24, 1-44.
- Parker, G., Cheah, Y. C., & Roy, K. (2001). Do the Chinese somatize depression? A cross-cultural study. *Social Psychiatry and Psychiatric Epidemiology*, 36(6), 287-293.
- Rief, W., & Sharpe, M. (2004). Somatoform disorders - New approaches to classification, conceptualization, and treatment. *Journal of Psychosomatic Research*, 56(4), 387-390.
- Robins, L. N., & Reiger, D. (1991). *Psychiatric disorders in America: The Epidemiologic Catchment Area study*. New York: Free Press.
- Ryder, A. G., Yang, J., Zhu, X., Yao, S., Yi, J., Heine, S. J., & Bagby, R. M.. (2008). The cultural shaping of depression: Somatic symptoms in China, psychological symptoms in North America? *Journal of Abnormal Psychology*, 117(2), 300-313.
- Sifneos, P. E. (1973). The prevalence of alexithymic characteristics in psychosomatic patients. *Psychotherapy and Psychosomatics*, 22, 255-262.
- Smith JR, G. R. (1994). The course of somatisation and its effects on utilization of health care resources. *Psychosomatics*, 35(3), 263-267.
- So, J. K. (2008). Somatisation as cultural idiom of distress: Rethinking mind and body in a multicultural society. *Counselling Psychology Quarterly*, 21(2), 167-174.
- Taylor, G. J., Bagby, R. M., & Parker, J. D. A. (1997). *Disorders of affect regulation: Alexithymia in medical and psychiatric illness*. Cambridge, MA: Cambridge University Press.
- William, H., & Sewell, J. (1999). The Concept(s) of culture. In V. E. Bonnell & L.



- Hunt (Eds.), *Beyond the Cultural Turn: New Directions in the Study of Society and Culture*. (pp. 35-61). Berkeley: University of California Press.
- Wise, T. N., & Mann, L. S. (1994). The relationship between somatosensory amplification, alexithymia, and neuroticism. *Journal of Psychosomatic Research*, 38(6), 515-521.
- Wool, C. A., & Barsky, A. J. (1994). Do women somatize more than men?: Gender differences in somatisation. *Psychosomatics*, 35, 445– 452.
- Woolfolk, R. L., & Allen, L. A. (2007). *Treating Somatisation : A Cognitive-Behavioral Approach*. New York :Guilford Press.
- Xu, J. M. (2004), Somatoform disorder and somatisation. *Chinese Journal of Behavioural Medical Science*, 13(3), 359-360.

The logo for 'iafor' is centered on the page. It consists of the lowercase letters 'iafor' in a light blue, serif font. The text is enclosed within a large, stylized circular graphic composed of two overlapping, hand-drawn style arcs. The upper arc is light blue and the lower arc is light red, creating a frame around the text.

*Factoring in the Correct Answers Ratio in a Psycho-Educational Program*

Yukako Nakane, Ayako Ito  
Ochanomizu University, Japan

0320

The Asian Conference on Psychology & the Behavioral Sciences 2013

Official Conference Proceedings 2013

Abstract

**Introduction:** Various prevention programs fall short when it comes to practical application of learned skills. Students should be able to grasp and easily apply these skills in real life. Our psycho-educational program uses familiar conflict scenarios, where students are encouraged to answer assertively. Many students' high/low correct answers ratio varies with the scenarios. We believe the correct answers ratio shed some light on difficulties faced in real life or understanding of students in the scenarios. This study focuses on the correct answers ratio, examines the scenario's factors through a high/low ratio, and gives suggestions on developing an effective program.

**Method:** Participants were junior high school students ( $n = 697$ ). Seven bully-related scenarios were used.

**Results:** Two of the seven scenarios, "Your funny-face picture was uploaded to a friend's blog without your permission." and "An e-mail in which you spoke ill of others was sent to other classmates without your permission" had the lowest correct answers ratio (37.5% and 26.9%, respectively). Many of the wrong answers showed direct signs of aggression. The correct answer ratio was significantly low compared with the other five scenarios ( $\chi^2 = 77.4, p < .01$  and  $\chi^2 = 46.8, p < .01$ , respectively). The highest correct answers ratio was 84.3%. The scenario had minimal harm (emotional or otherwise). Students appear to be more uncontrollable when the harm is greater, because of the stronger students' aggression, and as a result, their answers are not assertive. The correct answers ratio suggests that the timing and manner in which each scenario is presented should be carefully considered.

## Introduction

Bullying is a serious problem in schools. According to the Ministry of Education, Culture, Sports, Science and Technology (2012), the number of bullying cases was higher than the previous year in each stage of education. In elementary schools, for example, there were 88,132 cases, an increase of 166% from the previous year. In junior high schools, 42,751 cases were reported (an increase of 39% from the previous year), and in high schools, 12,574 cases (an increase of 109% from the previous year). To reduce bullying, attention has shifted to preventive measures through education in schools and, consequently, a number of programs are being implemented (see Heydenberk, Heydenberk, and Tzenova, 2006; Tsuda, Katsuma, and Yamasaki, 2011).

The increasing influence of the Internet and cell phone usage and students' greater accessibility to both poses a new challenge. Schools must now address bullying that occurs over the Internet, or cyberbullying. There are a number of definitions for cyberbullying (Vandesbosch and Cleemput, 2009), for example, Patchin and Hinduja (2006) define cyberbullying as "willful and repeated harm inflicted through the medium of electronic text" (p.152). To prevent cyberbullying, programs are being developed that warn children of the dangers of the Internet, ways to respond, and helpful social skills to employ (Nakasato, Kubota, and Hasegawa, 2011; NTT Docomo, 2004).

Yet, the effectiveness of programs that aim to prevent bullying and cyberbullying has been questioned. The types of skills learned in the programs, for instance, are not actually used in real-life situations. In other words, it is not certain whether the programs' contents can be extrapolated to students in general (Okada, Goto, and Ueno, 2005; Shigeyoshi and Otsuka, 2010). Applying learned skills to daily life is challenging because controlling emotions, such as aggression or anxiety, is difficult in real-life situations (Watanabe, Harada, Saito, 2009); moreover, the contents of the program do not correspond with the developmental stage of the students (Harada, 2012). To resolve these issues, the program should contain materials with clear objectives to facilitate students' learning.

We have conducted a psychological education program that teaches interpersonal skills in schools (Nakane, Ito, and Suzuki, 2010). This program creates scenarios of conflict focused on school life that students will be able to relate to and then includes an exercise in which students are asked to think of assertive phrases to use in such scenarios. When assertive responses were designated as the correct answers, the scenarios used in the program contained answers some students could answer correctly and others could not. A scenario for which the percentage of correct answers is too high indicates the scenario may be too easy. When the correct answer ratio is too low,

the scenario may be inappropriate to introduce as exercise material. An examination of the characteristics of scenarios with a low correct answer ratio should offer hints as to which scenarios are difficult for students to apply in their daily lives.

Therefore, this study focuses on the correct answer ratio in the program's exercises, examines the contents of scenarios with a high or low correct answer ratio, and discusses the difficulty level of the program's contents. Accordingly, this study aims to obtain insight into preparing more effective learning materials for psychological education. It should be noted that the scenarios discussed in this report are scenarios relating to bullying and cyberbullying.

## **Method**

### ***Participants***

The study participants were 697 public junior high school students in Tokyo. The students were in the first and second grades and were between 13 and 14 years of age. The 2008–2012 survey results were used.

### ***Program***

The program was designed using the win-win resolution (Littlefield *et al.*, 1993) because it is easy to run, easy to understand, and easy to apply to the scenarios concerning conflicts over interpersonal relationships that junior high school students face in their daily lives. The program aims to teach students assertive communication that can create a win-win situation. The definition of win-win is “both of the parties involved in the conflict end up with pleasant feelings.” Each scenario had three possible patterns: (1) win-win, (2) failure to convey feelings to the other party and subdue oneself, and (3) express what one wants to convey aggressively to other party making him/her feel unpleasant. With patterns (2) and (3), one or both parties end up losing. Students were presented with possible responses relating to these three patterns and were asked to select the win-win response. Then, they were asked to think of a win-win response by themselves and write it down. The flow of the program was as follows: (1) instruction; (2) students learned about how to respond to given scenarios through puppet-based role-play and then responded to each scenario; and (3) students freely wrote their personal reflections on feedback sheets. The program was run chiefly by us and graduate students specializing in psychology. Teachers in charge also participated in the classes as observers.

### ***Procedure***

This report targeted seven of the scenarios (hereunder scenarios 1–7) concerning

bullying and cyberbullying used in the program.

The contents of each scenario are outlined below. For each scenario, the students were asked to describe a way of communicating that would achieve a win-win.

Scenario 1: "Your friend lends your comic book to another person without your permission." In this scenario, the student had lent his/her comic to his/her friend, and the friend then lent it to someone else. The student conveys that the friend should ask for permission when he/she lends something borrowed to someone else and should return the comic immediately. Scenario 2: "Your group members speak ill of a classmate." In this scenario, the student conveys that he/she does not want to participate in the badmouthing of someone else. Scenario 3: "You are ignored by your friend suddenly." In this scenario, the student asks the reason why he/she has suddenly been ignored by the friend he/she had previously been on good terms with. Scenario 4: "You gain an insulting nickname by a friend." In this scenario, the student's friend addresses him/her by an insulting nickname. The student conveys to the friend that he/she must stop using such a nickname. Scenario 5: "Your friend uses your textbook without permission." In this scenario, the student's friend has borrowed his/her textbook without permission. The student conveys to his/her friend either that he/she does not want to lend his/her textbook or that the friend should at least ask before borrowing it. Scenario 6: "Your funny-face picture was uploaded to a friend's blog without your permission." In this scenario, a photo taken of the student being silly and making a funny face is uploaded on a friend's blog without permission. The student conveys that he/she must remove the photo. Scenario 7: "An e-mail in which you spoke ill of others was sent to other classmates without your permission." In this scenario, the student sent an e-mail to one of his/her friends, and the friend then forwarded it without permission. The student asks the reason why and conveys that it is unacceptable.

The students wrote down responses to these scenarios freely. Responses thought to achieve a win-win situation were classified as correct answers, while all other responses were classified as incorrect answers. The number of correct answers in all the responses for each scenario was calculated as the correct answer ratio.

### **Correct Answer Ratios**

Regarding the scenarios with a high correct answer ratio, the scenario with the highest correct answer ratio was scenario 1 (Your friend lends your comic book to another person) and scenario 5 (Your friend uses your textbook without permission). The correct answer ratios were 84.3% and 79.8%, respectively. As scenarios 1 and 5 had higher correct answer ratios in comparison to other scenarios, they were categorized as the high ratio group.

The following scenarios of correct answer ratios were that scenario 4 (You gain an insulting nickname by a friend) were 79.0%, scenario 2 (Your group members speak ill of a classmate) were 77.7%, and scenario 3 (You are ignored by your friend suddenly) were 69.5%. The correct answer ratio of scenario 3 was significantly lower than that of scenario 1 ( $\chi^2 = 14.8, p < .01$ ). Thus, scenario 2, 3, and 4 were categorized as the middle ratio group.

The scenarios with the lowest correct answer ratios were scenario 6 (Your funny-face picture was uploaded to a friend's blog without your permission) and scenario 7 (An e-mail in which you spoke ill of others was simultaneously sent to other classmates without your permission). The correct answer ratios, which were no higher than 37.5% and 26.9%, respectively, were significantly lower compared to that of other scenarios (each scenario  $\chi^2 = 77.4, p < .01, \chi^2 = 46.8, p < .01$ ). As scenarios 6 and 7 had lower correct answer ratios in comparison to other scenarios, they were categorized as the low ratio group.

Scenarios were classified into three categories by the correct answers ratio. The major correct or incorrect answers described by students were as follows (Table 1). The following is an examination of the characteristics of each scenario in the high, middle, and low ratio groups.



**Table 1** Situation of each scenarios, correct answers ratio, and examples of correct and incorrect answers

Group	No. Situation	Correct answers ratio (%)	Correct answers written by students	Incorrect answers written by students
High ratio	1 Your friend lends your comic book to another person.	84.3	Can you give it back to me as soon as your brother's finished reading it?"	Give it back to me immediately!"
	5 Your friend uses your textbook without your permission.	79.8	I was surprised when you used my textbook, so next time could you tell me before using it?"	Don't do that"
Middle ratio	4 You gain an insulting nickname by a friend.	79.0	I really want you to stop calling me that because I find it offensive. How would you feel if I called you that?"	If you're going to call me that, then I'll call you..."
	2 Your group members speak ill of a classmate.	77.7	Maybe you're right, but shall we talk about something more interesting?"	say nothing
	3 You are ignored by your friend suddenly.	69.5	Are you trying to avoid me? Is there something I'm doing wrong? Please tell me."	Stop ignoring me."
Low ratio	6 Your funny face picture was uploaded to a friend's bbg without your permission.	37.5	Why did you upload my photo to your bbg without permission? You should have asked me first"	What the hell do you think you're doing?"
	7 An e-mail in which you spoke ill of others was sent to other classmates without your permission.	26.9	I was also wrong to have sent such a nasty e-mail but you shouldn't have forwarded it"	Sorry."

Correct and incorrect answers" mean the examples described by students in the program. Each scenarios was classified into three categories depending on correct answer's ratio.

## Characteristics of the Correct Answer Ratios and the Students' Written Responses

### *Characteristics of the Scenarios in the High Ratio Group*

In the characteristics of the scenarios in the high ratio group and, specifically, in scenario 1 (Your friend lends your comic book to another person), the example of a correct answer written by students (hereunder correct answers) was "Can you give it back to me as soon as your brother's finished reading it?" The examples of incorrect answers (hereunder incorrect answers) were "Give it back to me immediately!" and "Don't lend things you've borrowed without permission." The correct answer conveys both the need for the comic to be returned soon and the expected time it should be returned. The incorrect answers aggressively convey the need for the comic to be returned and merely blame the classmate. Some students felt anger toward the friend who lent someone else the comic book without asking permission. However, many

students saw that they were not harmed in any major way by such an act and thus found nothing to get upset about, provided the comic book was returned. Such students managed to remain calm and write down the correct answer.

For scenario 5 (Your friend uses your textbook without permission), the correct answers were “I was surprised when you used my textbook, so next time could you tell me before using it?” and “You’d be upset if someone used your textbook without permission, right? So, next time, can you ask me first?” The incorrect answers were “Don’t do that.” and “Why didn’t you ask? Don’t you have any common sense?” The correct answers expressed what the students wanted their classmate to do next time. In many of the incorrect answers, however, the classmate was blamed. What was characteristic about this scenario were the students who did not mind their textbook being used without permission. These students could calmly convey what they wanted the classmate to do next time, and so it was easy to provide the correct answer. The students who did mind were upset and, consequently, provided an angry answer; still, the hurt feelings could be managed if the other person’s behavior improved. From these findings, the characteristics of the high ratio group are that the other’s action may change, the problem may improve, and the problem is limited to the object, so that damage is limited to students themselves, and aggression may not be out of temper. As the characters in scenarios are limited to two persons, the situation is simple.

### ***Characteristics of the Scenarios in the Middle Ratio Group***

Concerning the characteristics of the scenarios in the middle ratio group, which had a correct answer ratio of 60%–70%, and specifically in scenario 4 (You gain an insulting nickname by a friend), the correct answer was “I really want you to stop calling me that because I find it offensive. How would you feel if I called you that?” The incorrect answers were “Stop calling me that.” and “If you’re going to call me that, then I’ll call you....” The correct answer, which makes it clear that the student finds the nickname very offensive, encourages the classmate to empathize with the situation, while the incorrect answers aggressively conveyed the student’s offense at the nickname and gave him/her an insulting nickname in return. Because the sense of damage from an insulting nickname varies between individuals, some could respond calmly while others could not. This scenario has the characteristics of a simple situation because the characters in scenarios are limited to two persons.

For scenario 2 (Your group members speak ill of a classmate), the correct answers were “Maybe you’re right, but shall we talk about something more interesting?” and “You shouldn’t say that. How would you feel if someone said that about you?” The incorrect answers were “Stop it.” and “I won’t say anything.” Students who considered it morally important to stop the group members’ speaking ill of a classmate and felt inclined to speak up gave rather aggressive responses. On the other hand, the responses

also revealed that there were some students who remained silent, letting the remark pass, and others who felt it safest to go along with the flow of the group. The characters in scenarios are three or more, so the situation becomes somewhat complex.

For scenario 3 (You are ignored by your friend suddenly), the correct answers were “Are you trying to avoid me? Is there something I’m doing wrong? Please tell me.” and “Why have you been ignoring me? If I’m doing something wrong, I’ll try and correct it.” The incorrect answers were “Stop ignoring me.” and “I’ll ignore you back.” Although the situation is simple because the characters consist of two persons, to be ignored suddenly shocks students and causes a considerable sense of damage. Regarding the middle ratio group’s characteristics, these findings suggest that in scenarios with two or more characters, the situation becomes complex, and the target that suffers damage is not limited to an object, such as the relationship between friends.

### ***Characteristics of the Scenarios in the Low Ratio Group***

The correct answers for scenario 6 (Your funny-face picture was uploaded to a friend’s blog without your permission) were “Why did you upload my photo to your blog without permission? You should have asked me first.” and “I made that silly face because I was among friends. How would you like it if someone uploaded your photo without permission? I want you to remove it.” The incorrect answers were “What the hell do you think you’re doing?” and “Get rid of it at once!” In the correct answers, the student asks why the friend behaved in such a way and conveys what the friend should do from now on. Many incorrect answers, on the other hand, exemplify the student merely blaming the friend. Uploading someone’s funny-face picture may give anyone who views the photo a negative impression of that person, which can invoke a considerable sense of damage. As a result, it is much easier to adopt an approach where one simply vents anger by blaming the person.

For scenario 7 (An e-mail in which you spoke ill of others was sent to other classmates without your permission), the correct answers were “I was also wrong to have sent such a nasty e-mail, but you shouldn’t have forwarded it.” and “I know I shouldn’t have sent that nasty e-mail, but you should not have forwarded it.” The incorrect examples were “Don’t do that.” and “Sorry.” In the correct answers, the student acknowledges his/her own fault while also conveying his/her disapproval at the friend’s behavior. The incorrect answers blamed the friend or acknowledged personal fault and apologized. Many of the responses involved merely apologizing probably because the students felt at fault as well for writing the negative e-mail, and so they had no other recourse but to apologize. When a student writes something negative about someone, and it is discovered by a third party without his/her permission, the sense of damage is considerable. From these findings, the low ratio group’s characteristics comprise a complex situation in which many persons are involved. Because the

problem may not be resolved, students experience great shock and a considerable sense of damage.

## **Conclusion**

### ***Characteristics of High, Middle, and Low Ratio Scenarios***

As illustrated in the scenarios of the high ratio groups, when the problem may be resolved, and the situation is limited to two persons, students have time to assess the situation calmly and consider a response that can achieve the desired win-win, which would benefit both parties. As illustrated in the scenarios of the middle ratio groups, the situation becomes complex, and the suffered target is not limited to an object, but the relationship instead. Students find it difficult to think of a win-win resolution. As illustrated in the scenarios of the low ratio groups, in complex situations, many persons are involve, and the difficulties in problem solving evoke anger because students want to defend themselves. As a result, the feeling of anger spirals out of control, students become more upset, and it becomes harder to reach a win-win. The results of this study suggest that damage to one's self invokes a strong sense of anger, makes it hard to suppress aggressive feelings toward the perpetrator, and increases the student's emotional turbulence.

### ***Implications for Effective Learning Materials for Psychological Education***

In order for students to realize the program's objectives and to teach students the skills they can use in real life, it is important that the program's materials have clear objectives that students can easily understand. The low ratio scenarios include situations that are hard to deal with or that evoke a feeling of anger. These scenarios are better suited for the exercise scenario applicable to daily life. However, when using scenarios with an extremely low correct answer ratio, it is necessary to give careful support, for example, to teach students strategies to resolve conflicts and regain composure, to make time for discussion.

As the complexity of situations makes it difficult for students to learn key points of the win-win, scenarios with a low correct answers ratio are inappropriate when introducing the program. On the other hand, Scenarios for which many students can provide correct answers, such as those in the high ratio group, may be considered easy scenarios. So, scenarios with a high correct answer ratio are considered appropriate for teaching students win-win responses, they should be used when introducing the program.

Toda and Watanabe's (2012) findings on the relationship between sense of damage and anger showed that during the stage of the first grade of junior high school, when students suffer damage in ambiguous conditions in which they cannot understand the

other party's intentions, they often assume the other party harbors hostile feelings, and negative feelings are easily stirred up. Crick and Dodge (1994) developed the Social Information Processing Model (hereunder SIP) in which six steps determine how people in interpersonal interaction settings perceive and judge information and their subsequent behavior: (1) taking in information (encoding of cues), (2) making sense of this information (interpretation of cues), (3) clarification of goals, (4) response search, (5) response decision, and (6) behavioral enactment. In presenting the scenarios in which students easily produce the win-win response, it is also essential to have in place strategies that reduce ambiguities that affect "encoding of cues" and "interpretation of cues," to clarify the behavior of the other party and to prevent an unnecessary sense of damage or resentment in the student who responds.

During the "clarification of goals," the student will clarify whether he/she should maintain a positive relationship with the other party or prioritize his/her profit as the situation currently stands. If the student wishes to maintain a positive relationship with the other party, he/she may still feel anger; however, he/she will be mindful of avoiding an aggressive response. Therefore, when presenting these scenarios, it is essential to relate them to "the clarification of goals," clearly depict how the character in the scenario relates to the student, and thereby reduce the student's confusion due to ambiguities.

The above findings suggest that in order for students to be given scenarios for which they can easily identify the program's objectives, it is crucial to have strategies in place, depending on the situation. For example, during the introductory stage, it is a good idea to use simplified scenarios. To clarify the behavioral intentions of the other party in the scenario and to describe the relationship between the other party and the student is ideal. On the other hand, for students to learn skills that can be used in daily life, it is important that scenarios include considerable damage to self. When using these scenarios, it is necessary for students to adopt a strategy to reduce their aggressive feelings, such as pausing for a moment to regain composure. Future studies should examine whether using scenarios in which simple situations are described in detail result in any difference in the students' comprehension; they should also examine whether students will be able to apply learned skills to their real lives by using scenarios in which the situation is complex and difficult.

## References

- Crick, R., and Dodge, K. (1994). A review and reformulation of social information-processing mechanisms in children's social adjustment, *Psychological Bulletin*, 115, 74-101.
- Harada, E. (2012). The Needs survey on the social skills training for high school students. *Memoirs of Tokyo Management College*, 20, 93-107.



- Heydenberk, R., Heydenberk, W., and Tzenova, V. (2006). Conflict resolution and bully prevention: skills for school success. *Conflict Resolution Quarterly*, 24, 55-69.
- Littlefield, L., Love, A., Peck, C., and Wertheim, E. (1993). A model for resolving conflict: Some theoretical, empirical and practical implications. *Australian Psychologist*, 28, 80-85.
- Nakane, Y., Ito, A., and Suzuki, M. (2010). Attempt to develop a psychological program that promotes preventive support for all students (2) Developing learning scenarios that meet students' needs – *The Association of Japanese Clinical Psychology 29<sup>th</sup> Annual Conference Report*, p.472.
- Nakasato, S., Kubota, Y., and Hasegawa, H. (2011). Effect of information morality study of cyber-bullying: relation between morality study and possession of cellular phone, *Japan Journal of Educational Technology*, 35, 121-124.
- NTT Docomo (2004). Safety program of mobile phone. <<http://www.nttdocomo.co.jp/corporate/csr/social/educational/safety/>> (2013.4.1)
- Okada, S., Goto, H., and Ueno, K. (2005). Effect of social skills training including rehearsal of game activities: Comparison of children with LD, ADHD, and Asperger syndrome. *Japanese Association of Educational Psychology*. 53, 565-578.
- Patchin, J., and Hinduja, S. (2006). Bullies move beyond the schoolyard; A preliminary look at cyberbullying. *Youth Violence and Juvenile Justice*, 4, 148-169.
- Shigeyoshi, N., and Otsuka, Y. (2010). Effects of anger control program for junior high school students Hiroshima. *Psychological Research*, 10, 273-287.
- The Ministry of Education, Culture, Sports, Science and Technology (2012). On “Research related to issues on instructing students such as school children’s problematic behaviors” <[http://www.mext.go.jp/b\\_menu/houdou/24/11/\\_icsFiles/afieldfile/2012/12/09/1328532\\_01\\_1.pdf](http://www.mext.go.jp/b_menu/houdou/24/11/_icsFiles/afieldfile/2012/12/09/1328532_01_1.pdf)> (2013.4.1)
- Toda, M., and Watanabe, K. (2012). Social information processing and development of interpretative and reactive behavior toward ambiguous attacks. *The Japanese Journal of Developmental Psychology*, 23, 214-223.
- Tsuda, A., Katsuma, L., and Yamasaki, K. (2011). School-based universal prevention education for bullying: Development of educational methods and practices. *Bulletin of Center for Collaboration in Community Naruto University of Education*, 26, 9-17.
- Watanabe, Y., Harada, E., and Saito, A. (2009). Social skill education approached emotion. *The Annual report of educational psychology in Japan*, 48, 42-43.



*Validation of Psychological Capital Questionnaire in Thai Employees*

Siriporn Sapyaprapa, Arunya Tuicomepee, Rewadee Watakakosol

Chulalongkorn University, Thailand

0328

The Asian Conference on Psychology & the Behavioral Sciences 2013

Official Conference Proceedings 2013

Abstract

Although the construct of psychological capital was first introduced by Luthan, its concept has been developed in attaining competitive advantage and supporting unity between employee and organization within a western context. Study in this topic is much less attention in Asia, especially in Thailand. This current study therefore aimed to develop and initial validate a Psychological Capital Questionnaire (PCQ) in Thai employees. The original PCQ consisted of 4 components (i.e., self-efficacy, optimism, hope, and resilience) with 24 items in total. The new version of PCQ developed for this current study contained 60 items. Participants were 120 Thai employees from various private organizations in Bangkok Metropolis. They were recruited by convenience sampling method. Corrected item-total correlation (CITC), Internal consistency reliability (Alpha coefficient), and Confirmatory Factor Analysis (CFA) were used to examine psychometric properties. Initially, the Principle Component Analysis (PCA) was conducted with 60 items of the new version of PCQ. PCA yielded four factors of the new version of PCQ with 24 items in total. CFA confirmed that the four factors of the new version of PCQ were significantly fitted the data ( $\chi^2 = 2.46$ ,  $df = 2$ ,  $p = .292$ , GFI = .990, AGFI = .949, RMSEA = .044). Alpha coefficient of the new PCQ scale was 0.95. Alpha coefficients of the four subscales of PCQ ranged from 0.80 to 0.87. This study demonstrated that the 24-item PCQ in Thai version has good psychometric properties and thus is useful instrument to assess Thai employee's psychological capital.

Keywords: Psychological Capital, Thai employees, Validation

## Introduction

Competitive advantages such as cost leadership or high value-added of goods and services help today's organization adapt, survive, and grow up under business world changes. Beyond its impact on organization economies, competitive advantages lead to workplace stress and other undesirable organizational outcomes such as job dissatisfaction, burnout, and organizational withdrawal. Recently, Luthans and colleague (2004) proposed one of the human capitals called "Psychological capital or Psycap" that has positive effects on competitive advantage of an organization. Psycap is defined as a positive state-like capacity or an individual's positive psychological state of development and is characterized by four components: (1) having confidence (Work Self-Efficacy) to take on and put in the necessary effort to succeed at challenging tasks; (2) making a positive attribution (Optimism) about recent and future success; (3) persevering toward goals and, when necessary, redirecting paths to goals (Hope) in order to succeed; and (4) when beset with problems and adversity, sustaining and bouncing back and even beyond (Resiliency) to attain success (Luthans, et al., 2007). Promoting employee's Psycap has been developed in attaining competitive advantages and supporting unity between employees and organizations. Although the construct of psychological capital was first introduced by Luthan, its concept has been developed in attaining competitive advantages and supporting unity between employees and organizations within a western context. Study on this topic is much less attention in Asia, especially in Thailand. The current study, therefore, aimed to develop and initially validate a Psychological Capital Questionnaire (PCQ) in Thai employees.

## Methodology

**Participants.** This study consists of 120 Thai employees (36 males, 84 females) with mean age 29.6 years old ( $SD = 7.17$ ). Their average work experience was 4.33 years ( $SD = 6.78$ ). Participants were recruited conveniently from various private companies in Bangkok Metropolis, Thailand during November, 2012 to January, 2013.

**Procedure.** The original 24-item PCQ (Luthans, Youssef, & Avolio, 2007) was translated into Thai language using forward translation process. Based on existing literature and original 24 items; sixty items of Thai version of PCQ were generated. The developed PCQ was reviewed by the three experts to secure the scale's content validity. Example questions of the Thai version of PCQ were "*I am confident in my performance that I can work under pressure and challenging circumstances (Work Self-efficacy)*", "*I believe that all the problems occurring at work always have a bright side (Optimism)*", "*I have several ways to accomplish the work goal (Hope)*", and "*Although too much responsibility at work make me awkward, I can go through to work successfully (Resilience)*". A simple 5-point Likert scoring system was used for each item of PCQ. Responses were scored as follows: "strongly disagree" (score of 1) to "strongly agree" (score of 5).

After receiving approval from the committee for Human Research, Chulalongkorn University, the first author contacted a coordinator of each organization to recruit participants by convenience sampling method.

**Data Analysis.** Corrected item-total correlation (CITIC), Internal consistency reliability (Alpha coefficient), and Confirmatory Factor Analysis (CFA) were used for psychometric property analyses.

## Results

The findings suggested that all 60 items of PCQ meet the selection criteria CITC value is greater than critical  $r$  value [ $r(118) = .151, \alpha = 0.5$ ]. To make the scale parsimony, an appropriate number of items were determined by the CITC scores. For each subscale, the first six items with highest CITC value were selected. The final version of PCQ contained twenty four items (6 item per subscale). The final version of the scales yielded satisfied CITC (as of 0.46 to 0.77) and internal consistency (Cronbach's alpha of .95). The Cronbach's alpha coefficients of the four subscales were as follows: Work Self-efficacy (.87); Optimism (.80); Hope (.84); and Resilience (.86) as shown in Table 1.

Table 1

*Items, Corrected Item-Total Correlations for Each Item of the 24-item PCQ Thai version*

The logo for 'iafor' is centered on the page. It consists of the lowercase letters 'iafor' in a light blue, sans-serif font. The logo is partially enclosed by a large, light blue circular arc that starts from the bottom left and curves towards the right. A smaller, pinkish-red circular arc is visible on the left side of the page, partially overlapping the blue one.

No	Item	Original-item	Developed-item	CIT C
<b>Sub scale 1: Work Self Efficacy</b> ( $\alpha = .87$ )				
1	<i>I feel confident in analyzing a long-term problem to find a solution. (+)</i>	✓		0.59
2	<i>I feel confident contacting people outside the company (e.g., suppliers, customers) to discuss problems. (+)</i>	✓		0.59
3	<i>Although supervisor assigns me an extra job which I never had done it, I still believe in my ability that I can do it. (+)</i>		✓	0.66
4	<i>I am confident in my performance that I can work under pressure and challenging circumstances. (+)</i>		✓	0.75
5	<i>I feel confident that I can accomplish my work goals. (+)</i>		✓	0.77
6	<i>If organizations transform new working system which is difficult to understand, I am still confident that I can learn new things from this system. (+)</i>		✓	0.65
<b>Sub scale 2: Optimism</b> ( $\alpha = .80$ )				
7	<i>I'm optimistic about what will happen to me in the future as it pertains to work. (+)</i>	✓		0.46
8	<i>At work, I always find that every problem has a solution. (+)</i>		✓	0.66
9	<i>I believe that all the problems occurring at work always have a bright side. (+)</i>		✓	0.65
10	<i>If I have to face with bad situation, I believe that everything will change to be better. (+)</i>		✓	0.56
11	<i>I believe that success in the current work will occur in the future. (+)</i>		✓	0.52
12	<i>I always stuck with the problem and found that the problem cannot do anything. (-)</i>		✓	0.49
<b>Sub scale 3: Hope</b> ( $\alpha = .84$ )				
13	<i>At the present time, I am energetically pursuing my work goals. (+)</i>	✓		0.62
14	<i>I have several ways to accomplish the work goal. (+)</i>		✓	0.51
15	<i>When I found that my performance appraisal was less than the expected goal, I am trying to find the ways to improve, and then start to do better. (+)</i>		✓	0.54
16	<i>Now, I feel that I am energetic to accomplish the work goal. (+)</i>		✓	0.65
17	<i>When I set goals and plan to work, I will be concentrated to achieve the goal. (+)</i>		✓	0.68
18	<i>I work as the goals set by the belief that "Where there is a will, there is a way". (+)</i>		✓	0.71
<b>Sub scale 4: Resilience</b> ( $\alpha = .87$ )				
19	<i>I usually manage difficulties one way or another at work. (+)</i>	✓		0.65

No	Item	Original-item	Developed-item	CITC
20	<i>I usually take stressful things at work in stride. (+)</i>	✓		0.64
21	<i>Although my work is failed, I will try to make it success again. (+)</i>		✓	0.62
22	<i>Although too much responsibility at work makes me feel awkward, I can go through to work successfully. (+)</i>		✓	0.67
23	<i>I am undiscouraged and ready to face with difficulties at work. (+)</i>		✓	0.77
24	<i>When I faced with disappointment at work, "I fell but I could quickly get through". (+)</i>		✓	0.60
<b>The 24-item PCQ ( <math>\alpha = .95</math> )</b>				

A confirmatory factor analysis (CFA) was further conducted, and the result suggested that the measurement model of three scales fit the data very well ( $\chi^2 = 2.465$ ,  $df = 2$ ,  $p = .292$ ,  $GFI = .990$ ,  $AGFI = .949$ ,  $RMSEA = .044$ ) (Figure 1).

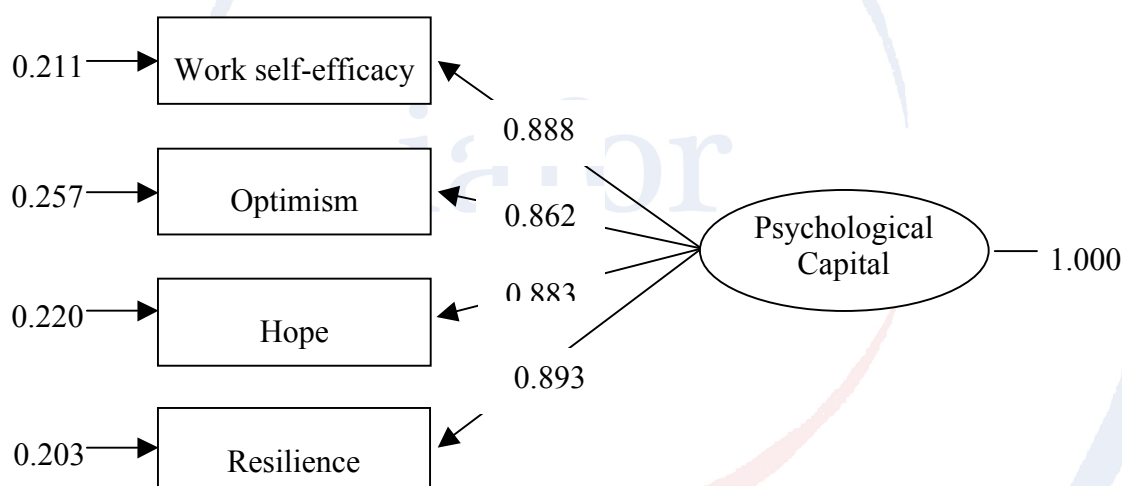

$\chi^2 = 2.465$ ,  $df = 2$ ,  $p = .292$ ,  $RMSEA = .044$ ,  $GFI = .990$ ,  $AGFI = .949$

Figure 1  
 Confirmatory factor analysis model of the developed 24-PCQ Thai version.

### Discussions & Conclusion

The objective of this research project was to develop and validate a measure of Psychological Capital in Thai employees. Corrected item-total correlation (CITC) and Internal consistency reliability (Alpha coefficient) were conducted. The Alpha coefficient of new 24-item PCQ was high (0.95) and the Alpha coefficient of its subscales were ranged from .80 to .87; Work Self-efficacy (.87); Optimism (.80); Hope (.84); and Resilience (.86). The findings indicated that the new 24-item PCQ was a reliable scale. This result was consistent with Luthan and colleagues's research which showed high reliability values of Psychological Capital Questionnaire. (Luthan et al., 2007). Moreover, the construct validity of the 24-PCQ testing by CFA

confirmed that the 4-factor of PCQ model fitted in the data. The current study's finding suggests that the new 24-item PCQ in Thai version contains four factors and has good psychometric properties to assess employees' psychological capital. This finding was consistent with a previous study (e.g. Luthan, Avey, & Norman, 2007). As the current study focused on participants who were private employees only, future study should extend the development of PCQ into other contexts such as public company, non-profit organization, or school. In summation, a Thai version of 24-item PCQ demonstrates satisfied reliability and valid to use in Thai employees.

### References

- Hair, J. F., Black, W. C., Babin, B. J., Anderson, R. E., & Tatham, R. L. (2006). *Multivariate data analysis* (6<sup>th</sup> ed.). Upper Saddle River, NJ: Prentice-Hall.
- Luthans, F., Avey, J. B., & Norman, S. M. (2007). Positive psychological capital: measurement and relationship with performance and satisfaction. *Personnel Psychology*, *60*, 541-572.
- Luthans, F., Luthans, K. W., & Luthans, B. C. (2004). Positive psychological capital: beyond human and social capital. *Business Horizons*, *47*, 45-50.
- Luthans, F., Youssef, C. M., & Avolio, B. J. (2007). *Psychological capital developing the human competitive edge*. New York: Oxford University Press.

iafor



*Negligence in a Modern Families Lives*

Roswiyani Roswiyani

Tarumanagara University, Indonesia

0345

The Asian Conference on Psychology & the Behavioral Sciences 2013

Official Conference Proceedings 2013

Abstract

Modern invention on telecommunication devices has reduced the distance between people in the world. People can make contact between one another within seconds, and the cost of communication is very minimal even free if conducted between the same providers. Ironically such condition has a reverse impact on the interpersonal relations between some family members since each individual in the family tends to be preoccupied having contact with others while neglecting their own family communication, or they keep themselves busy sending text messages while having a family gathering. The act of texting has become problematic in official meetings; individuals would rather pay more attention on their personal matters by texting. This has become a form of the act of negligence in interpersonal communication and is considered as impolite or inappropriate. While families need to maintain interpersonal communication by having activities such as family dining or family gathering in a limited time frame, the act of texting during such activities may increase feelings of interpersonal distance among family members resulting in the sense of alienation between the members. This paper will present case studies where such act of negligence has created more gaps between family members resulting in the sense of alienation that destroys family bonding.

Keywords: Negligence, Alienation, Modern communication, Interpersonal relation, family bonding.

## Introduction

Recently people need to have instantaneous communication by using more complex instruments. They are not using natural instruments such as voice, body language, or facial expression, but also utilizing modern technology such as mobile phones, smart phones and internet (Caplan, 2003). The development of telecommunication devices has opened more opportunities for people to get connected across areas immediately, and to get responses from others instantaneously with low cost (Heeks & Jagun, 2007). Decades ago people need excessive amount of time to communicate across places by mailing letters through the postal system or at least by going to a telephone booth with a number of coins. Recently people mail letters through the internet and can immediately make a phone call by using hand phones without having to go to a telephone booth (Wang & Andersen, 2007).

The telecommunication industries have been developed extensively and significantly since the beginning of 1980 (Locke & Strickling, 2010). Hand phone technology is developed rapidly in the world (Rebello, 2010). In the year of 2001, hand phone users were around five billion with the greatest number of users in the developing countries rather in the advanced countries (Kelly, 2009; Rebello, 2010). Individual needs to use such communication devices are increased when the features in the devices are perfected such as to save dates, videos, photos, and internet connection. As a result hand phones become an important instrument for a person to obtain information, promotion, business and to have social communication through internet (Locke & Strickling, 2010). Such facilities have created more possibilities for people to keep in touch and to be together with others although in an illusory world.

Recently hand phones have been utilized for various purposes besides merely for communication. In a number of countries and places the people, primarily youths, create their unique subcultures through hand phones by using SMS (short message service) or texting, or by using e-mail through hand phones (Ishii, 2006). The SMS facilities support people to maintain their communication between one another in the society, in order to not feel lonely although they were physically alone (Manghani, 2009). According to Manghani (2009) a person uses SMS to show their emotion, idealism, and values to others. SMS is an extending instrument for a person to communicate with others to perform their emotion by a creative way. The hand phone itself is an instrument to reduce distances between people which potentially help people to deal with feelings of loneliness.

Holtgraves (2010) mentioned that a person uses SMS in order to feel with others while being alone. SMS is considerably efficient to be utilized for sending short and direct messages. This is associated with keeping the relationship with others. Aside from that, according to Pettigrew (2009) people use SMS not only to maintain interpersonal relationships, but also to influence intimacy to remain close to others. SMS is a form of direct communication that is also personal and facilitates interpersonal relations and simultaneously maintains independency.

There are abundant reasons that SMS may increase the quantity and the quality of interpersonal communication. SMS allows individuals to maintain communication in distant places. SMS increases self disclosure. SMS allows foreign or unknown person to ask direct questions and to get direct responses as well as increases interpersonal attraction (Barnes, 2003).

Family members are expected to have good communication. Good communication between the members in the family can create strong familial bonding (DeVito, 2013). Strong family bonding will support the members to become healthier, and having better social interaction. However, the existence of modern technology, particularly SMS in hand phone or smart phone can change the communication pattern between family members (Rhee & Kim, 2004). Hand phones allow parents and children to keep connected in an emergency situation, or during daily conversations. However in South Korea, such communication modes create conflicts in the family primarily parents and children (Rhee & Kim, 2004). Research in the US on male and female children to adolescents (age 10-17) who have close relations in the illusory world through telecommunication modes tend to have communication problems with their parents and tend to have problems in the society. The case is not so among those who do not have friends in the illusory world (Wolak, Mitchell, & Finkelhor, 2003). The excessive use of telecommunication modes makes people have a lack of face to face communication with friends and families (Bower, 1998; Nie, 2001), and such condition will influence a person to experience loneliness (Moody 2001). When a person changes the face to face communication with illusory communication, the quality of communication with the environment will be disturbed (Adler, Rosenfeld, & Proctor II, 2010).

Currently there are researches on the impact of communication modes on friendship interaction (Kraut et al., 1998 in Ishii, 2006). The result indicates that a person's social ability will be reduced after he or she uses more internet or SMS modes. However, LaRose, Eastin and Gress (2001) explained that such modes also have the power to reduce depression due to the existence of social support by internet or SMS (Ishii, 2006). Therefore, the development of technology on hand phones may provide efficient and cheap modes of communication, yet at the same time they may also create problems due to inappropriate use of the instrument while being with others. In a number of cases people use the devices while being with others or while in a family gathering when face to face communication is ongoing. Other persons may feel neglected when a person who is supposed to communicate with them is busy texting. People will feel neglected and unexpected to have conversation with someone who is busy texting. In a family, when members are busy texting, the others may feel neglected and even alienated. Such conditions will gradually create emotional distance between family members (Ishii, 2006).

Success in developing family life depends on the family members' interpersonal communication. In a survey on 1001 adolescent respondents (age 18), 53% claimed that lack of effective communication is the primary source of marital failure (DeVito, 2013). Therefore, internal communication within the family is very important, whereas lack of communication will create interpersonal conflict associated with lack

of love and care, lack of time to get together, problems of trust, and members in the family creating more distances (DeVito, 2013).

## Methods

The two cases below are obtained voluntarily. Family history, life history and personal communication are used to collect data. Qualitative analysis is utilized based on in-depth interview, observation, and personal historical data.

## The Cases

There was a mother (N), 34 years of age who has 2 sons of 6 and 4 years old. Both children have limitations on physical and mental development. N babysits her own children without any help. N regularly takes care of her children by utilizing hand phones. She turned on the music on the hand phone and gave the hand phone to the children to allow the children to play by themselves; in the meantime N kept herself busy texting with others. The older son frequently yells “mamma”, and N changed the music on the hand phone. N also gave a toy car that produces music to the second son, so that they both played independently, meanwhile N remained busy texting.

One day, the older one was having cough. N gave him a generic cough syrup and did not take him to a doctor. Sometimes the child whispered in pain followed by yelling “mamma”, asking to be hugged and to get attention from his mother. However, N considered that the illness was just a common flu, and N remained busy with her hand phones. N took her son to travel to a mountain area for vacation even though his condition was seemingly weak. On return from vacation the child requested to be hugged by N, and N did it for only a few minutes while her hands remained busy texting. The following day the child’s body was getting colder, he was taken to the hospital, but it was too late. He died in the hospital. N remained silent and kept busy texting. This is an example of how a person utilizes the communication modes inappropriately, she became addicted on texting and she neglected her child resulting in the death of the child. Indeed the instrument is not the thing to blame but the person who uses the instrument is.

Another case is a 55-year-old mother (D) who has 4 children. She has financial problems thus needs to ask help from others to get financial support. For such reason, she is busy using her mobile phone either to make or receive phone calls or to do texting. The family members become second to the mobile phone. She rarely communicates to show her concern over her children’s activities. Her husband who has already been retired tends to feel lonely due to lack of communication with his wife. Her financial pressure creates stress as well as resulting in sensitive responses during conversations with her family members, and this easily triggers conflict in the family since she easily outbursts.

At present she remains having problems with family communication, yet she also remains addicted with her telecommunication activities. Most of the time when she starts to communicate with the family members, personal conflicts begin.

## **Conclusion & Discussion**

Prior to the modern life conditions, family members may have lack of communication associated with limited communication access. Yet when communication access is considerably improved in a modern life it does not solve the problem of limitation of communication access. Ironically the modern communication devices potentially influence the family communication in a rather negative direction.

The existence of the internet and mobile phone that supposedly help people get closer by keeping close contact has counterproductively created more distant relationship between family members. Being addicted with modern communication mode of instruments is potentially creating the attitude of negligence regarding the presence of other people and family members. Negligence is a form of abuse in some way, and impolite as well as inappropriate manner in another way. Although all behavior is determined by the person and not by the instrument, the attractiveness of the instruments may potentially threaten human interpersonal relationships.

One needs to take precautions in utilizing the devices, yet people tend to lose their behavior and emotional control once they are attracted to an object that can provide interesting facilities. It is indeed human nature to get attracted by facilities that may fulfill their personal needs, yet they also need to be aware that they live in the society along with their friends and families. They may use the facilities to avoid loneliness by keeping in touch with others in an illusory world, yet neglecting the real presence of others. Such condition will create possibility that they gradually become lonely and alienated in the family. Or perhaps, they have really been alienated prior to having the modern modes of communication, thus when the modes exist they prefer to get closer with the modes than to their families.

Further research and considerations are necessary to explore that may be such people initially were lonely and alienated thus are easily attracted by the devices, or they initially were attracted by the devices resulting in being alienated in the family. It may be both. It may be that basically many people are feeling alienated in the society, and they get confused in directing themselves to socialize. They may have been alienated in a modern life, or perhaps modern life has created potentials for people to get more alienated from the society.

## **References**

Adler, R. B., Rosenfeld, L. B., & Proctor II, R. F. (2010). *Interplay: The process of interpersonal communication*. NY: Oxford University.

Chung, D. (2003, May). I am not a lonely person any more: Interpersonal relationships in computer-mediated-communication. Paper presented at the International Communication Association, San Diego, CA.

DeVito, J. A. (2013). *The interpersonal communication book* (13th ed). Boston: Pearson.

Ishii, K. (2006). Implications of mobility: The uses of personal communication media in everyday life. *Journal of Communication* 56 (2006) 346–365, International Communication Association.

Kelly, T. (2009, May). Mobile 2.0 beyond voice? Research agenda. Keynote address at International Communication Association preconference, Chicago, IL.

Manghani, S. (2009). Love messaging: Mobile phone texting seen through the lens of Tanka poetry. *Theory, Culture, & Society*, 26, 209-232.

Holtgraves, T. (2010). Text messaging, personality, and the social context. *Journal of Research in Personality*, 45, 92-99.

Pettigrew, J. (2009). Text messaging and connectedness within close interpersonal relationships. *Marriage and Family Review*, 45, 697-716.

Rebello, J. (2010). Global wireless subscriptions reach 5 billion. Retrieved from <http://www.isuppli.com/Mobile-and-Wireless-Communications/News/Pages/Global-Wireless-Subscriptions-Reach-5-Billion.aspx>

Tidwell, L. C. & Walther, J. B. (2002). Computer-mediated communication effects on disclosure, impressions, and interpersonal evaluations: Getting to know one another a bit at a time. *Human Communication Research*, 28(3), 317–348.

Wang, H., & Andersen, P. A., (2007, May). Computer-mediated communication in relationship maintenance: An examination of self-disclosure in long-distance friendships. Paper presented at the annual meeting of the International Communication Association, San Francisco, CA.



*Explaining Context Effects through the Perspective of Preference Uncertainty*

Jih-Jeng Huang

Soochow University, Taiwan

0359

The Asian Conference on Psychology & the Behavioral Sciences 2013

Official Conference Proceedings 2013

Abstract

Context effects have received much attention by marketers to understand consumer's purchasing behavior. Recently, many behavioral models have also been proposed to capture context effects so that marketers can utilize these models to determine marketing strategies. However, conventional behavioral models, which only consider the values of product attributes, may lose important information to account for context effects. In this paper, we examined the relationship between preference (un)certainty and context effects so that we can extend the consideration of behavioral models.

Keywords: Behavioral model; preference uncertainty; marketing strategies; context effects.

## 1. Introduction

Context effects indicate that when evaluating a set of choices, consumers consider the alternatives not only in isolation, but also in relation to other possible options (Highhouse 1996; Herne 1999). This is in contrast to traditional economics, which postulates consumers' choice behavior should meet the principle of regularity or irrelevance of independent alternatives (IIA) (Luce 1959; Luce 1977).

To capture the behavior of consumer choice by considering context effects, many theoretical models have been proposed, such as elimination by aspects (EBA) (Tversky, 1972a, 1972b; Tversky and Sattath, 1979), componential context model (Tversky and Simonson, 1993) and decision field theory (Roe et al., 2001; Busemeyer and Townsend, 1993). It should be noted that a behavioral model is very useful for marketers to realize, predict, and explain consumer choice behavior in proposing competitive strategies for positioning, targeting, and branding (Kivetz et al. 2004<sup>a</sup>; Lehmann and Pan 1994; Kivetz et al. 2004<sup>b</sup>; Wernerfelt 1995; Sheng et al. 2005).

Although Busemeyer et al. (2006) suggested that all context effects provide benchmarks that any model of decision making must strive to explain, so far no behavioral model is proposed to account for all context effects. However, an interesting problem thus arises as to whether we should propose a "perfect model" which accounts for context effects as much as possible or understand when and how to use these existing behavioral models?

Therefore, the purposes of this paper are twofold: first, we examine the relationship between context effects and the preference uncertainty of a consumer to explain the salient condition of a specific context effect. This is because some context effect, such as the compromise effect and the attraction effect, have been reported that they are salient when the preference of a consumer is uncertain (Simonson 1989; Kahneman et al. 1991; Tversky and Kahneman 1991). However, no empirical study has been proposed to support the above statement. In addition, we still do not if all context effects are related to the preference of a consumer. Secondly, we can propose the further direction of a behavioral model which account for context effects.

## 2. Context Effects

Context effects can be considered as the extent to which a consumer's preference toward an option is influenced by other options in a choice set. In this section, four context effects, namely, the attraction, compromise, similarity, and extremeness seeking effects, are introduced as follows. In addition, to demonstrate the phenomena of the context effects, consider a choice set  $\{A, B, C, D, E\}$ , where options A, B, C, and E are non-dominated and Option D is dominated only by Option B, as shown in Figure 1.

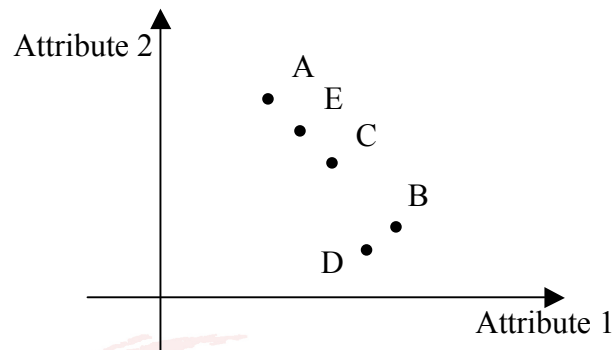

**Figure 1. Options in the choice set**

The chosen probability of an option under a specific choice set can be defined as  $P(\text{option}|\{\text{choice set}\})$ . For example, if we want to represent the chosen probability of Option A under the choice set  $\{A,B,C\}$ , then we can express as  $P(A|\{A,B,C\})$ .

### 2.1 Attraction Effect

The attraction effect can be explained by considering the choice set  $\{A,B\}$  where Options A and B are non-dominated. That is,  $P(A|\{A,B\}) = P(B|\{A,B\})$ . By introducing Option D into the choice set, i.e.,  $\{A,B,D\}$ , the attraction effect indicates that  $P(A|\{A,B,D\}) < P(B|\{A,B,D\})$ . Clearly, there is a psychological bias of consumer choice here since Option D is a decoy which is dominated by Option B and should not change the result of the original choice set.

Explanations of the attraction effect can be categorized as extremeness aversion (Tversky and Simonson 1993; Simonson and Tversky 1992), “justifiability” (Simonson 1989), perceptual biases (Huber et al. 1982; Huber and Puto 1983), and context-dependent weighting (Huber, Payne and Puto 1982, Tversky, Sattath and Slovic 1988). The attraction effect definitely violates the principle of regularity, which states that the probability of choosing an option cannot be increased by enlarging the choice set.

### 2.2 Compromise Effect

The compromise effect describes the phenomenon how the share of an alternative is increased when it is the intermediate option in a choice set (Simonson 1989, Tversky and Simonson 1993). The compromise effect can be explained by extremeness aversion (Tversky and Simonson 1993) and reason-based choice (Simonson 1989). Extremeness aversion can be considered as the situation where extreme alternatives in a choice set are ranked lower than those with moderate values (Tversky and Simonson 1993). On the other hand, the concept of reason-based choice assumes that consumers expect their decisions to be evaluated by others, and thus compromise alternatives seem to be easier to justify to oneself and to others (Simonson 1989).

To demonstrate the compromise effect, we can consider the choice sets  $\{A,B\}$ ,  $\{A,C\}$ ,  $\{B,C\}$ , and  $\{A,B,C\}$ , where Options A, B, and C are non-dominated, as shown in Figure 1. If  $P(A|\{A,B\}) = P(B|\{A,B\})$ ,  $P(A|\{A,C\}) = P(C|\{A,C\})$ ,  $P(B|\{B,C\}) = P(C|\{B,C\})$ , then  $P(A|\{A,B,C\}) = P(B|\{A,B,C\}) < P(C|\{A,B,C\})$ . Therefore, the compromise effect shows significant extremeness aversion of consumers, since options A and B are viewed as extremeness options when the choice set  $\{A,B,C\}$  is considered.

Studies of the compromise effect suggest that the preference uncertainty explains why

consumers choose an intermediate alternative that combines both attributes (Simonson, 1989). The compromise effect violates the principle of IIA, which states if option A is chosen at least as often as B in a binary choice set, then option A should also be chosen at least as often as option B when a new option is added to form a triadic choice set. Therefore, many revised consumer choice models have been developed to explain it, e.g., Kivetz et al.'s loss-aversion model (2004) and Sheng et al.'s expected loss model (2005).

### *2.3 Similarity effect*

Let the choice sets be  $\{A,B\}$  and  $\{A,B,E\}$ , respectively, as shown in Figure 1. The similarity effect indicates that if  $P(A|\{A,B\}) = P(B|\{A,B\})$ , then  $P(B|\{A,B\}) = P(B|\{A,B,E\})$  and  $P(A|\{A,B\}) < P(A|\{A,B,E\})$  when introducing Option E which is similar to Option A but not Option B.

In contrast to the attraction and compromise effect, the similarity effect has been less discussed and acts counter to the compromise effect (Simonson 1989), since the compromise effect indicates the share of extremeness options should decrease. Thus, few behavioral models account for the similarity effect, except for EBA (Tversky 1972a 1972b; Tversky and Sattath 1979) and decision field theory (Roe, Busemeyer and Townsend 2001; Busemeyer and Townsend 1993). Therefore, it is useful for marketers to understand the distinguishing conditions between the similarity and compromise effects so that they can derive more effective marketing strategies.

### *2.4 Extremeness seeking effect*

Like the similarity effect, the extremeness-seeking effect acts counter to the compromise effect. The extremeness-seeking effect indicates that consumers may choose extreme options rather than compromise options (Gourville and Soman 2005) and several explanations have been proposed for this effect. For example, Gourville and Soman (2005) showed that when the possible options increase, consumers may choose extreme options to reduce the difficulty in making a choice. In addition, the attributes of an option are non-alignable (non-tradeoff) may lead consumers to choose extreme options (Gourville and Soman 2005). Furthermore, Chen and Rao Hill (2009) suggested that when purchasing a gift, consumers prefer extremeness options to compromise options. The extremeness-seeking effect is a newer issue than other context effects and should be explored further.

We can re-consider the choice sets  $\{A,B\}$ ,  $\{A,C\}$ ,  $\{B,C\}$ , and  $\{A,B,C\}$ , as shown in Figure 1, to demonstrate the extremeness seeking effect as follows. If  $P(A|\{A,B\}) = P(B|\{A,B\})$ ,  $P(A|\{A,C\}) = P(C|\{A,C\})$ ,  $P(B|\{B,C\}) = P(C|\{B,C\})$ , then  $P(A|\{A,B,C\}) = P(B|\{A,B,C\}) > P(C|\{A,B,C\})$ . Clearly, the extremeness-seeking effect results in a situation opposite to the compromise effect since adding an intermediate option increases the ranking of extreme options.

From the introduction of the context effects, we can see that some context effects are conflict with others when consumers consider different choice sets. However, previous studies did not fully examine the salient conditions of context effects by considering the issues of a consumer's preference uncertainty.

## **3. Level of preference uncertainty**

Ambiguity in a purchasing behavior is caused by missing information that is relevant

and that could be known by consumers in choosing products (Camerer and Weber 1992; Frisch and Baron 1988; Heath and Tversky 1991). That is, some consumers feel more ambiguity and others feel less ambiguity when making a purchasing choice. Therefore, a consumer may search all available (un)information, whether the (un)information is from options or other factors, to eliminate the discomfort feeling of ambiguity and choose seems to be the best option. In addition, the degree of ambiguity in the choice context often determines the degree of uncertainty with which a consumer holds a preference (Muthudrishnan and Kardes 2001). That means that when a consumer determines the best option from a choice set, he/she is influenced by different degrees of ambiguity and preference uncertainty.

When consumers have a high degree of preference uncertainty caused by a high degree of ambiguity about their options, they try to make trade-offs between attributes to select the optimal option (Shafir, Simonson, and Tversky 1993; Tversky and Shafir 1992). Therefore, the characteristic of loss/extremeness aversion, where in losses loom larger than the corresponding gains, affects the choice of options. This conclusion is echoed by Dhar, Nowlis, and Sherman (2000), who suggested that consumers use the process of compensatory comparisons among options to determine the best option when their preferences are uncertain, and the compromise effect is especially salient in this situation. Furthermore, Simonson (1989) also concluded that the reasons for the attraction and compromise effects may be arisen when the preferences of consumers are uncertain. According to the above statements, the hypotheses of the compromise and attraction effects can be proposed as:

- H1: The compromise effect is positively influenced by the degree of preference uncertainty.
- H2: The attraction effect is positively influenced by the degree of preference uncertainty.

On the other hand, if a consumer can easily decide which attribute/option is superior to others, i.e., there is less choice context ambiguity, he/she may give greater weight to the key attributes and tend to select extreme options. In addition, this consumer is less influenced by the context and will show more consistent choice behavior. Thus, when consumers have a higher degree of preference certainty about product attributes, they are likely to choose the best option by adopting noncompensatory decision rules, e.g., the lexicographic or Max rules (Svenson, Edland, and Slovic 1990). Recent empirical studies (Gourville and Soman, 2007; Chen and Rao Hill, 2009) have also shown that consumers may choose extreme options, i.e., the behavior of extremeness seeking, which violates the evidence of the compromise effect.

The similarity effect indicates that a consumer may change his/her mind if the added option is similar to the chosen option, but not change if the introduced option is different from the chosen option. This induction is more likely if the preference of the consumer is more certain and the reason can be understood by reconsidering the choice set {A,B} shown in Figure 1. Since the consumer is uncertain about which attribute/option is important/optimal, he/she may choose one at will or randomly, because there is no other information for reference. However, when Option E, which is similar to Option A, is incorporated into the choice set, a consumer who prefers Option B may change his/her mind to consider Option A or E. This is because if the optimal option is uncertain, the probability of choosing the right option will increase from 1/2 to 2/3 when forgoing Option B and choosing Option A or E.

Therefore, when a consumer's preference is clear, the similarity effect is more salient. This induction can be justified from the postulation of models, which explain why the similarity effect usually postulates noncompensatory decision rules, e.g., the lexicographic rule is postulated by the EBA model (Tversky 1972a, 1972b, Tversky and Sattath 1979) and strategy switching models (Gigerenzer and Selten 2001, Payne, Bettman, and Johnson 1993).

Like the similarity effect, the extremeness-seeking effect also indicates the preference certainty of a consumer. Gourville and Soman (2005) showed that options with non-alignable attributes, i.e., non-compensatory between attributes, increase the tendency of extremeness-seeking. The tendency can be explained as forcing consumers to crystallize their preferences in choosing options, instead of making trade-offs between attributes. This explanation can also be supported by the finding in Chen and Rao Hill (2009) that consumers forgo intermediate options when buying gifts.

According to the above statements, the hypotheses of the proposition here can be given as:

H3: The similarity effect is negatively influenced by the degree of preference uncertainty.

H4: The extremeness seeking effect is negatively influenced by the degree of preference uncertainty.

It is clear that consumers may use compensatory and non-compensatory decision rules simultaneously in choosing the optimal option (Baron, 2000). Therefore, in this paper we consider the compensatory and non-compensatory decision strategies as a spectrum instead of a dichotomy.

#### **4. Empirical Studies**

The first to forth study tested the relationships between preference uncertainty and context effects. A total of 90 subjects for all studies were recruited from undergraduate marketing classes and asked to answer the questions via computer to avoid group influence. The questions investigated their preference toward digital cameras and laptop computers using a six-point Likert six-point scale (1 = uncertain and 6 = certain). Finally, we manipulated many choice sets for subjects to choose the optimal option, since it has been reported (Muthukrishnan and Kardes 2001) that brand comparisons may result in reducing ambiguity because consumers can more easily describe which option is superior to the others, our studies involve no brand options.

##### *Study 1*

In Study 1, two trinary sets, one of digital cameras and one of laptop computers, were presented to subjects to choose the preferred option. In the three non-dominated options, two were extreme options and the rest was intermediate option. If a subject chose an intermediate option, then the response variable is equal to one; otherwise, the response variable is zero. Study 1 summaries the results of testing the compromise effect.



TABLE 1 Study 1 for testing the compromise effect

Compromise	<i>t</i> test	Variiances	Mean	Standard Deviation	<i>t</i> -value	<i>p</i> -value
	0		3.7547	1.1752		
Digital	1		4.3514	1.1599		
Cameras	Difference	Equal	-0.5966	1.1689	-2.38	0.0193
	Difference	Unequal	-0.5966	-	-2.39	0.0193
	0		3.7581	1.2239		
Laptops	1		4.6429	0.7800		
	Difference	Equal	-0.8848	1.1068	-3.51	0.0007
	Difference	Unequal	-0.8848	-	-4.13	< .0001

H1 and H4 are supported by the results of Table 1 since both *p*-values of the products are less than 0.05, whether the variiances are postulated as an equal or an unequal constant. Thus, we can conclude that the when a consumer's preference is more uncertain, he/she prefers to choose an intermediate options. On the other hand, the extremeness-seeking effect is more salient when the preference of a consumer is clear.

*Study 2*

In Study 2, the attraction effect is tested by setting the response variable equal to one if a subject chooses the option which dominates the decoy, and zero otherwise. Then, we used the *t* test is used to identify whether H2 is supported. The empirical results displayed as shown in Table 2.

TABLE 2 Study 3 for testing the attraction effect

Attraction	Response Variable	Variiances	Mean	Standard Deviation	<i>t</i> -value	<i>p</i> -value
	0		4.0580	1.1743		
Digital	1		3.8095	1.2891		
Cameras	Difference	Equal	0.2484	1.2014	0.83	0.4089
	Difference	Unequal	0.2484	-	0.79	0.4380
	0		4.2453	1.0544		
Laptops	1		3.7297	1.2834		
	Difference	Equal	0.5156	1.1536	2.09	0.0399
	Difference	Unequal	0.5156	-	2.01	0.0479

The empirical results partly support H2. For digital cameras, the attraction effect is not affected by the uncertainty degree of a consumer's preference. However, a consumer's preference certainty plays a significant role in affecting the attraction effect for laptop computers. Thus, further research should be considered to examine how consumer preferences affect the attraction effect.

*Study 3*

The similarity effect has been less discussed than other context effects in previous research. In Study 3, we set the response variable as one if a consumer shows the similarity effect, and zero otherwise. Table 3 summarizes the results of testing the similarity effect.

TABLE 3 Study 3 for testing the similarity effect

Similarity	Response Variable	Variiances	Mean	Standard Deviation	t-value	p-value
Digital Cameras	0		3.4000	1.0556		
	1		4.1200	1.1964		
	Difference	Equal	-0.7200	1.1751	-2.17	0.0330
	Difference	Unequal	-0.7200	-	-2.36	0.0278
Laptops	0		3.5500	0.7592		
	1		4.2273	1.1204		
	Difference	Equal	-0.6773	1.0496	-2.53	0.0133
	Difference	Unequal	-0.6773	-	-3.10	0.0033

From Table 3, it can be seen that H4 is supported and the similarity effect is significantly influenced by the level of a consumer's preference. That is, when the consumer preferences are explicit, the similarity effect emerges. This triggers the following question of how consumers should behave if their preferences are uncertain? To resolve this question, we introduce Study 4.

In Study 4, we checked the difference of the transfer probability matrix between consumers' high degree of preference uncertainty and high degree of preference certainty. Four products, including digital cameras, laptops, mp5s, and LCDs are considered. The first question contains two options in a choice set {A,B}, where Option A has high satisfaction with price and low satisfaction with quality and Option B has low satisfaction with price and high satisfaction with quality. Then, we added Option E, which is similar to Option A, into the choice set and calculated the transfer probability of products. Table 4a summarizes the results of the transfer probability matrix with high degree of preference uncertainty for consumers.

TABLE 4a Transfer probability matrix with high preference uncertainty

High Degree of Preference Uncertainty	Option A	Option B	Option E	Total
Option A	23 38.33%	3 5%	34 56.67%	60 34.68%
Option B	1 0.88%	70 61.95%	42 37.17%	113 65.32%
Total	24	73	76	173

The initial choice shows that 34.68% of consumers with high degree of preference uncertainty prefer the price factor and the remaining 65.32% of consumers prefer the

quality factor. Then, the transfer probability matrix indicates that 95% of the consumers would still choose Option A or the similar product, Option E, if consumers originally chose Option A. On the other hand, if consumers choose Option B, 38.05% of the consumers would switch to Option A or E.

TABLE 4b Transfer probability matrix with high preference certainty

High Degree of Preference Certainty	Option A	Option B	Option E	Total
Option A	10 28.57%	2 5.71%	23 65.71%	35 18.72%
Option B	2 1.3%	123 80.92%	27 17.76%	152 81.28%
Total	12	125	50	187

In contrast, consumers with a high degree of preference certainty show a relatively persistent choice, even when Option E is added into the choice set. Only 19.08% of the consumers changed their preference, i.e., from quality to price, when they had originally chosen Option B. In addition, consumers who originally chose Option A displayed behavior similar to consumers with high degree of preference uncertainty when Option E was introduced.

## 5. Discussions

The empirical findings indicate that the preference may significantly affect what kinds of context effects are salient. For example, the compromise effect is salient when the degree of uncertainty of a consumer's preference is higher, since the intermediate options are safer and justifiable by the consumer and others. On the other hand, if a consumer's preference is more explicit, the similarity and extremeness-seeking effects are significant, since the consumer is less influenced by the context. This consideration can imply that the certain preference of a consumer may generate a skewed ideal point, which is the desired option in a consumer's mind, and thus result in the similarity and extremeness seeking effects.

Consider Figure 2 as an example. If a consumer prefers Attribute 2 to Attribute 1, he/she may set up an ideal point  $I_2$  when the context set {A, E} is considered. Then when an Option E is introduced, he/she may still choose Option A or switch to Option E, but never consider Option B since Attribute 2 of Option B is too small. On the contrary, if he/she prefers Attribute 1 to Attribute 2, he/she will still hold Option B whether Option E is introduced or not. Therefore, the similarity effect emerges. On the other hand, the extremeness-seeking effect can be similarly explained as the above statement by replacing Option E by Option C.

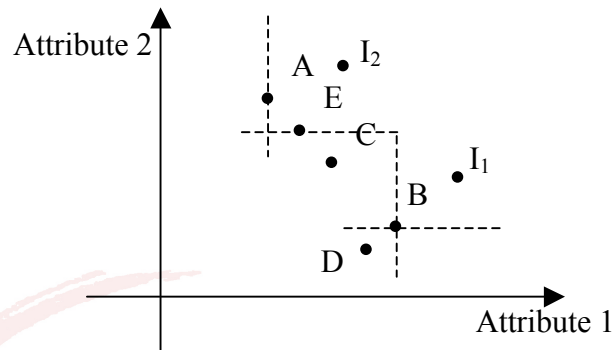

Figure 2. Ideal points of the context

In addition, the empirical findings also show that the attraction effect is not mainly affected by the preference uncertainty, since H2 is only partly supported by Study 2. Compared with other context effects, the attraction effect is an easy way for consumers to select the target option. Because the decoy option is dominated by the target option, but not dominated by the competition option, this will reduce the ambiguity toward the context. Hence, it is easy for consumers to select the target option to eliminate the discomfort of ambiguity. However, other factors or interaction effects should be further explored to precisely explain the attraction effect.

Furthermore, we find that a novel context effect, called, the switching effect, displays a different behavior against the similarity effect when the uncertain degree of a consumer's preference is significant. In Figure 2 for example, the switching effect indicates that a consumer may switch his/her option from Option B at the choice set  $\{A,B\}$  to Option A or E at the choice set  $\{A,B,E\}$ . This result can explain why the preference structure of this consumer is unstable and easily influenced by the context. Therefore, if adding Option E into the context  $\{A,B\}$ , the consumer may wonder whether Attribute 2 is more important than Attribute 1 since more options highlight the function of Attribute 2. Thus, it is safer to forgo Option B and choose Option A or E due to the unstable preference structure.

Finally, the decision strategies, i.e., compensatory and non-compensatory strategies, may be related to the degree of preference uncertainty of consumers and be other reasons for the emergence of context effects. If a consumer uses the non-compensatory strategy, the extremeness-seeking and similarity effects are more salient. On the other hand, if a consumer uses the compensatory strategy, the compromise and switching effects are more significant. However, as previously mentioned, the decision strategies which consumers adopt may combine both perspectives as one point of a spectrum. Hence, the conventional behavioral models which only consider the optional attribution are not enough to propose a sound model. A behavioral model should incorporate more factors to reflect the varieties of purchasing behavior.

## 6. Conclusion

This paper examined whether the degree of preference uncertainty accompanying the decision strategies may result in different context effects. The empirical studies indicate that a high degree of preference uncertainty highlights the compromise and switching effects. In contrast, a low degree of preference uncertainty may enhance the extremeness seeking and similarity effects. However, the attraction effect seems less related to the degree of preference uncertainty and may be mainly affected by the

differences of attributes between options.

Furthermore, context effects may affect the decision strategies that consumers adopt. If consumers are likely to adopt the compensatory strategy, the compromise and similarity effects should be salient. On the other hand, when a consumer mainly uses the non-compensatory strategy, the extremeness-seeking and similarity effects are significant. However, the switching effect still cannot be well explained neither by the compensatory nor non-compensatory strategy. Hence, further studies should be proposed to further test the relationships between preference uncertainty, decision strategies and context effects.

## References

- Ariely, D., & Wallsten, T. S. (1995). Seeking subjective dominance in multidimensional space: an explanation of the asymmetric dominance effect. *Organizational Behavior and Human Decision Processes*, 63, 223-232.
- Baron, J. (2000). *Thinking and deciding*. Cambridge: Cambridge University Press.
- Busemeyer, J. R., & Townsend, J. T. (1993). Decision field theory: a dynamic-cognitive approach to decision making. *Psychological Review*, 100, 432-459.
- Busemeyer, J. R., Wang, Z., & Townsend, J. T. (2006). Quantum dynamics of human decision making. *Journal of Mathematical Psychology*, 50, 220-241.
- Camerer, C., & Weber, M. (1992). Recent developments in modeling preferences: uncertainty and ambiguity. *Journal of risk and uncertainty*, 5, 325-370.
- Chen, J., & Rao Hill, S. L. (2009). Task factors and compromise effect in consumer choice. The Australian and New Zealand Marketing Academy Conference (ANZMAC).
- Dhar, R., Nowlis, S. M., & Sherman, S. J. (2000). Trying hard or hardly trying: an analysis of context effects in choice. *Journal of Consumer Psychology*, 9, 189-200.
- Frisch, D., & Baron, J. (1988). Ambiguity and rationality. *Journal of Behavioral Decision Making*, 1, 149-157.
- Gigerenzer, G., & Selten, R. (Eds), (2001). *Bounded rationality: the adaptive toolbox*. Dahlem Workshop Report. Cambridge, MA: MIT Press.
- Gourville, J. T., & Soman, D. (2005). Overchoice and assortment type: when and why variety backfires. *Marketing Science*, 24, 382-395.
- Gourville, J. T., & Soman, D. (2007). Extremeness seeking: when and why consumers prefer the extremes. HBS Marketing Research Paper (07-092).
- Kahneman, D., Knetsch, J. L., and Thaler, R. H. (1991). Anomalies: the endowment effect, loss aversion, and status quo bias. *Journal of Economic Perspectives*, 5, 193-206.
- Heath, C., & Tversky, A. (1991). Preference and belief: Ambiguity and competence in choice under uncertainty. *Journal of Risk and Uncertainty*, 4, 5-28.
- Herne, K. (1999). The effects of decoy gambles on individual choice. *Experimental*

Economics 2, 31-40.

- Highhouse, S. & Johnson, M.A. (1996). Gain/Loss asymmetry and riskless choice: loss aversion in choices among job finalists. *Organizational Behavior and Human Decision Processes* 68, 225-233.
- Huber, J., Payne, J. W., & Puto, C. (1982). Adding symmetrically dominated alternatives: violations of regularity and the similarity hypothesis. *Journal of Consumer Research*, 9, 90-98.
- Huber, J., & Puto, C. (1983). Marketing boundaries and product choice: illustrating attraction and substitution effects. *Journal of Consumer Research*, 10, 31-44.
- Kivetz, R., Netzer, O. & Srinivasan, V. (2004a). Alternative models for capturing the compromise effect. *Journal of Marketing Research*, 41, 237-257.
- Kivetz, R., Netzer, O. & Srinivasan, V. (2004b). Extending compromise effect Models to complex buying situations and other context effects. *Journal of Marketing Research*, 41, 262-268.
- Lehmann, D. R., & Pan, Y. (1994). Context effects, new brand entry, and consideration sets. *Journal of Marketing Research*, 31, 364-374.
- Muthukrishnan, A. V., & Kardes, F. R. (2001). Persistent preferences for product attributes: the effects of the initial choice context and uninformative experience. *Journal of Consumer Research*, 28, 89-104.
- Payne, J. W., Bettman, J. R., & Johnson, E. J. (1992). Behavioral decision research: a constructive processing perspective. *Annual Review of Psychology*, 43, 87-131.
- Ratneshwar, S., Shocker, A. D., & Stewart, D.W. (1987). Toward understanding the attraction effect: the implications of product stimulus meaningfulness and familiarity. *Journal of Consumer Research*, 13, 520-533.
- Roe, R. M., Busemeyer, J. R., & Townsend, J. T. (2001). Multialternative decision field theory: a dynamic connectionist model of decision making. *Psychological Review*, 108, 370-392.
- Sattath, S. (1989). The maximization principle and constructive decision theory, Department of Psychology, Hebrew University, Jerusalem 91905, Israel, unpublished dissertation.
- Shafir, E., Simonson, I., & Tversky, A. (1993). Reason-based choice. *Cognition*, 49, 11-36.
- Shafir, E., & Tversky, A. (1992). Thinking through uncertainty: nonconsequential reasoning and choice. *Cognitive Psychology*, 24, 449-474.
- Sheng, S., Parker, A. M., & Nakamoto, K. (2005). Understanding the mechanism and determinants of compromise effects. *Psychology & Marketing*, 22, 591-609.
- Simonson, I. (1989). Choice based on reasons: the case of attraction and compromise effects. *Journal of Consumer Research*, 16, 158-174.
- Simonson, I. and Tversky, A. (1992). Choice in context: tradeoff contrast and extremeness aversion. *Journal of Marketing Research*, 29, 281-295.



- Svenson, E., Osherson, D., & Smith, E. (1989). An advantage model of choice. *Journal of Behavioral Decision Making*, 2, 1-23.
- Tversky, A., Context effects and argument based choice, paper presented at the Association for Consumer Research Conference, Maui, Hawaii, 1988.
- Tversky, A., (1972a). Elimination by aspects: a theory of choice. *Psychological Review*, 79, 281-99.
- Tversky, A., (1972b). Choice by elimination. *Journal of Mathematical Psychology*, 9, 341-367.
- Tversky, A., & Kahneman, D. (1991). Loss aversion in riskless choice: a reference-dependent model. *Quarterly Journal of Economics*, 106, 1039-1062.
- Tversky, A. & Sattath, S. (1979). Preference trees. *Psychological Review*, 85, 542-573.
- Tversky, A., Sattath, S., & Slovic, P. (1988). Contingent weighting in judgment and choice. *Psychological Review*, 95, 1179-1189.
- Tversky, A., & Simonson, I. (1993). Context-dependent preferences. *Management Science*, 39, 1179-1189.
- Luce, R. D. (1959). *Individual choice behavior: a theoretical analysis*. New York: Wiley.
- Luce, R. D. (1977). The choice axiom after twenty years. *Journal of Mathematical Psychology*, 15, 215-233.
- Sheng, S., Parker, A. M., & Nakamoto, K. (2005). Understanding the mechanism and determinants of compromise effects. *Psychology & Marketing*, 22, 591-609.
- Wedell, D. H. (1991). Distinguishing among models of contextually induced preference reversals. *Journal of Experimental Psychology: Learning, Memory, and Cognition*, 17, 767-778.
- Wernerfelt, B. (1995). A rational reconstruction of the compromise effect: using marketing data to infer utilities. *Journal of Consumer Research*, 21, 627-633.

*Social Policy and Female-Headed Household in the Post Revolutionary Iran*

Shokouh Dibaji Forooshani

Tehran University, Iran

0361

The Asian Conference on Psychology & the Behavioral Sciences 2013

Official Conference Proceedings 2013



iafor

iafor  
The International Academic Forum  
[www.iafor.org](http://www.iafor.org)

## Introductions:

In the past three decades, the revolution of 1979 and eight years war between Iran and Iraq, as well as socio-economic development has brought changes in Iranian family form. These changes have faced the challenges to Iranian social policy. One of the most dramatic of these changes in the Iranian family in the recent years has been the increase in the prevalence of female-headed household. The main objective of this proposal is to examine the policy approach of the state towards single mothers: access to welfare benefits and their social rights.

### ***Research purpose***

In general, the main aim of this research is to understand the situation of Female Headed Households (FHH) in the social policies of Islamic Republic of IRAN (IRI). In this respect some more goals specifically will be studied:

- A study of family policy in relation to the poverty reduction in IRI.
- A description of FHH `s issues in relation to poverty if there are some issues
- A study of poverty alleviation policies for FHH in state, Para-state and non-state sectors. The most important measures in reduction of poverty among women can be pointed to the activities by state and Para-state organizations such as the Imam Khomeini Relief Committee, The Ministry of Social Security and The Welfare Organization which all of them receive some part of their credits from state and some of them through monetary and non-monetary contribution of people but mainly were guided by government. And non-state organizations and charities have a long history based on religion-nation tradition in Iran but the numbers of them decrease nowadays.

And at last propose some recommendations for services providers.

### ***Research significance***

Study social policies of FHH have significant theoretical and applied dimensions. It is a fundamental research that causes more recognition of economical and social-cultural situation FHH, particularly in Iran where the country has gone to the socio-political revolution and eight years war and also it is an applied research that can be helpful for prospect planning and social policies with max coverage and better supporting.

Furthermore reviewing of female headed household (FHH) social policy literature indicates that there is a little literature in the Middle East especially in Iran .Most of the literature in this field belongs to South America and Africa countries.

Islamic republic of Iran is an Islamic government and has welfare state; two categories which emphasis highly on consideration and attention to the poor people. The main slogan of the revolution of 1979 was social justice in the practical terms. Although the Islamic civil code restricts the role of women in the family and the definition of the family was a traditional one based on the law, social welfare system could not ignore the changes of family and ever increasing the number of FHH in the post-revolutionary Iran.

### **Research Problematic**

The Islamic Republic of Iran locates in the central Asia and western Asia. She is the 18<sup>th</sup> largest country in the world. Religion in Iran is dominated by the Twelver Shia branch of Islam, which is the official state religion and the majority of population, to which about 90 to 95 percent of Iranians belong. Iran has a population of around 78 million with 37 million. In 2012 of 21million household %12.1 were female headed (Iran static center, 2012).

Social structures in the Middle East have undergone rapid change through industrialization and modernizing state systems. In this context, women and the family have experienced change. Particularly in urban areas, there has been a shift from the extended household unit characteristic of classic patriarchy to a more modernized version or neopatriarchy (Moghadam and others, 2004: 19).

The statistic in IRAN shows, the fertility rate has decreased, the divorce rate has increased, the age of marriage has increased, the number of educated female has increased which all of them are the signs of changing in the families or will affect on the structure and size of families. But as the rate of employed women remained low, most of Iranian women at least economically depend on the men of their families and men are the head of the families. In the condition of absence of men in families, Iranian women have to head their families besides their previous roles. So in new conditions FHH will face with great issues.

To the sociologist, the term of female-headed household (FHH) is a descriptive term and refers to a person in the family who has qualified power in the family, usually they are the eldest person in the family and undertake the economical affairs. In Iran more than 88% of families are headed by men (Iran statistic center,2012) and “for men to be a breadwinner in the family” is so acceptable and norm in the society that there is not a social problem as “male- headed family” and it is the female headed which would be considered as a kind of social problem and pathology (Moeidfar,2007:133).

FHH are women who are in charge of their households, managing the economical affairs of the families and taking critical decisions in their families, absolutely or particularly in the absence of an adult man (Forouzan, 2003:38).FHH is divide into three main groups: first group which refers to families that there are not any men; widows, divorced and unmarried girls who live alone. Second group are families that their men temporary are absent ,due to migration ,missing ,running away ,prisoner ,military service .Third group consist of families that men are present in the family but because of unemployment ,disability ,addiction they have not any role in earning a livelihood(chant,1997:96).

A general consensus on FHH vulnerable situation among all the world authorities causes a large numbers of local, national and global organizations take a part in this way. One of the major actions which have been taken in some countries, in this field is to conduct a census about them and collecting demographic which can build a basic profile of FHHs (UNDP, 1995; UNIFEM, 1995; United Nations 1996).

In Iran, while the poverty level is relatively low when measured by the commonly used yardstick of living on less than \$1a day all other measures reflect higher levels. The combined index of Human Poverty shows a poverty level of 18 percent of the population. The national measure (those with food intakes of less than 2200 calories a day) shows a similar level of poverty. Raising the relative income of the poorest sections of the population requires addressing a number of interconnected lines of priority: Based on existing surveys about the composition of this relatively deprived fifth to one quarter of the population, the old, women and rural dwellers constitutes a large share of this group. Data obtained from household surveys, shows that the composition of male-headed and female-headed households is completely different. More than one half of female-headed household consist of one or two people; more than half of male-headed household consist of five people. Other data shows that more than 80 percent of households headed by women over 60 years of age ,and 70 percent of households headed by women of less than 20 years of age, consist of one or two people .The likelihood is that these households consists of a mother and child or a

daughter and one parent. According to household income studies, such single-headed households are especially likely to live in poverty. Given that unemployment is highest among young and old people and women, it is clear that older people (and members of their household), women and younger people are disproportionately represented among the poor. Finding targeted measures to improve their situation represents important challenges (<http://www.undp.org.ir/Doccenter>, 2003:30-31).

The process of feminization of poverty is a global issues .There is an uneven and greater share of women living in poverty which is reflecting the phenomenon known as the “feminization of poverty” (The united nation, 1996).The government of the Islamic Republic of Iran, like many other governments, has foreseen specific mechanisms and indicators in the field of health, education, employment and resources in which access to and control of resources by women are somewhat more limited. The main target groups in this area are FHH and low-income women. According to Iran statistics center, in Iran the increase in FHH during the last four decades indicates that they constitute 12, 1% of all families in Iran, up from the previous rate of 7.1 % (Iran Statistic Center, 2012).

The Islamic Republic of Iran, after revolution, has emphasized the support of vulnerable groups more than any other previous government. IRI Constitution describe this state as welfare state .In this respect, in eradication of poverty numerous rules have approved, various organizations and foundations have established.

Besides in the preamble to the constitution of IRI it is stated, “As women have suffered most...realized their rights will be given priority” (National report on women`s statues in the IRI, 2005:12).

This research is studying to apprehend, what is the social policies for the poorest poor (FHH) in Iran which has welfare state and eager to promote in women situation.

### ***Research questions:***

Based on the research goals, the following questions will be primarily presented:

1. What are the specific issues in relation to poverty that FHH face?
2. Are FHH recognized as a social problem by Iranian government?



3. What type of family policies exist in the IRI?
4. What specific policies and programs are in place that target FHH in state Para-state and non-state sectors in Iran?
5. What are the possible policy recommendations?

### ***Methodology***

The methodology of this study is based on qualitative and documentary methods. In order to do this, the several in-depth interviews will be conducted in the different organizations, i.e., state organization (The Ministry of Social security and welfare Organization), Para- state organization (Imam Khomeini Relief Committee) .And Semi-structure focus interviews with some of FHH who are under protection of these organizations and foundations and some FHH who are independently managing the economical affairs of the families to any organizations.

The government of the Islamic Republic of Iran, like many other governments, has foreseen specifics mechanisms and indicators in the field of health, education, employment and resources in which access to and control of resources by women are somewhat more limited(center for women`s participation,2005:12). The welfare regime of IRI consists of three parts, insurance, supportive and relief (President Deputy Strategic Planning and Control,2010:199).

The most important measures in reduction of poverty among women can be pointed to the activities by state and Para-state organizations such as the Imam Khomeini Relief Committee, The Ministry of Social Security and The Welfare Organization, Social security organization, Behzisti, Foundation of Martyrs and Veterans affairs ,Foundation of 15<sup>th</sup> Khordad ,Red crescent society which all of them receive some part of their credits from state and some of them through monetary and non-monetary contribution of people but mainly were guided by government. And non-state organizations and charities have a long history based on religion-nation tradition in Iran but the numbers of them decrease nowadays.

Poverty is a multi-dimensional phenomenon. This is defined by more than just low monetary income. It is also defined by lack of basic needs such as access to water, food, education and health (<http://www.undp.org.ir/Doccenter>, 2003:30).

Applying above information the main methods of this research are:

-Review of published official documents, governmental laws, governmental regulations and instructions, budgets rules of IRI, some governmental planning for FHH in center for women's participation (CWP) and Islamic Republic of IRAN Expediency Council.

-In- depth interviews with governmental officiate in the state (The Ministry of Social security and welfare Organization), Para-state (Imam Khomeini Relief Committee) and NGO (Sedighin).

-Semi-structure focus interviews with some of FHH who are under protection of these organizations and foundations.

This research is going to conduct among FHH who live in district of Tehran city.

**Result:**

According to pilot study, the main issues of the female-headed households are economical aspects, distortion of social relations, affection matters and family and offspring-related problems. That the most crucial problem for female headed – household is economical aspects.

Most of the female-headed households are under protection of Imam Khomeini Relief Committee which provides them with three types of services; financial support, insurance and empowerment. In the part of financial support they give service to them in two types; Stipend and accommodation female-headed households who are under protection of Relief Committee will enjoy the stipend benefits based on their needs. Moreover the relief Committee provides varied services for the female-headed household accommodation such as, buying, rebuilding or renewing their houses or paying their monthly rent.

For the Insurance service the relief committee gives health insurance and social insurance. From 1997 Relief Committee has the responsibility of insuring the poor people. In this respect family doctor project is responsible for constant supervision of family health issues, prevention before cure and treatment. On the other hand in the part of social insurance, from 2005 all rural female -headed households 20-55 years

old who were under protection of Relief Committee introduce to the social insurance box. They can use of its benefits such as retiring insurance.

In the empowerment section which has two parts; economical empowerment and social empowerment. In this respect the committee tries to define capable female-headed households and determine proficiency and potency of their performance first of all and then try to find a suitable job for them. In the part of social empowerment it submits the legal and juridical services for female-headed households.

### ***Conclusion and Recommendations:***

Based on this primitive study it seems the privation and poverty are consequence of both individual agents and the social structure (Giddens third way policy, 1998) It means the policy in the alleviation of poverty would not be successful unless make some changes in the culture of the female-head households.

Allocation a part of budget for the female-headed household

### ***Bibliography***

**Center for Women's Participation** (2005), (Gozaresh meli da morde vazeeate zanan dar jomhorie eslamie Iran) National Report on Women's Status in the Islamic Republic of Iran, Barge Zeitoon

**Chant, S.** (1997) "Women-headed Households: Poorest of the poor? Perspectives from Mexico, Costa Rica and the Philippines

**Forouzan, S and Beiglarian ,A.**(2003),Zanan sarparast Khanevar: Forsatha va Chaleshha( Female-Headed Households: Opportunities and challenges) in Faslname Pajhohesh Zanan( Women's Research Quarterly).Vol.1,No.5, Spring 2003

**Moghadam, V** (2004) Patriarchy in Transition: Women and the Changing Family in the Middle East, journal of Comparative family Studies .Calgary: Spring 2004.Vol.35, Iss.2; pg.137, 26pgs

**President Deputy Strategic Planning and Control** (2010), Gozaresh eghtesadi sal 1387 va nezarat bar amalkard chaharsale barname chaharom tosie (Economic Report of 2008 and Control on the Function of The Forth Four-year Development Plan), vol.2 President Deputy Strategic Planning and Control press

**UNDP** (United Nations Development Program) (1995) Human Development Report, Oxford: Oxford University Press

**UNIFEM** (United Nations Fund for Women) (1995) The Human Cost of Women's Poverty: Perspective from Latin American and the Caribbean, Mexico City: UNIFEM

**United Nations**(1996) Food Security for All, Food Security for Rural Women, Geneva: International Steering Committee on the Economic Advancement of Rural Women

**Websites**

**Iran statistic center site:** <http://amar.sci.org.ir/Detail.aspx>

<http://www.undp.org.ir/Doccenter/reports/npd/cca.pdf>

iafor

*Preliminary Study of 3D Base Navigation Websites Development - Use 3D Virtual  
Temple Navigate Websites for Example*

Hsuan-Jan Kao, Li-Chieh Chen

Ta Tung University, Taiwan

0377

The Asian Conference on Psychology & the Behavioral Sciences 2013

Official Conference Proceedings 2013

Abstract

From now on, website display still uses interface visual effects as the main appeal, its goal aims to attract user's browsing interest, but in actuality, the website display is still in 2D images, text-based presentation. Hence this research will build a full 3D base virtual temple website and move the religious spirit of the actual temple, activities development to the Internet. Whether it is temple festivals or blessing will all build in full 3D Virtualization then brought network interaction, information and even gameplay to "the 3D base virtual temple websites" for development cloud Religion and applied it to smart mobile device platforms, let the busy modern spiritual sustenance at all.

Keyword: Virtualization、 Interactive、 Smart mobile devices

## I. Introduction

### Background and purpose of the plan

From now on, website display still use interface visual effects as the main appeal, its goal aims to attract user's browsing interest, but actual hit, the website display is still 2D images, text-based presentation. Thence, this research will build a full 3D base virtual temple websites and moved the religious spirit of the actual temple, activities development to the Internet. Whether it is temple festivals or blessing will all build in full 3D Virtualization then bought network interaction, information and even gameplay to "the 3D base virtual temple websites " for development cloud Religion and applied it to smart mobile device platforms, let the busy modern spiritual sustenance at all.

The general website due to factors of network bandwidth, performance of the user's computer (CPU, graphics card, memory, etc.), affecting Internet website's speed, quality, so in the program and interface design still 2D image-based, but with the speed of network bandwidth and computer hardware & software evolve faster and faster, 3D display interface computing accelerated, more and more online 3D game platform appear, those are to meet the user's visual senses, good visual design is one of the most direct concern to stimulate and attract users to browse and using the website. Therefore, this "3D virtual temple website" planning use the game engine Unity 3D (Hereinafter referred to as U3D) to build 3D website, U3D is a game engine developed by Unity Technologies, its features are well known in with affinity easy to use and much easier to learn the operation interface, it can compatibility with 3ds Max, Maya and other famous 3D production software designed 3D models and 3D animation. In the interactive program control is based on the C language, JavaScript, Boo script as the main programming language, it has relatively high degree of freedom In the development, the compatibility in various platform is also very high, In addition to the Mac, it supported Windows and other platforms, smartphone platform like iOS、Android all can run U3D developed game、interface, may increase the use in variety of hardware facilities, let the busy modern spirit, spiritual sustenance at all.

## II literature

The plan will use U3D as the primary development platform, it may increase use in the variety of hardware facilities. However, the common 3D website technology in the general site is the application need to first explore to understand the pros and cons of



building the current 3D website development technology. While we discussing 3D website, "Second Life" the 3D virtual community site developed by Linden Lab can learn about the importance and advantages in the internet era about building 3D website.

### 1.Unity 3D

U3D can be quickly and easily in prototyping . The multi-platform development is most advantageous function of U3D. But the ease of use of the tool, as well as the power of the API, able to dive into the depths of the program, understanding and application of low-level operation is more important advantages. The U3D official found that about 90% condition can meet customer demand; these old features are built-in, when customer need to go deeper change the bottom of the program, the U3D official will fully support reached.

A cross-platform game development editor

The U3D itself support to production of multi-platform games, it can development games of iPhone, Web, Xbox 360, Android and PlayStation.



Figure1: <http://chinese.engadget.com/2006/02/28/what-would-steve-jobs-do-result/>.

### Deferred Rendering

The U3D provide cutting-edge technology of the lighting system, hundreds of point light sources can be placed in the scene, instead of a huge performance impact. With G-Buffers, U3D provide "deferred rendering technology" this functionality to produce high-quality images, and not lose too much computer performance.

### Beast Lightmapping

U3D provide best light mapping technology "Beast" in the industry, this technology is used in many popular game of the 3A level. Previously, Beast charge per game license of up to \$ 90,000, but this now has become a built-in function. Beast light maps are able to have beautiful effect interaction with the real-time dynamic light sources, when the object close to the camera, U3D will switch to instant light, so that you have the most delicate shading details. (Figure II)

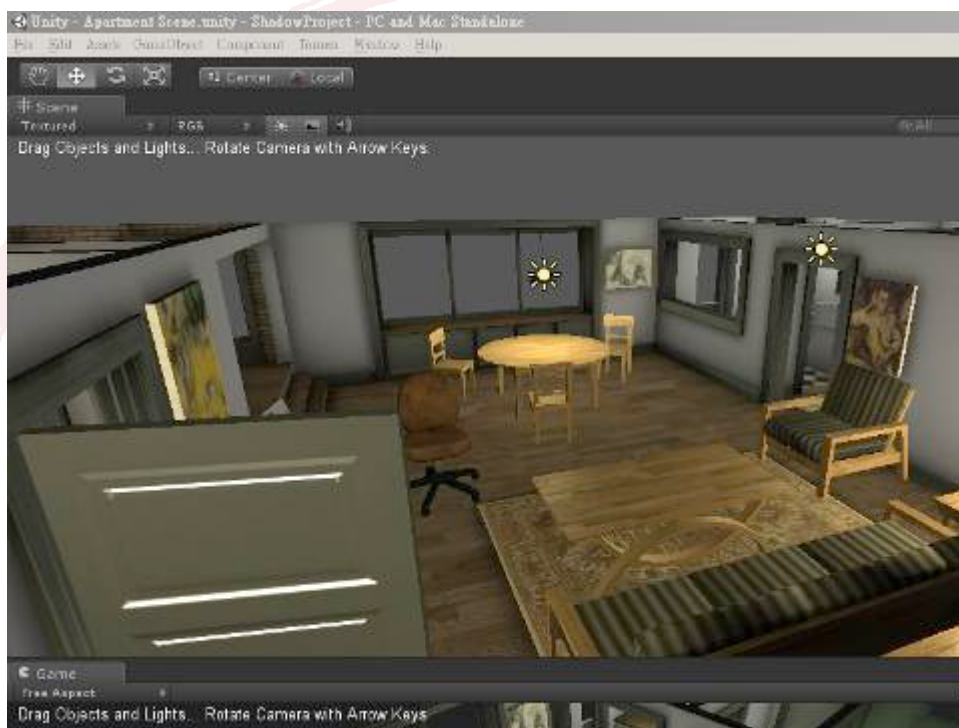

Figure2: Unity official website.

#### 4. Camera Lens Effects

U3D upgrade the post-effects, the software itself is wrapped in a lot of special effects, such as Kill Zone game special effects inside. There is a light plumes, the depth of field of the high quality, internal lens reflections, stroke, depth of field, color correction (depth-aware color correction) ... and so on, those make the camera function more comprehensive.

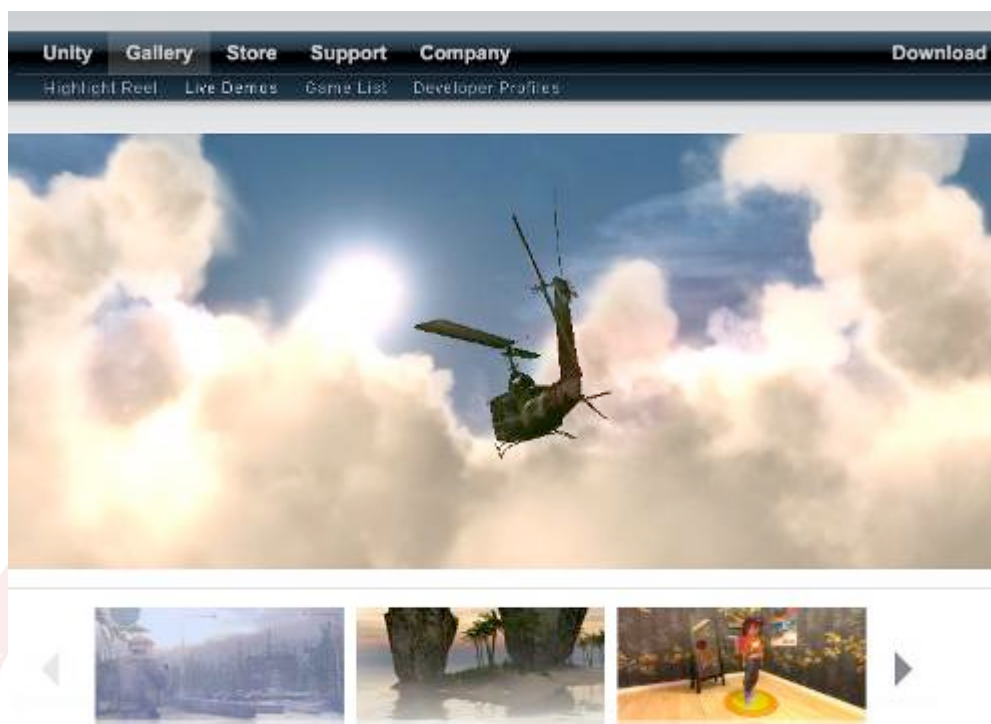

Figure3: Unity official website.

### 5. Source-level Debugging

For program designers, U3D provide the convenient script debugging features through MonoDevelop can be used on both Windows and Mac platforms. Those features can suspend the game, for each line of code editing, set breakpoints, view variables, different from the early print-based debugging and greatly enhance the work efficiency of the program staff.

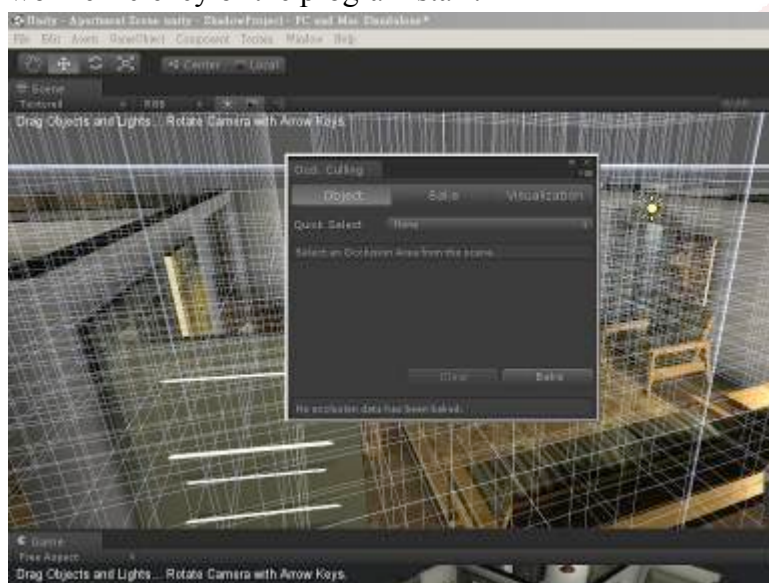

Figure4: Unity official website.

## 6. Asset Management function

When conduct a large-scale project, this feature can help the project to quickly find the material assets, U3D now add a "the content browser, it has the ability to preview the material assets of the scene that contains the label with the search function, you can quickly find the desired material.

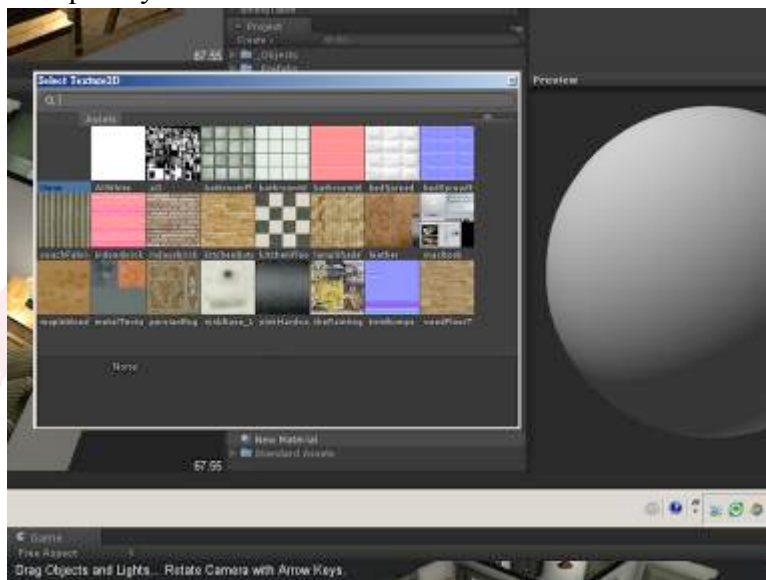

Figure5: Unity official website.

## 7. Sound effect function

U3D added Reverb Zones, filters, tracker file support management tools and provide falloff curves for all major audio editing, and that is why it can completely control the environment sound.

## 8. Occlusion Culling

About game performance problems on the phone, even with fast hardware, customer will be still asked to get better performance, that's why U3D provide "occlusion culling" system. This system can be used in mobile devices, web pages, and game consoles. It does not need to increase any budget; the system is come with U3D, so that company cost savings.



圖六：奇銳科技官網。

Game developers often use scripts editor to add some features to strengthen the integrity of the process and file contains output material or change default model import options, of course, they will write other things, one of which is a version of the game build script. Game companies often have to create different versions of the game for different publishers that have different hardware limitations, in the Unity editor they write extensions for different games, Unity editor such as level editor, use customized assets, so that it can be able to integrate the current scene without requiring Excuse programmers.

iafor



## 2. Flash 3D Plug-in category : Papervision3D

The more mature production technology in 3D website making history was FLASH 3D, early, Flash relative lack of application in the 3D field, most of time it only rely 3D software to output continuous sequence drawings or use their own mathematical formulas to calculate the simulated 3D effect, the continuous picture only can one-way play and cannot be generated in real time interaction. Up to Web2.0 era applications emphasis on user interaction, the development of 3D technology can play in Flash Player, with small size, excellent interaction with the user and the effect of realistic 3D simulation; 3D web applications will undoubtedly bring users all new visual experience. (Green milk tea, 2009). The development of this technology let 3D effect is not only just in a single transmission on the animation but also more interactive operation to increase website interesting and immersive visual experience. Therefore, in this context, generating a Flash3D category-Papervision3D (Referred to PV3D), PV3D is not software either new programming languages, which is a Flash Action Script open source-based technology, it aimed at achieving the more dazzling with higher interactive powerful Flash 3D Web applications. The earliest PV3D test version is published in the July 7, 2007, which continuous development and maintenance by a group of core members. And development the PV3D web applications only need to use Flash Action Script 3.0 with PV3D class file (similar plug-in), the client (user) can watch only need to install the Adobe Flash Player 9 or more version.

The PV3D produce 3D effects are out by the mathematical formula, but have been packed into the off-the-shelf category of plug and very convenient in use. Although Flash Player10 now add the small 3D functionality, all visible objects (Display Object) have x, y, z, rotationX, rotationY, rotationZ, such as property, but its performance still not good as PV3D and the development team has developed Flash10 version of PV3D, Therefore, the role of PV3D is still irreplaceable.





Figure7: Use PV3D technology to produce virtual underwater world website

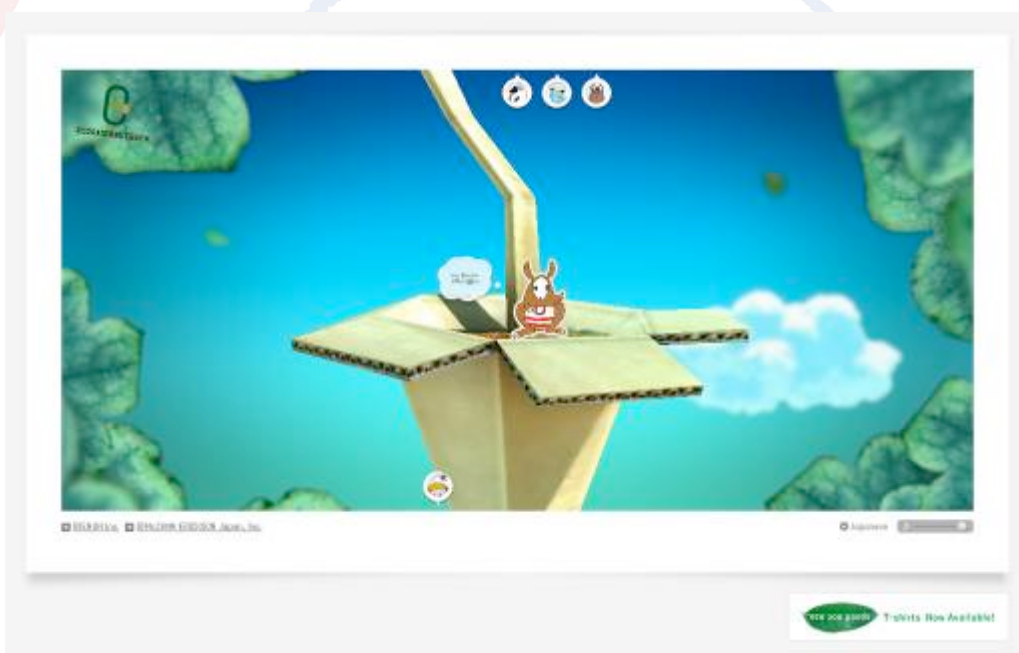

Figure8: Use PV3D technology to produce 3D website. <http://ecodazoo.com/>

The PV3D provide many useful objects and methods to help us deal with the complex mathematical operations let us can easily simulate 3D world in Flash. Relative, if computing of PV3D experience too complicated models or large number of 3D objects, it will consume a lot of CPU usage, so the number nodes of model (constituting the number of faces) and the number control of objects are very important. The bitmap processing of Flash itself, there are many fly in the ointment, such as bitmap scaling or rotating effect when there are jagged, even use PV3D there is no exception, so you can open a picture smoothing function to alleviate this problem. Use PV3D can toward interactive and interesting direction to apply, as for

the texture on flaws can be considered to strengthen them to some art techniques that are use of 3D map drawing skills to complement the model number of faces problem. Figure 3 describes car's 3D website is use of maps drawn techniques to produce realistic cars entities effect. In figure4, 3D website using mapping techniques to create a unique visual style and increases its interactive view fun.



Figure9: <http://www.playsmart.jp/>

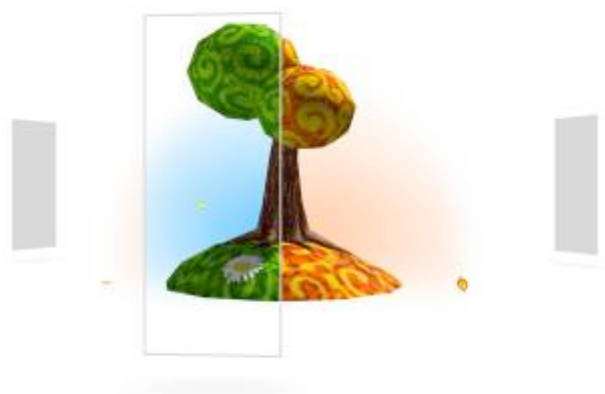

Drag mouse to rotate, scroll mouse wheel for zooming & walking through portals to another season. Keyboard arrows work too. Love your comments in my blog. Subscribe to my RSS for more cool stuff like this.

Figure10: <http://www.cleoag.ru/labs/flex/parkseasons/>

### 3 Principle of PV3D

Model and texture:

Three points connected into a triangle and a lot of triangles to form a

model. The texture is the model at each point  $(x, y, z)$  of corresponding plane  $(u, v)$ ,  $u, v$  is bitmap plane  $x, y$ , merely point has been used  $x, y$ , and to be avoid duplication. The map inside Flash3D is calculated according to different slope of each triangle and each point corresponds to the UV calculated beginBitmapFill second matrix parameter (matrix) to use bitmaps filled triangle. (Figure 5)

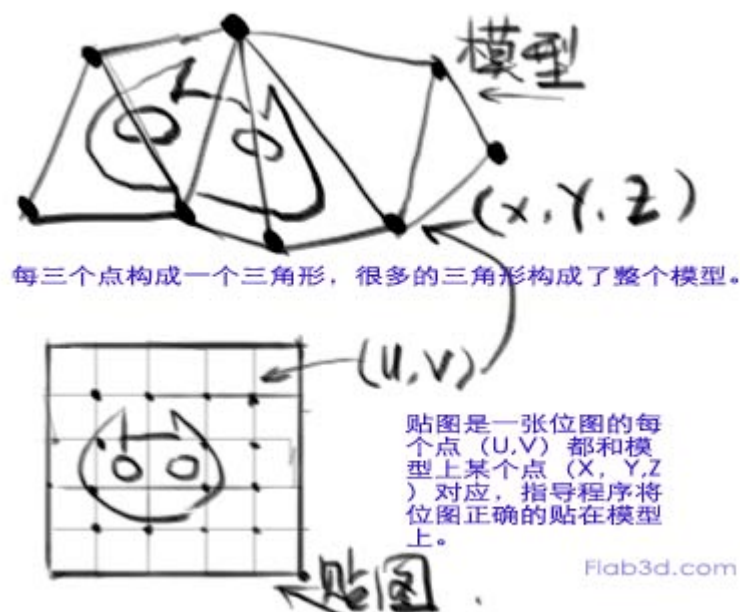

Figure 11: <http://www.5uflash.com/flashjiaocheng/flash-3d/5450.html>

The movement principle of Flash3D is major change of coordinates and generates a dynamic sense of move feeling, thus in our visual what we thought moving point and the model is actually not moving at this movement what might move just coordinate system. And what we thought point move, rotate, zoom and perspective is all the same principle, but is on the move, rotate, zoom, perspective these points and the model coordinate system where only. So, Camera movement is the model coordinate system around the axial rotation. All the points have any change is a point  $(x, y, z)$  multiplied by a matrix obtained. The categories have been defined in the PV3D and all the expressions like plug-in are convenience for we apply.

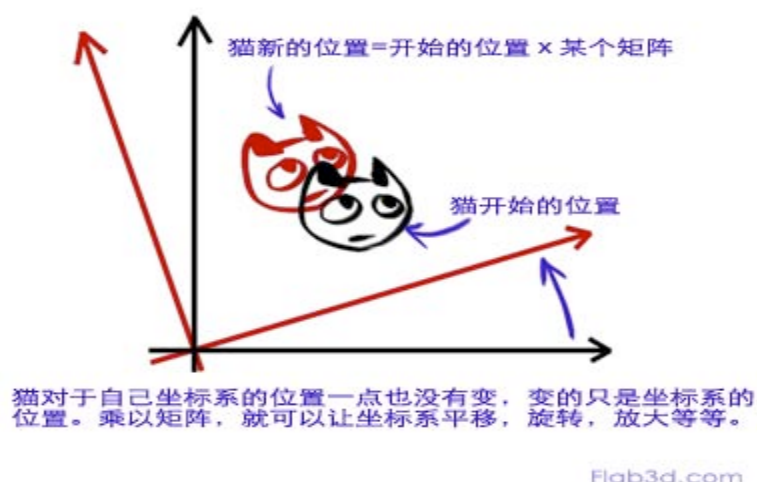

Figure12: <http://www.5uflash.com/flashjiaocheng/flash-3d/5450.html>

Projected on the screen:

Although it is "3D" but in fact it still viewed on a flat 2D screen. It must take the 3D point  $(x, y, z)$ , becomes only the  $(x, y)$  of the points that are displayed on the plane of the screen. Specifically, 3D point is the projection of the point in the plane of the canvas. If you remove the  $z$  values directly from  $x, y, z$ , while an  $(x, y)$  of the point can be obtained, but such projection graphics would be no changes in the near and far, and therefore produced a "perspective projection", the algorithm is used  $x, y$  divided by a value  $w$  and  $Z$  to obtain the perspective view of a distance of  $(x, y)$ , this is what we usual see a 3D image of most normal distance. (Figure7).

如果把(X,Y,Z)直接去掉Z，投影在屏幕上表现不了近大远小的透视，无论远近，物体在屏幕上都是一样大的。这叫做平行投影，实际运用中不真实。

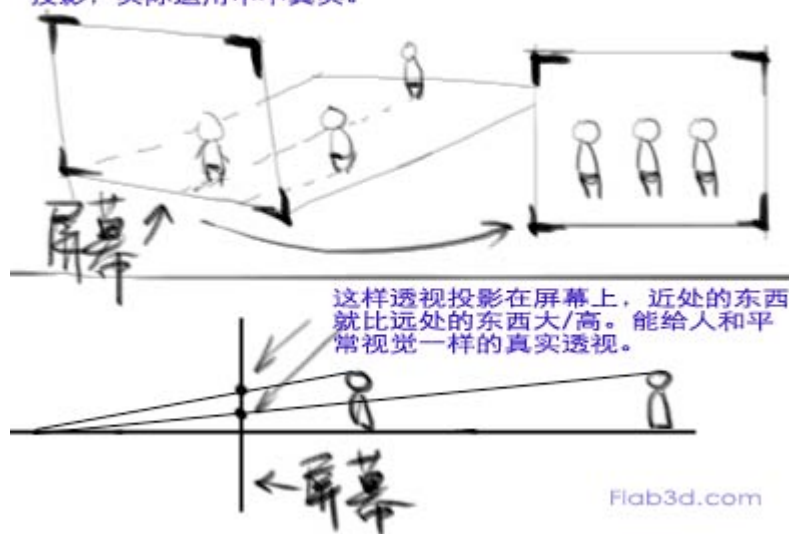

Figure 13: <http://www.5uflash.com/flashjiaocheng/flash-3d/5450.html>

Thus, 3D graphics theory is the basis of the main principle which forming Flash3D, also mathematical formula formed the Action Script code, but it need to have more mature concept of mathematical logic, use Flash authoring 3D website also needs to have certain program basis, to test construct 3D website often takes more time to develop the program and understand the way of use PV3D plug-in. This project attempts to use Unity 3D game engine to develop 3D websites, mainly that it is in very high compatibility with 3D production software, users familiar with 3D software (such as 3ds Max, Maya) is quite convenient used to it. Users into the Unity 3D to create interactive interface control, there are number of functions that can be applied.

Flash is a very strange software, because it is not designed for develop games in the beginning, it can only develop the game through the plug-in; the U3D is a game engine specifically for game development and capable of making the latest game. If you want to change the future of games on the network, you will expect to see the next level of game on pages, the Flash may not be able to achieve this level. (Mirax technology Corp Official Website) Compared to Flash itself is a 2D vector-based authoring software, although there are the PV3D quite mature 3D technology, but it still relative lack of the degree of compatibility with other 3D authoring software, for example, the restrictions of the maps, there are many restrictions of dynamic skeleton support, but U3D its compatibility is very large, convenient, simple and is quite suitable tool to build 3D websites.

360 degree VR Panorama 3D websites:

Such 3D website technology is place the digital camera in a space in the middle position take 360 degrees panorama shooting the actual scene into a continuous digital images, then it synthetic series with software, the continuous drawing concatenated into site similar to the three-dimensional virtual 3D space, such as 3D Space 720 degree video surround system, it is a system developed by the three-dimensional network technology companies, with static surround Videos of the digital camera, through computer software technology and applications, make video on internet can up and down around it or left and right surround like dynamic video, image file size is only like a normal plane JPG compressed image file and small file size suitable for use in the internet. (Three-dimensional official website, 2008) Such sites are dioramas reconstruction, belonging to the picture type of browser, not really pure 3D models built website, but suitable for website cases of actual field conditions to be faithful.





Figure14: Artistic creation 3D online exhibition,  
<http://www.3dspace.com.tw/sample/fhsh/show/>



Figure15: Campus Tour of the Affiliated Senior High School of National Taiwan Normal University,  
<http://www.3dspace.com.tw/sample/hsnu/>

3D websites and Panorama 3D website are very different in the actual implementation techniques and browse operation mode also have many differences ,the comparison of two types websites may simple be seen from the following table:



Table1: The differences between virtual scene and panoramic photography

Comparison differences between virtual scene and panoramic photography		
Items of comparison	3D 虛擬場景 3D virtual scene	Panoramic photography
1. Production methods	Numerous three-dimensional model of simulation constructed	Ttake few photos connected together to position, rotation and surround
2 Visual effects	meticulous 3-dimensional detail, but inevitably the actual gap	Real photo panorama presented, but only 2D plane effect
3 Range of presents	From any angle of any object or any object in any corner of the scene can do a virtual extension	360-degree photographs from the inside and out, and scene is limited to reality
4. Scenes interaction	Sneak into the virtual space, walk and interact with the virtual objects	first-person orbital rotation on Left and right or up and down the designated to zoom in or out of a photo
5. Production costs	Production process is difficult and time-consuming long	Production process is easy and fast
6. Use threshold	Higher requirements of hardware and network bandwidth	Lower requirements of hardware and network bandwidth
7. Extending the application	Unlimited	Web links

Data source: <http://blogs.villamood.com/james/2010/10/21/1482/>

From table above can find out that 3D virtual website application on larger elasticity, the relative production processes is long and technically need higher threshold, but its interactivity, better gameplay and increase of cases in a variety of products marketing design flexibility, "user innovation" will be the key to success. The rapid development of the internet, it not only for information, published works, marketing, advertising and commercial transactions, and further, there are thousands of people online on the formation of another society, has the exclusive currency in circulation, commercial

activities, society organizations, media coverage, influence increasingly expanding, the truth is not only entities stationed virtual, virtual entity can counterattack. (Commonwealth Magazine)

Era of Web 2.0 emphasized the features and user interaction; therefore, build 3D website should be able to truly meet the spirit of its innovative interactive features.



## Second Life 3D Community Website:

Now, most prevalent 3D website should be the Second Life of virtual community website, Second Life (<http://secondlife.com>) is an online game created by Linden Lab in 2003, but it is not an ordinary online game you can fight with monsters. Wikipedia: Second Life (Second Life, abbreviation SL) is an Internet-based virtual world, in late 2006 and early 2007 due to the mainstream news media coverage it has been widespread concern. Through a downloadable client program developed by Linden Lab, the user called "residents" in this game, they can communicate with each other through the movement avatars. This set of programs is based on a common Meta universe that provides a high-level social networking service. Residents can get around and encounter other residents, socialize, participate in individual or group activities, manufacturing and trading of virtual property and services.

「Second Life」 as one of the virtual world, no doubt inspired by the computer punk literary movement, especially Neal Stephenson's novel 「Snow Crash」. Linden Lab said their goal is precisely to create a meta-universe kind of world like Stephenson described. In this world, people can own their unique way to define how to interact with others, play, do business or exchange. Second Life's virtual currency called Linden Dollar (Linden, or L \$). You can exchange Linden Dollar by the residents in the form of specialized markets, Linden Labs and some entities to be converted into U.S. dollars.

「Second Life」 is sometimes considered to be a game, but it does not have integral, plot points, winners, losers, levels, an end-strategy or like other games have some kind of features. Until now, it has total about 500 million users registered, but many users are not very active, and some residents have multiple accounts.

SL through the virtual reality to simulate virtual reality world, all the way of life in the real world can be realized in SL, because it is a Virtual world so adds some magic function, for example: people can fly for movement. Commercial behavior in the SL also rows for many years, Linden Lab has previously estimated, second Life has about 60 million U.S. dollars' worth of products in the Second Life transactions in 2006, Seven thousand companies have officially stationed profitability. Monthly economic growth of 10 to 15% in second life, similar to the increase in the population with the game, the daily virtual goods transactions is amounting to \$ 650,000 (about NT \$ 21 million).

The official units also stationed in this piece of technology wonderland. The Swedish Foreign Ministry's Institute of Sweden opened the Embassy of Sweden in "Second Life" that is "Second Life" diplomatic official units. It guides the users how to apply for a visa in the real world and provide information about Sweden. SL it's not just a 3D virtual reality game, but also formed millions of households in Community have the economies of scale, with the business community, advertisers, politicians have stationed. (Commonwealth Magazine, 2007) Therefore, 3D virtual website in Internet applications has a certain appeal, and use U3D game engine to build it, in addition to its convenience, compatibility, and hope to use the elasticity of its interactive program developed to increase "3D virtual temple website" more interactive games.

### Research methods and steps

This project will use U3D game engine to build 3D virtual temple website ", the initial model will simulation the Kuan Temple in Changhua City, establish full 3D temple website, after the completion there will run CB (Close Beta closed test) for network transmission 、 browse smoothness 、 browser compatibility testing and interactive operability test. After CB, then goes OB (Open Beta test public) open for all Internet users to use for testing, one for the training of the elderly population is corporate questionnaire to easy use understanding of this website, also use test for a variety of hardware platforms. Completed the test from the questionnaire were analyzed to understand the "3D virtual temple website" development future.

#### Step Description:

1. Temples, statues referenced drawing shooting records: as to build basis of 3D models, textures, and advance to the Emperor Guan Temple main hall space and the Lord God. It will take time about one month.
2. The website architecture set: that is theme website content set will be the function of the actual temple, event planning site content, such as virtual visits to the Yasukuni, virtual temple fairs, virtual hexagram, and virtual puja and put the actual action of the temple onto the cloud. It will take time about one month.
3. Build virtual reality scenes: the appearance of the temple construction, internal main hall, the Lord God to build complete, and the first-person navigation test. It will take time about two month.
4. Establish interactive operating system: the overall website operating mode settings, interactive programming and development, and development of a simple game content increase interactive games. It will take time about two month.
5. Test surveys data analysis and modifications: The completion of the site for users to test and do surveys, the use of the test in a variety of platforms, for survey questions conduct website modify, re-test and analysis statistics necessary the pros and cons of this plan website built. It will take time about five month.

Software used in this project is Unity 3D game engine development software, currently widely used by major domestic game companies; mainly its software compatibility is very large, two heavy weight Autodesk's 3D production software Maya, 3ds Max its file produced content can be directly input to the setting of the Unity 3D interactive program, online game development is quite mature, the release of the files encountered the successful implementation of various browsers. Unity 3D contains the most powerful engine can be fully integrated professional technical and achieve true cross-platform game development environment, using this set of game engine can create up to \$ 1 million more than the surrounding effective. Unity 3.0 is the latest version, there is a marked improvement in the functionality of the editor and Light mapping, resource management, program debugging, physical performance and art operating section becomes more intuitive, in addition, it increase support for X360, PS3, iPhone, iPod Android and other platforms, also authoring tools for web games. U3D can be quickly and easily prototyping, so the development team can focus more on the level of game design, reduce the cost of error trying.

Therefore, this project to build the "3D virtual temple website" is an important milestone in combination of digital media design and the cultural and creative

industries, by build of this website, it not only computer can browsed on the internet but also operation in variety of hardware platforms and smartphone platform, through this site users can real spiritual exchange in the air anytime and anywhere, and design a simple interface operation to promote the development of the elderly network use ethnic groups, thus narrow the communication distance between family generations.

Star wooden images company build website, development of digital content case of considerable size, by the company's rich industrial strength, experience, so that the industry-university programs will be more practical problem solving ability, and through this project build 3D temple demonstration website, for which the company has developed the possibility of customers that belonging to traditional industry categories, open up the door to information technology for the spirit of the traditional industries in Taiwan, we also found that the actual situation of traditional industries that use digital media technology development applications as demonstration project for improved.

#### IV. Expected results

This project will be industry-university cooperative research and development, the required manpower by both sides participate, by the execution of this plan both industrial design technology capability and personnel training effect can achieve at the same time. Through this research and development, both sides can be found many key technologies which will vary beneficial to the future research and development.

1. With game industry's most popular game development engine Unity3, applied to the development of website to build a full 3D virtual temple website and open digital media design application of precedent in the temple culture.
2. By building full 3D mode interactive website, open religious and cultural use of digital media design to carry forward the human spirit, to change the general public in the mode of traditional religious and cultural beliefs habits and help the groups that inconvenient actual religion to the temple but need of sustenance, such as: the disabled, busy office workers.
3. To creative cultural and creative product marketing channels with website, combined with religious cultural spirit of the cultural and creative products to development cultural and creative new market.
4. Will combined School education and religious culture through industry-university cooperation, injection humanistic and moral spirit for the internet media to construct positive health network society.
5. The finished website will continue to permanently open and recommended to the



various religious institutions in order to develop more mature website products.

Build "3D virtual temple website "entities website model, and actually on line open access, build of this site, get traditional religious spirit through digitization techniques, technologies and features to do alternative promotional. Through the Internet far-reaching, Taiwan's religious propaganda to the world also let the medium of digital media to increase the cultural connotation, Technology always comes in humanity (Nokia) make the cold digital website humanity has a new digital life. It will be line with needs of the general public with gameplay and educational works of cultural and creative industries.

While this project is completed, the website will be permanently open and plan to be extended to others units which interested in developing online temple websites. Taiwan temple culture through build the full 3D virtual website and bring into rich educational games design, develop Taiwan human spirit so that digital media design emphasis on the spirit of innovation and development industry, make the essence of traditional religious culture has more innovative, interesting and high acceptance, let the busy modern spiritual exchange at any time and adjust physical, mental and spirit.

1. Will Continued to construct the network of religious and cultural world, play the Internet far and wide the spirit of spread.

2. It can be a reference for the game industry to develop a new game category and development more positive educational games.

3. Estimated the innovative design of this website will attract cultural and creative industries through the development possibilities of the online channel, this website is also kind of game website, the game industry is booming which bring business opportunities are infinite, with this project through this innovative the religious propaganda tactics, author believe that some other cultural and creative career can be created on this platform.

In addition, recommended this website as project templates to the county and city Department of Cultural Affairs, apply for build the local famous monuments temples and also for cultural digital archives extension, monuments promotion, digital archives, protection of its tangible benefits.

## V. References

1. 「FLASH 3D Effects Transnet, Green Milk Tea, Flag Publishing Co., Ltd.

2. PV3D Principle , <http://www.5uflash.com/flashjiaocheng/flash-3d/5450.html>
3. 3D Space 720 degree Video surround system, Three-dimensional official website [www.3dspace.com.tw/3dspace/index.php](http://www.3dspace.com.tw/3dspace/index.php)
4. Unity 3D Official Website - Unity3d.Com
5. Second Life Official Community Website - Sceondlife.Com
6. The game can start making money - Second Life, Commonwealth Magazine <http://www.cw.com.tw/article/index.jsp?id=2932>
7. Mirax Technology Corp Official Website [www.mirax.com.tw](http://www.mirax.com.tw)
8. 「Unity3D College of game development and design」 Ding Yu feng 、Wha Jie Creative Technology Ltd., GrandTech C.G. Systems Inc.
9. Wikipedia <http://zh.wikipedia.org/zh-tw/Wikipedia:%E9%A6%96%E9%A1%B5>
10. Second Life - Mood ChinaNetCenter <http://villamood.com/>

*The Indonesian Moslem Marital Quality Scale: Development, Validation, and Reliability*

Hepi Wahyuningsih\*<sup>1</sup>, Sartini Nuryoto\*<sup>2</sup>, Tina Afiatin\*<sup>2</sup>, Avin Helmi\*<sup>2</sup>

\*<sup>1</sup>Islamic University of Indonesia, Indonesia, \*<sup>2</sup>Gadjah Mada University, Indonesia

0410

The Asian Conference on Psychology & the Behavioral Sciences 2013

Official Conference Proceedings 2013



iafor

iafor  
The International Academic Forum  
[www.iafor.org](http://www.iafor.org)

The development of the Indonesian Moslem Marital Quality Scale (IMMQS) is presented. In the first study, data from 258 respondents were subjected to an exploratory factor analysis. Exploratory factor analysis uncovered 3 factors: friendship, harmony, and satisfaction with child. In the second study, data from 370 respondents were subjected to a confirmatory factor analysis, which provided support for the factor structure derived from the first study. Additional evidence of IMMQS reliability was also found. Implications for future directions for research are also discussed.

*Keywords:* marital quality, collectivism, exploratory factor analysis, multi-group confirmatory factor analysis

Marriage is the most important institution for people who are very different from other social institutions, especially in terms of duration, intensity, and function (Lasswell and Lasswell, 1987). The institution of marriage has an important function for the community. As mentioned in the Marriage Act No.1 year 1974 Chapter IV section 30 that the husband and wife have an obligation to enforce the household for the basic joint of societal structure (Walgito, 2004).

Spanier (Young, 2004) suggests that the functioning of marriage can be seen from two things, that is: marital quality and marital stability. In family studies, marital quality received considerable attention from researchers because of the research that has been conducted shows marital quality promoting the achievement of mental health (Cohen, Geron, and Farchi, 2009; Proulx, Helms and Buehler, 2007) and physical health (Umberson, Williams, Powers, Liu and Needham, 2006; Wickrama, Lorenz, Conger and Elder, 1997). Marital quality is also found as a deterrent to the domestic problems such as domestic violence (Byrne and Arias, 1997; Stith, Green, Smith and Ward, 2008), infidelity (Previti and Amato, 2004; Shackelford, Besser and Goetz, 2008; Susilawati and Suciptawati, 2005; Thompson, 1983), and divorce (Hirschberger, Srivastava, Marsh, Cowan and Cowan, 2009; White and Booth, 1991).

Marital quality was found to correlate positively with children's ability to establish relationships with peers (David, 2009; Forehand, Long, Brody and Fauber, 1986; Gottman and Katz, 1989). Other research suggests marital quality is negatively correlated with child behavior problems (Benzies, Harrison and Magill-Evans, 2004; Chang, Lansford, Schwartz and Farver, 2004; Emery and O'Leary, 1984; Parke, Leidy, Coltrane and Duffy, 2009) and emotional problems of child (Fishman and Meyers, 2000; Peleg-Popko and Dar, 2001). In addition, the poor marital quality is also one of the causes of child abuse. Mollerstrom, Patchner and Milner (1992) found a negative correlation between marital qualities with child abuse. Longitudinal study conducted by DiLillo, Peugh, Kate, Jillian, Emily and Sarah (2009) found the effect of marital quality on child abuse.

The results of these studies indicate an important role of marital quality on mental health. Thus, research on marital quality is important, but marital quality has conceptual weaknesses (Chung, 1990; Crane, Allgood, Larson and Friffin, 1990; Fincham, Beach and Kemp-Fincham, 1997; Glenn, 1990). Johnson, White, Edwards and Booth (1986) describes marital quality as an umbrella term for marital adjustments, marital satisfaction, marital happiness, marital interaction, marital disagreement, and the propensity to divorce. Another opinion says that marital quality, marital adjustment, and marital satisfaction often used interchangeable (Harper,

Schaalje and Sandberg, 2000). The same thing also expressed by Fincham and Rogge (2010) that marital quality, marital satisfaction, marital adjustment, marital success, and friendship are often used interchangeably, but in fact all of them reflect relationship quality.

According to Glenn (1990), the opinions on the concept of marital quality can be classified into two groups. The first group is the group that conceptualized marital quality as a multidimensional concept, while the second group is the group that conceptualized marital quality as a unidimensional concept. Spanier (1976) is one researcher who suggests that marital quality is a multidimensional concept that consists of four dimensions of marital quality, namely: satisfaction, consensus, cohesion, and expressions of love. In line with the opinion of Spanier (1976), Snyder (1979) also suggested that marital quality is a multidimensional concept that describes the interaction of marriage in 10 areas, namely: global distress, affective communication, communication, problem solving, time with, disagreement about finances, sexual dissatisfaction, role orientation, family history associated with distress, dissatisfaction with child, and conflicts related to parenting. Fowers and Olson (1989) argue that there are many sides to attach the marital relationship and each contributes to the quality of the marriage. There are 10 critical areas that contribute to the quality of marriage, namely: identity, communication, conflict resolution, financial management, leisure, sex, child and parenting, family and friends, equalitarian roles, religious orientation, marital cohesion, and marital changes.

Marital quality is a multidimensional concept has been criticized by some researchers. According to them, the concept of multidimensional has conceptual problems due to overlap with interpersonal processes in marriage which is actually an antecedent of marital quality (Bradbury, Fincham and Beach, 2000; Hendrick, 1988; Norton, 1983; Sabatelli, 1984). Fincham and Rogge (2010) also prefer to use the concept of marital quality is unidimensional, the subjective evaluation of the individual as a whole about the marriage relationship. Further Fincham and Rogge (2010) explain that the unidimensional concept has a clear interpretation allowing direct antecedents testing, correlation and consequences of marital relationship quality.

The opinion that the quality of the marriage is a unidimensional concept drew criticism from Fowers and Owenz (2010). According Fowers and Owenz (2010), the concept of marital quality is a unidimensional concept has simplified the concept of marital quality is in fact a complex concept. Further Fowers and Owenz (2010) argues that the concept of marital quality that only reveal what is perceived by the individual regarding his marriage has been ruled out marriage aimed at giving meaning to the individual.

Fowers and Owenz (2010) then argued that marriage is an activity in pursuit of a goal to be the criteria for determining the level of marital quality. High levels of marital quality can only be achieved when the individual has a goal of marriage which has the dimensions of constitutive goals and shared goal. Walgito (2004) suggested that marriage consists of two persons, there is a possibility between the two objectives are not the same. Goals should be rounded so that there is a unity of goal.

According Fowers and Owenz (2010), the purpose of marriage which has the dimensions of the constitutive goals and shared goals can be determined by a large

family, culture and religion. Thus, according to Fowers and Owenz (2010), to determine the criteria of marital quality required idiographic study on the subject to be studied. Based on suggestions Fowers and Owenz (2010), Wahyuningsih (2012) conducted an exploratory study in order to reveal the criteria of marital quality in accordance with the culture of the place doing research. Exploratory study conducted on four couples who are Muslim and the marriage is already over 25 years old. The results showed there are three marital quality criteria, namely: friendship, harmony, and satisfaction with the child.

It can be concluded that the opinions on the concept of marital quality in general can be divided into two groups, that is multidimensional and unidimensional concept. In this study, marital quality is a multidimensional concept because the unidimensional concept is too simplified of marital quality as a feeling of satisfaction or dissatisfaction with the marriage. Nevertheless, multidimensional concept that has been presented by some experts also have disadvantages because it also includes the factors that affect the marital quality such as personality, conflict resolution, role orientation, religious orientation, communication, parenting and family background. Therefore, researchers prefer to use the concept of marital quality of the results of research conducted by Wahyuningsih (2012), namely: friendship, harmony, and satisfaction with the child. Research to be conducted is aimed at developing construct validity of marital quality with Indonesian cultural backgrounds, particularly the Islamic religious background embraced by the majority of the Indonesian population.

### **Studi 1: Scale development and exploratory factor analysis**

#### **Study Purpose**

The purpose of study 1 was to develop items for the IMM QS that reflected the construct of marital quality and to investigate the factor structure of those items.

#### **Method**

##### **Participants**

The sample for this study consisted of 258 Moslem married people (131 husbands and 127 wives). Most of them are Javanese people.

##### **Procedure**

**Scale development.** For the purposes of the new measure, marital quality is defined as an evaluation of his/her marriage by using goal of marriage as objective evaluation criteria (Fowers and Owenz, 2010). IMM QS based on three criteria marital quality that found in preliminary studies (Wahyuningsih, 2012), that is: friendship, harmony, and satisfaction with children. An initial pool of 30 items was then generated by the team for content validity. Content validity was conducted by Content Validity Ratio (CVR—Lawshe, 1975). Testing content validity by using CVR produces 24 items. A total of 24 items were generated to reflect each of the three marital quality criteria, that is: friendship (7 items), harmony (8 items), and satisfaction with children (9 items). Items are rated on a 4-point Likert-type scale ranging from very appropriate (1) to very not appropriate (4).

**Data analysis.** According to Netemeyer, Bearden and Sharma (2003), there are two types of analysis methods that are often used by researchers when conducting exploratory factor analysis, it is the principle component analysis (PCA) and



exploratory factor analysis / common factor analysis / principle axis analysis (EFA). According Fabrigar, Wegener, MacCallum and Strahan (1999), where researchers aim to reduce the number of aitem and maximize the variance that can be explained by the measuring instruments (total variance explained), the researchers simply use PCA method. Further Fabrigar et al (1999) suggested that if the goal of the researchers wanted to investigate the factors underlying a construct of a measuring instrument and simultaneously reduce the amount aitem, then researchers should use the EFA.

Exploratory factor analysis method to be used in this study is the EFA (common factor analysis / principal axis factoring) with varimax orthogonal rotation because this study aims to test the model in which includes testing the theoretical constructs of each construct / latent variables used in this study. According to Floyd and Widaman (1995), when researchers will then forward the results of exploratory factor analysis to confirmatory factor analysis, the results of the factor analysis EFA method will be more successful than the tested results of the factor analysis with PCA method. Reliability analyses were then conducted to examine the internal consistency of the resulting subscales.

## **Results and Discussion**

### **Exploratory Factor analysis**

According to Costello and Osborne (2005), exploratory factor analysis can be said to fit when it has received a clean factor structure. The structure factor can be cleared if: (1) the value of item factor loading above 0.3, (2) there is no or little item cross-loading, and (3) there are at least three item in each factor. Further Costello & Osborne (2005) explains that in order to obtain a clean factor structure, researchers can manipulate the number of factors. If not clean factor structure by manipulating the number of factors, it may be possible to dispense item-item aitem problematic as having a low value of load factor or item-item that have cross-loading. The number of factor to be extracted was then determined by (a) eigenvalues above 1.0 (Kaiser, 1960), (b) Cattell's scree test (Cattell, 1966), and (c) the scree plot (Zwick & Velicer, 1986).

Based on those opinions, three factor solutions was chosen. The significance of Bartlett's test of sphericity ( $< 0,001$ ) and the size of the Kaiser-Meyer-Olkin measure of sampling adequacy (.87) revealed that the set of IMM QS items had adequate common variance for factor analysis (Tabachnick & Fidell, 1996). Three factors had eigenvalues greater than 1.0. Together, they accounted for 52.589% of the variance. The first factor (eigenvalue = 3.278) accounted for 25.213% of the variance; its factor loadings ranged from .565 to .70 (7 items). This factor and subscale was labeled friendship. The second factor (eigenvalue = 2.082) accounted for 16.018% of the variance; its factor loadings ranged from .701 to .808 (3 items). This factor and subscale was labeled satisfaction with children. The third factor (eigenvalue = 1.477) accounted for 11.358% of the variance; its factor loadings ranged from .515 to .806 (3 items). This factor and subscale was labeled harmony. Item factor loadings, as well as the variance explained by the item in the factor, are presented in Table 1.

Table 1  
Item Analysis and Internal Reliability for the Indonesian Moslem Marital Quality Scale

Item	Factor Loading			Item- total Correlati on	M	SD
	1	2	3			
Me and my spouse always help each other in educating children	.700			.641	3.50	.553
Me and my spouse have an agreement on how to interact with an extended family	.645			.574	3.24	.600
Me and my spouse have agreed on how to hang out with friends	.635			.511	3.22	.598
Me and my spouse have an agreement in spending money	.610			.580	3.28	.603
Me and my spouse have an agreement in educating children	.609			.645	3.46	.551
Me and my spouse solve problems together	.588			.654	3.50	.613
Me and my spouse often do activities together	.565			.568	3.27	.701
I am satisfied with the progress made by my child		.808		.514	3.32	.606
I am satisfied with the advantages possessed my child		.765		.444	3.33	.608
I am satisfied with the achievements my child		.701		.431	3.26	.682
Me and my spouse rarely fight			.806	.412	3.13	.635
Differences of opinion between me and my spouse does not cause strife			.584	.544	3.15	.649
Me and my spouse more often get along than fight			.515	.586	3.45	.558
Eigenvalue	3.278	2.082	1.477			
% of variance	25.21	16.01	11.35			
	3	8	8			
Numbers of item	7	3	3			

Note 1 = friendship; 2 = satisfaction with the child; 3 = harmony

### Internal consistency reliability evidence for IMMQS

The internal consistency reliabilities (coefficient alpha) .848 for friendship subscale, .824 for satisfaction with children subscale, and .761 for harmony subscale. For each subscale, corrected item-total correlations were all above .30.

### Studi 2: Further Examination of Factor Structure and Reliability

#### Study purpose

The primary purpose of study 2 was to examine the stability of the factor structure obtained in study 1. A secondary purpose was to examine IMMQS's reliability.

## **Method**

### **Participants**

They are 370 moslem married people (185 Moslem married couples). Cultural background of most of them are Javanese (husbands = 93.5%; wives = 93.5%). Marriage duration ranged from 1 to 38 years ( $M = 14.26$  years). Ages ranged from 23 to 68 old years ( $M = 40.01$  years) for husbands and 23 to 58 old years ( $M = 36.91$  years) for wives. Most of them have 2 children (42.7%) and the high school educated (husbands = 47.6%; wives = 50.3%). Husbands who works there is 99.05%, while wives worked only 51.4%.

### **Measure**

The 13-item IMMQS, discussed in study 1, was used in study 2. Internal reliability (coefficient alpha) .848 for friendship subscale (7 items), .824 for satisfaction with children subscale (3 items), and .761 for harmony subscale (3 items).

### **Data analysis**

Structural Equation Modeling (SEM) was employed to analyze the data in this study by using AMOS 20 (Arbuckle, 2011). The present study used second-order confirmatory factor analysis. Multigroup confirmatory factor analysis was used to test the invariance of structure across gender. Goodness-fit-indexes used in the present study included CFI and RMSEA (Byrne, 2010). In the equivalence test, there are two criteria that can be used, ie using  $\Delta$  chi-square and  $\Delta$  CFI (Byrne, 2010). According to Cheung and Rensvold (Byrne, 2010), to test the equivalence would be more realistic if it refers to the value of  $\Delta$ CFI than  $\Delta$  chi-square.

### **Reliability**

Based on literature studies, Widhiarso (2009) argued that most researcher in the field of psychology when estimating reliability using Cronbach alpha coefficient. Whereas Cronbach alpha coefficient has a certain criteria in order to have accurate estimates. One of the criteria that must be met is unidimensional data, therefore, according to Widhiarso (2009), researcher first need to identify the underlying constructs measuring instruments used. If the measuring instrument is based multidimensional construct, it would be more accurate if the estimated reliability multidimensional.

Widhiarso (2009) further argues that in order to ascertain whether a measure is unidimensional or multidimensional, researchers can conduct factor analysis before estimating the reliability of measuring instruments used. If the identification results showed unidimensional, then it can use in estimating the reliability of Cronbach alpha, Spearman-Brown, or KR-20. If the identification results show multidimensional data, then it should use in estimating the reliability of multidimensional reliability. Based on the information needed to calculate the reliability of multidimensional, reliability can be divided into two, namely reliability must be preceded by a confirmatory factor analysis (such as McDonald construct reliability, maximal reliability, and composite reliability Raykov) and which does not require factor analysis (such as stratified Cronbach alpha reliability). This study will use the maximum reliability as previous confirmatory factor analysis to test the stability of the three factors of IMMQS. Maximum reliability of a modified form of reliability McDonald which is not able to accommodate different weights in each dimensions (Mueller & Hancock, 2008).

## Results and discussion

### Multigroup confirmatory factor analysis

The fit of the multigroup confirmatory factor analysis model was satisfactory (CFI = .924, RMSEA = .047). According to Browne and Cudeck (Byrne, 2010), RMSEA values < .05 indicate good fit. Meanwhile, according to MacCallum et al (Byrne, 2010; Kenny, 2011) RMSEA values of less than .01 indicates excellent, less than .05 indicates a good, less than .08 indicates moderate, between .08 to .10 showed considerable conformity between the model hypotheses with empirical data and RMSEA values > .10 indicate poor fit. According to Byrne (2010), CFI values between .90 - .95 showed the suitability of the medium and above .95 indicated good fit.

The results of multi-group confirmatory factor analysis of IMMQS show  $\Delta$ CFI at: measurement weight model = .002 (<.01), structural covariances model = .003 (<.01), and measurement residuals model = .003 (<.01). Multigroup confirmatory factor analysis supported the three factor structure, demonstrated the invariance of this structure across gender. According Byrne (2010), invariance identified when delta CFI ( $\Delta$ CFI) value < .01. Delta CFI ( $\Delta$ CFI) is the difference between the baseline models (unconstrained model) with a model of equality.

Estimated value of the correlation between friendship and harmony is  $r = .76$  ( $p < .001$ ), estimated value of the correlation between friendship and satisfaction with children is  $r = .43$  ( $p < .001$ ) and estimated value of the correlation between harmony and satisfaction with children is  $r = .31$  ( $p < .01$ ). Estimated value of these correlations indicated IMMQS has good discriminant validity. According Kenny (2012), the correlation between two factors is or is very close to one or minus one indicated poor discriminant validity. A correlation of .85 or larger in absolute value indicates poor discriminant validity.

Range of factor loadings from .56 to .83 indicates IMMQS has good convergent validity. According Ghazali (2008), convergent validity in a confirmatory factor analysis can be seen from the value of factor loading. High factor loading values on one factor showed that they converge on a single point. Therefore, the charge could be significant factors lower the value, the standardized factor loading estimates should be equal to .50 or more and ideally should be .70. Meanwhile, according to Brown (2006), the value of factor loading above .3 or .40 in the study also has to be considered good. The results of multi-group confirmatory factor analysis of IMMQS can be seen in Figure 1.

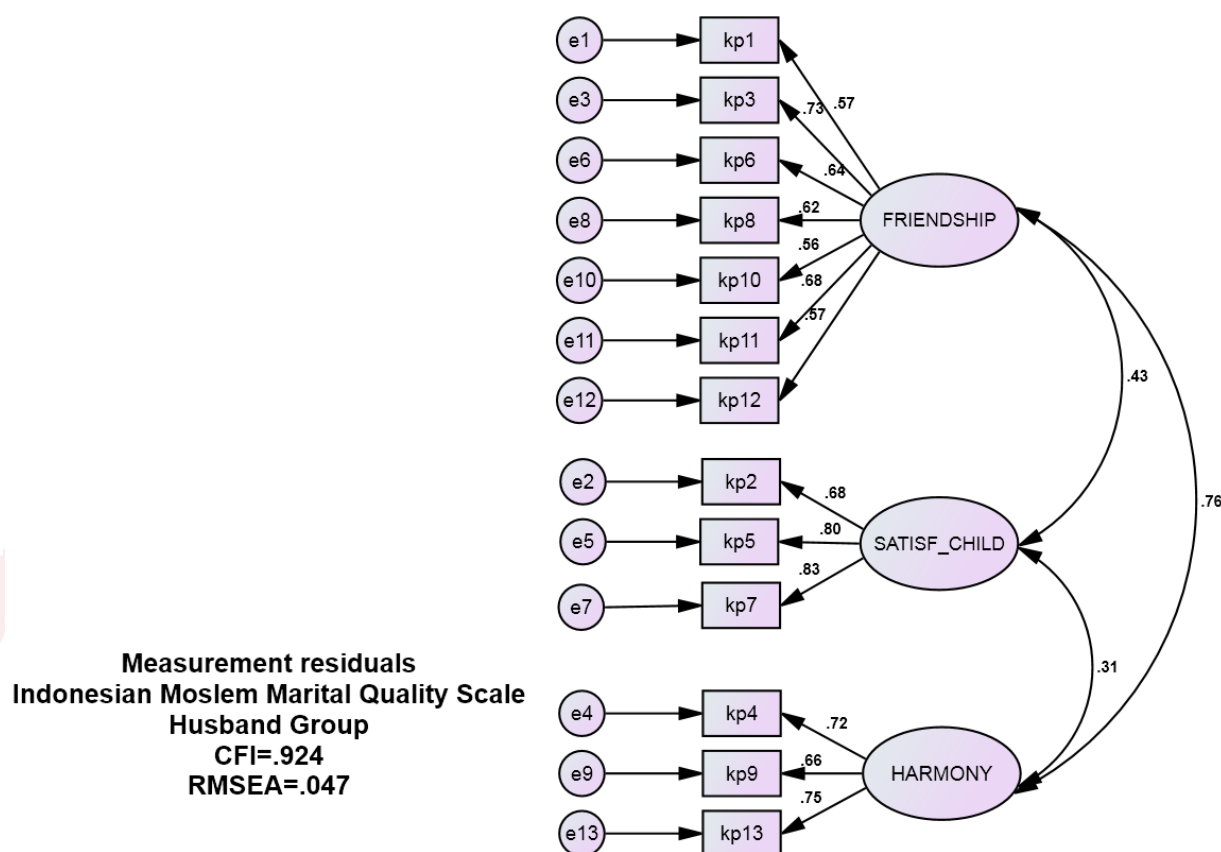

**Figure 1. The results of multi-group confirmatory factor analysis of IMM QS**

**Reliability**

Reliability of IMM QS then estimated by maximal reliability (Mueller & Hancock, 2008; Widhiarso, 2009). The estimates show IMM QS have a reliability coefficient of .927 in both husbands and wives.

**Summary and Overall Discussion**

The aim of the present research was to assess the factor structure and reliability of the IMM QS, a new measure of marital quality for Indonesian Moslem. The results of final EFA with varimax rotation revealed a 13-item IMM QS that reflected three subscales: the 7-item friendship, the 3-item satisfaction with children, and the 3-item harmony. Confirmatory factor analysis provided support for the factor structure derived from EFA.

EFA and CFA results support the results of an exploratory study conducted by Wahyuningsih (2012) who identified three criteria for marital quality, namely: friendship, harmony, and satisfaction with the child. This reinforces the opinion of Fowers and Owenz (2010) that the marital quality lately by researchers conceptualized as a unidimensional concept does not really reflect the actual reality of marital quality is a complex concept. According to Knapp and Holman (2010), this is because most researchers in conducting the study did not use a theoretical framework that researchers often characterize the marital quality taken for granted.



The study results also reinforce the idea Fowers and Owenz (2010) that marriage is an activity that has a goal, so that marriage has a high marital quality is a marriage that has the constitutive goal and shared goal in which these goals can be defined by religion. As stated by Wahyuningsih (2012) that marital quality criteria found in his research is closely related to the purpose of marriage in Islam is expressed by Al-Faruqi (1985).

This research still has its limitations. The first limitation is related to the subject of the study is limited to people who have children, so that future studies can do the same research with subjects who did not have children. The second limitation is related to the results of exploratory factor analysis in which there is some cross-loading items were removed. After scrutiny again, these items actually reflects the main purpose of marriage in Islam, which is serenity. This may indicate that the actual marital quality has a hierarchical structure. Thus in future studies, this measure need to be improved further in order to reflect the actual quality of the marriage is indeed a complex concept.

### References

- Al-Faruqi LLI (1985) Marriage in islam. *Journal of Ecumenical Studies* 22(1):55-68.
- Arbuckle JL (2011) *IBM® SPSS® Amos™ 20 User's Guide*. Chicago:Smallwaters.
- Benzies KM, Harrison MJ and Magill-Evans J (2004) Parenting stress, marital quality, and child behavior problems at age 7 years. *Public Health Nursing* 21(2): 111–121.
- Bradbury TN, Fincham FD and Beach SRH (2000) Research on the nature and determinants of marital satisfaction: a decade in review. *Journal of Marriage and the Family* 62(4): 964-980.
- Brown TA (2006) *Confirmatory Factor Analysis For Applied Research*. New York: The Guildford Press.
- Byrne BM (2010) *Structural Equation Modeling With Amos: Basic Concepts, Applications, And Programming*. New York: Routledge.
- Byrne CA and Arias I (1997) Marital satisfaction and marital violence: Moderating effects of attributional processes. *Journal of Family Psychology* 11(2): 188-195.
- Cattell JL (1966) The scree test for the number of factors. *Multivariate Behavioral Research*, 1: 245–276.
- Chang L, Lansford JE, Schwartz D and Farver JM (2004) Marital quality, maternal depressed affect, harsh parenting, and child externalising in Hong Kong Chinese families. *International Journal of Behavioral Development* 28(4): 311–318.
- Chung H (1990) Research on the marital relationship: A Critical review. *Family Science Review* 3(1):41-64.
- Cohen O, Geron Y, and Farchi A (2009) Marital quality and global well-being among older adult israeli couples in enduring marriages. *The American Journal of Family Therapy* 37(4): 299-317
- Costello AB and Osborne J (2005) Best practices in exploratory factor analysis: four recommendations for getting the most from your analysis. *Practical Assessment Research & Evaluation* (10)7: 1 - 9.
- Crane DR, Allgood SM, Larson JH and Friffin, W (1990) Assessing marital quality with distressed and nondistressed couples: A comparison and equivalency table for three frequently used measures. *Journal of Marriage and the Family* (5): 87-93.



- Davies JC (2011) Preserving the "us identity" through marriage commitment while living with early-stage dementia. *Dementia* 10(2): 217–234.
- DiLillo D, Peugh J, Kate W, Jillian P, Emily T and Sarah E (2009) Child maltreatment history among newlywed couples: A longitudinal study of marital outcomes and mediating pathways. *Journal of Consulting and Clinical Psychology* 77(4): 680-692.
- Emery RE and O'Leary KD (1984) Marital discord and child behavior problems in a nonclinic sample. *Journal of Abnormal Child Psychology* 12(3): 411-420.
- Fabrigar LR, Wegener DT, MacCallum RC and Strahan EJ (1999) Evaluating the use of exploratory factor analysis in psychological research. *Psychological Methods* 4(3): 272-299.
- Fincham FD and Beach SRH (2010). Marriage in the new millennium: A decade in review. *Journal of Marriage and Family* 72(3): 630 – 649.
- Fincham FD, Beach SRH and Kemp-Fincham S (1997) Marital quality: A new theoretical perspective. In RJ Sternberg & M Hojjat (Eds.) *Satisfaction In Close Relationships*. New York: Guilford Press.
- Fincham FD and Rogge R (2010) Understanding relationship quality: Theoretical challenges and new tools for assessment. *Journal of Family Theory & Review* 2: 227–242.
- Fishman EA and Meyers SA (2000) Marital satisfaction and child adjustment: Direct and mediated pathways. *Contemporary Family Therapy* 22(4): 437 – 452.
- Floyd FJ and Widaman KF (1995) Factor analysis in the development and refinement of clinical assessment instruments. *Psychological Assessment* 7(3): 286-299.
- Forehand R, Long N, Brody GH and Fauber R (1986). Home predictors of young adolescents school behavior and academic performance. *Child Development* 57(6): 1528-1533.
- Fowers BJ and Olson DH (1989) Enrich marital inventory: A discriminant validity and cross-validation assessment. *Journal of Marital and Family Therapy* 15(1): 65–79.
- Fowers BJ and Owenz MB (2010) A eudaimonic theory of marital quality. *Journal of Family Theory & Review* 2: 334–352.
- Ghozali I (2008) *Konsep dan Aplikasi dengan Program Amos 16.0*. Semarang: Badan Penerbit Universitas Diponegoro.
- Glenn ND (1990) Quantitative research on marital quality in the 1980s: A critical review. *Journal of Marriage And The Family* 52(4): 818 – 831.
- Gottman JM and Katz LF (1989) Effects of marital discord on young children's peer interaction and health. *Developmental Psychology* 25(3): 373-381.
- Harper JM, Schaalje BG and Sandberg JG (2000) Daily hassles, intimacy, and marital quality in later life marriage. *The American Journal Of Family Therapy* 28: 1-18
- Hendrick SS (1988) A generic measure of relationship satisfaction. *Journal of Marriage and Family* 50(1): 93-98.
- Hirschberger G, Srivastava S, Marsh P, Cowan, CP and Cowan PA (2009) Attachment, marital satisfaction, and divorce during the first fifteen years of parenthood. *Personal Relationship* 16(3): 401 – 420.
- Johnson DR, White LK, Edwards JN and Booth A (1986) Dimensions of marital quality: toward methodological and conceptual refinement. *Journal of Family Issues* 7(1): 31-49.
- Kaiser HF (1960) The application of electronic computers to factor analysis. *Educational and Psychological Measurement* 20: 141–151.

- Knapp SJ and Holman TB (2010) Introducing a special issue: On the need to theorize marital quality. *Journal of Family Theory & Review* 2: 221–226.
- Kenny DA (2011) Measuring model Fit. Available at: <http://davidakenny.net/cm/fit.htm>
- Kenny DA (2012) Multiple factor models: Confirmatory factor analysis. Available at: <http://davidakenny.net/cm/mfactor.htm>
- Lasswell M and Lasswell T (1987) *Marriage And The Family*. California: Woodsworth, Inc
- Lawshe CH (1975) A quatitative approach to content validity. *Personnel Psychology* 28: 563 – 575.
- Mollerstrom WW, Patchner MA and Milner JS (1992) Family functioning and child abuse potential. *Journal of Clinical Psychology* 48(4): 445 – 454.
- Mueller RO and Hancock GR (2008) Best practices in structural equation modeling. In JW Osborne (Ed.) *Best Practices in Quantitative Methods*. Thousand Oaks, CA: Sage Publications, Inc, 488 – 508.
- Netemeyer RG, Bearden WO and Sharma S (2003). *Scaling Procedures: Issues and Applications*. London: Sage Publications.
- Norton R (1983) Measuring marital quality: A Critical look at the dependent variable. *Journal of Marriage and the Family* 45(1): 141-151.
- Parke RD, Leidy MS, Coltrane S and Duffy S (2009) Positive marital quality, acculturative stress, and child outcomes among Mexican Americans. *Journal of Marriage and Family* 71: 833 – 847
- Peleg-Popko O and Dar R (2001) Marital quality, family patterns, and children’s fear and social anxiety. *Contemporary Family Therapy* 23(4): 465–487.
- Previti D and Amato PR (2004) Is infidelity a cause or a consequence of poor marital quality? *Journal of Social and Personal Relationships* 21(2): 217-230.
- Proulx CM, Helms HM and Buehler C (2007) Marital quality and personal well-being: A meta-analysis. *Journal of Marriage and Family* 69(3): 576–593.
- Sabatelli RM (1984) The Marital Comparison level index: A Measure for assessing outcomes relative to expectation. *Journal of Marriage and the Family* 46(3): 651-662.
- Shackelford TK, Besser A and Goetz AT (2008) *Individual Differences Research* 6 (1): 13-25.
- Snarey JR and Dollahite DC (2001) Varieties of religion-family linkages. *Journal of Family Psychology* 15(4): 646-651.
- Spanier GB (1976) Measuring dyadic adjustment: New scales for assessing the quality of marriage and similar dyads. *Journal of Marriage and Family* 38(1): 15-28.
- Stith SM, Green NM, Smith DB and Ward DB (2008) Marital satisfaction and marital discord as risk markers for intimate partner violence: A Meta-analytic review. *Journal of Family Violence* 23(3): 149-160.
- Susilawati M and Suciptawati NP (2005) Persepsi wanita terhadap perselingkuhan. *Jurnal Penelitian* 1(17):753-767.
- Tabachnick BG and Fidell LS (1996) *Using Multivariate Statistics (3rd Ed)* New York: HarperCollins.
- Thompson AP (1983) Extramarital sex: A review of the research literature. *Journal of Sex Research* 19(1): 1-22.
- Umberson D, Williams K, Powers DA, Liu H and Needham B (2006) You make me sick: Marital quality and health over the life course. *Journal of Health and Social Behavior* 47(1) 1-16.

- Wahyuningsih H (2012) Faktor-Faktor Penentu Kualitas Perkawinan (Studi Eksplorasi Kualitas Perkawinan Pada Pasangan Muslim). In Widodo B, Setya W, Jaka S, Sarwidi and Widodo (eds) *Menuju Masyarakat Madani dan Lestari Prosiding Seminar Nasional*, Yogyakarta: Universitas Islam Indonesia, 53-66.
- Walgito B (2004) *Bimbingan Dan konseling perkawinan*. Yogyakarta: Andi Offset
- White LK and Booth A (1991) Divorce over the life course the role of marital happiness. *Journal of Family Issues* 12 (1): 5-21.
- Wickrama, Lorenz FO, Conger RD and ElderGH (1997) Marital quality and physical illness: A latent growth curve analysis. *Journal of Marriage and Family* 59(1): 143-155.
- Widhiarso W (2009) Koefisien reliabilitas pada pengukuran kepribadian yang bersifat multidimensi. *Psikobuana* 1(1): 39-48.
- Young MA (2004) Healthy relationships: Where's the research? *The Family Journal* 12 (2): 159-162.
- Zwick WR and Velicer WF (1986) Comparison of five rules for determining the number of components to retain. *Psychological Bulletin* 99 (3): 432-442.

The logo for 'iafor' is centered on the page. It consists of the lowercase letters 'iafor' in a light blue, sans-serif font. The logo is partially enclosed by two large, overlapping circular arcs: a light blue arc at the bottom and a light red arc on the left side.

*Learn to Cope with Hypoglycemia in Patients with Diabetes*

Fei Ling Wu

Chang Gung University of Science and Technology, Taiwan

0411

The Asian Conference on Psychology & the Behavioral Sciences 2013

Official Conference Proceedings 2013

Abstract

**Background:** The fear of hypoglycemia may be an important barrier to people adopting regimens that closely control blood glucose levels and decrease long-term complications. To develop patient-centered education for people who experience hypoglycemia an understanding of their experiences with hypoglycemia is needed.

**Objectives:** The aim of this study was to explore people with diabetes experience of having a hypoglycemic episode from the social problem solving perspective to understand problem-solving participants make about self-management.

**Methods:** Design: The qualitative study using semi structured interviews.

Settings: Participants were recruited from two study sites in northern Taiwan. One site was a small urban public health clinic and the other site was a large teaching hospital.

Participants: The study population consisted of 21 participants treated with insulin and with hypoglycemic episodes in previous 3 months.

Methods: Semi-structured interviews were conducted from July 2009 to January 2010. Data were analyzed using qualitative content analysis. Open-coding methods were used to identify common concepts among participants. Common concepts were grouped into categories with similar properties and dimensions. The categories to develop themes based on the problem-solving theory.

Results: Findings are presented according to components of the social problem solving theory: problem orientation, identity cause of hypoglycemic problem, goal setting, generation and implementation of solutions, and verification that emerged on the Social Problem-Solving Model.

Conclusions: This study can help health care professionals and researchers develop educational programs to improve hypoglycemia self-management. Enhancing hypoglycemic control skills in patients whose current skills are not effective may promote a positive problem orientation.

Key words: Diabetes mellitus, Self management, Hypoglycemia, Social problem solving

iafor  
The International Academic Forum  
[www.iafor.org](http://www.iafor.org)

## A Literature Review: Bilingualism Helps Asian Families Flourish

Some first or second generation Asian immigrants choose to teach and immerse their children in their native language, while others choose not to. This literature review investigates some possible reasons behind this decision. The advantages of immersing children in their first language will be discussed. To present a balance, it is important to present the disadvantages of doing so. In addition, the disproportionate number of advantages versus disadvantages, as evidenced by the literature, will be highlighted. For the purpose of this paper, native language is defined as the first language spoken by parents, other than English. Furthermore, references to culture will be specifically to ethnic culture. By the end of this paper, I hope to present that it would be beneficial for Asian immigrants to immerse their children in their native language due to the significant cultural and cognitive benefits this would harvest.

### Advantages of Immersing Children in a Native Language

#### The Cultural Perspective

When immigrants come to Canada, they have to make a decision regarding the extent to which they wish to preserve their distinct cultural uniqueness (Arthur, Merali, & Djuraskovic, 2010). In addition, they need to decide how much they want to connect with others who do not share their cultural traditions. In this section, the positive cultural benefits of immersing children in a native language will be explored. One such benefit is that it may make the acculturation process of family members go more smoothly (Boutakidis, Chao, & Rodriguez, 2011; Costigan & Dokis, 2006). By being familiar with one's native language, it may help one remain bicultural (Costigan & Dokis; Kim & Omizo, 2006; LaFromboise, Coleman, & Gerton, 1993). The ability of speaking the family's native tongue, may aid one to connect more deeply with their ethnic culture (Boutakidis et al; Costigan & Dokis). It may also assist in reducing the generational gap experienced by immigrant families (Costigan & Dokis, 2006; Boutakidis et al., 2011; Wu & Chao, 2011).

**The process of acculturation.** Some immigrants may be more acculturated (Berry, 2005); whereas others may be slower to adapt to the greater culture. Berry defined acculturation as, "the dual process of cultural and psychological change that takes place as a result of contact between two or more cultural groups and their individual members" (p. 698). In other words, acculturation involves the progression of how one becomes comfortable with living in a new and foreign environment. The rate of acculturation is different for each individual and each family who immigrates. Costigan and Dokis (2006) found that immigrants who settle in Canada generally fair well. In this study, families were drawn from the community and acculturation was measured with independent results from parents and children. In general, the child participants reported low intensities of struggles, low depressive indicators, and high achievement incentive. This occurred despite different experiences of acculturation compared to their parents. Furthermore, immersing children in their native language strengthened the bond of the family. For instance, when children adjust to the Canadian culture at a faster rate, their parents may feel they are losing their ethnic



identity. However, with the common spoken language of Chinese, they are able to share a more collective experience, regardless of the rate of acculturation (Boutakidis et al., 2011).

**The bicultural experience.** Biculturalism is, “the integration of the home and host cultures in terms of both lifestyles and interaction patterns” (Arthur et al., 2010, p. 289); the aim is to remain in the midpoint between isolation from other groups, and complete assimilation into the greater culture. Therefore, when Asian immigrants immerse their children in their native language, whilst continuing to encourage them to learn English, it could create an optimal balance. As mentioned above, Costigan and Dokis (2006) conducted a study of immigrant Chinese families; they wanted to find the relationship between parent and child rates of acculturation, and individual and family adjustment in the host country. Results of the study indicated that it is vital to offer programs to uphold immigrant children’s sustained participation in their ethnic culture, while, at the same time, they also attain the skills needed to blossom in the new country.

In addition, Kim and Omizo (2006) voiced that developing an affirmative Asian American identity is connected to engaging in Asian behavioural norms. This includes the use of the Asian language. Furthermore, they also suggested that Asian Americans should participate in European American norms to remain bicultural. Consequently, LaFromboise and colleagues (1993) concurred that it is essential to hold both cultural groups in a positive light. They relayed that, without positive views about both groups, one may be inhibited by the ability to feel good about interacting with both cultures. In essence, the teaching of a native language to preserve the ethnic culture, and the encouragement of learning English, allows children to appreciate both cultures.

**The sense of connection.** There are many words in Chinese that are not equivalent in English. When one speaks English with a parent, the connection is not as profound, as there are many ways he or she is not expressing the exact sentiment. A study conducted by Boutakidis and colleagues (2011) agreed with this assertion. They found that Chinese and Korean adolescents, who were able to communicate with their parents in their native language, had a better understanding of their native culture. This is because they were, “able to understand and express these values within the cultural and linguistic context in which they originated, further aiding their understanding of the parent’s values and perceptions” (Boutakidis et al., p. 130 ). In this light, language is more than a medium of communication; it offers a deeper level of sharing within a culture.

Moreover, when parents and children are able to share their native language, the process of learning about their customs and traditions become more ingrained. Costigan and Dokis (2006) relayed that when mothers speak Chinese, and the children do not, their difficulties in communicating with each other, make it challenging to share emotional concerns. On the other hand, children who were more analogous to their mothers in adhering to the Chinese culture, such as showing a willingness to learn and speak Chinese, may experience more support in their families (Costigan & Dokis, 2006). Hence, this study emphasized the emotional benefits of being able to communicate in a native language.



**Minimizing the generational gap.** The benefits of being able to speak the native language may transpire into communicating more effectively with parents. As indicated above, Berry (2005) voiced that older and younger people may acculturate at different rates. For example, parents may lag behind their children in terms of getting acquainted with the host culture. A study conducted by Wu and Chao (2011) asked participants in grades 10 to 12 to complete a 50 minute questionnaire; this measured parental warmth, parental-adolescent open communication, Chinese parent-adolescent relationships, and adolescents' internalizing symptoms. The questionnaire was completed by 249 Chinese American (95 first-generation and 154 second-generation) adolescents and 385 European-American adolescents in the greater Los Angeles region. First-generation pertains to adolescents born outside of the United States to immigrant parents; and, second-generation pertains to adolescents born in the United States to immigrant parents. The results indicated that second-generation adolescents experienced higher levels of adjustment problems when they answered questions regarding parental warmth, when compared with European Americans. The difference was not indicative when comparing first-generation adolescents and European Americans. In addition, second-generation adolescents were more prone to experience internalizing symptoms.

Overall, there was a greater degree of cultural dissonance in the second-generation group, such as in parental warmth and open communication; there was also an increased rate of behavioural problems for these Chinese youth (Wu & Chao, 2011). For this group, greater discrepancies were associated with generational gaps encompassing two types of stress. These were, "acculturative pressures and normative generational gaps" (Wu & Chao, p. 503). As indicated above, when adolescents were able to share a common native language with their parents (Costigan and Dokis, 2006), and were able to communicate fluently in the native language, it was possible for the adolescent and the parent to share a collective sociocultural perspective (Boutakidis et al., 2011). In essence, more unity may be possible, and therefore decreases the generational gap experienced by adolescents. The benefits of teaching children a native language include the possibility of bringing the rates of acculturation closer for the parent and the child. It fosters the youth's biculturalism to a greater degree. In addition, the sense of connection becomes stronger. Furthermore, it may help to close up the generational gap experienced by many immigrant families.

### **The Cognitive Perspective**

In contrast to the early twentieth century (Hakuta & Garcia, 1989), there is presently an array of research that points to the cognitive benefits of bilingualism. First, bilinguals have more choice in language expression (Gollan & Ferreira, 2009; Rodriguez-Fornells, Balaguer, & Munte, 2006). Second, another benefit is that proficient bilinguals, ones who are equally as proficient in two languages, may perform above monolinguals in terms of mathematics and language classes (Kempert, Saalbach, & Hardy, 2011). Subsequently, they have higher functioning in executive control (Bialystok, Craik, & Luk, 2008; Kempert et al., 2011); which will be defined below. Lastly, their brains are more fit and may delay the onset of dementia (Adesope, Lavin, Thompson, & Ungerleider, 2010; Bialystok, et al., 2008; Mechelli et al., 2004).

**The bilingual brain has more choice.** Rodriguez-Fornells and colleagues (2006) found that fluent bilinguals interchange from one language to the other, and are able to isolate both languages entirely without much struggle. Later, Gollan and Ferreira (2009) agreed that knowing two languages offers advantages such as the ability to communicate to a wider audience, and function in a larger diversity of language situations. They also communicated that bilinguals have the power of choice when speaking with other bilinguals; they have the flexibility of selecting whichever language most straightforwardly and distinctively convey their thoughts. In essence, bilinguals enjoy more freedom of expression when it comes to language use.

**Proficient bilinguals have advantages in academics.** In Kempert and colleagues' (2011) study, they found that students of Turkish and German elementary bilingual schools had to keep two languages separate by recurrent usage and exposure. The students, who were proficient bilinguals, indicating that they were skillful in both languages, performed better in math problems with distractors, compared to students who were monolinguals. Furthermore, bilingual students were apt to have more attentional control than monolingual students. Positive attentional control involves the degree of flexibility in interchanging attention between, and within tasks to make the most out of performance (Derakshan & Eysenck, 2009). In Kempert et al.'s study, proficient bilinguals had higher scores compared to their monolinguals peers on these tasks. It may be significant to underscore the relationship between performing well in mathematics and also excelling in learning languages. Hence, Kempert and colleagues' study is an important one to note in regards to the benefits offered to proficient bilinguals.

**Bilinguals have higher executive control.** Furthermore, Kempert and colleagues (2011) found that bilingual children possess cognitive benefits such as executive control. Pessao (2009) defined executive control as a set of, "functions, typically believed to depend on the frontal cortex (and probably the parietal cortex), which are needed when non-routine behaviors are called for – namely, when 'control' is required" (p. 160). In other words, executive control provides one with the ability to set and reach goals, inhibit a tendency to do wrong, and keep focus when attention is needed (Hughes & Ensor, 2007). In Kempert et al.'s findings, even immigrant students with a weak grasp of the German language (language of instruction), performed at an equal level in executive control tasks compared to their monolingual peers. Therefore, even nonbalanced bilinguals (one's who are more proficient in one language compared to the other), profit from being bilingual.

In another study, Bialystok et al. (2008) also found that bilinguals performed better in tasks that require executive control compared to monolinguals. This study incorporated the Stroop task. Miller et al. (2001) indicated that the Stroop task incorporates, "asking the subjects to either read words or name the colour in which they were written" (p. 168). For example, if the word is green, however, is written in red, the reader would be asked to name the colour; this requires one to focus on only one attribute at a time. In Bialystok and colleagues' study, bilingual subjects fared better than monolingual subjects in these tasks. In combination with other tests, they were found to have higher executive control in general. Hence, both Kempert and colleagues' (2011) and Bialystok and colleagues' studies pointed toward the positive benefits in terms of having higher functioning in executive control tasks.

**The bilingual's brain is more fit.** Mechelli and colleagues (2004) indicated that when one learns a second language, the grey matter in the left inferior cortex becomes

bigger. This may help in the postponement of dementia for an average of four years. Furthermore, Bialystok and colleagues' (2008) study found that knowing two or more languages enhances the progress, as well as defers the decline, of executive control on a number of tasks; this was evident across the lifespan. Specifically these results were found in nonverbal tasks as well, which were not knowingly related to language processing.

In addition, Adesope et al. (2010) performed a meta-analysis research of 63 studies and found that balanced bilinguals were, "associated with several cognitive outcomes, including increased attentional control, working memory, metalinguistic awareness, and abstract and symbolic representation skills" (p. 207). Therefore, they exceeded monolinguals in metalinguistic and metacognitive awareness. In addition, in this project, attentional control was strongly correlated with bilingualism. Subsequently, Adesope and colleagues found that these advantages were present regardless of participants' socioeconomic status (SES). Therefore, the bilingual brain may benefit from being exercised beyond the ones that are only exposed to one language.

The bilingual brain has shown to be more flexible in that it may function in multiple language environments. In proficient bilinguals, they were found to perform more effectively in certain mathematical concepts. In regards to executive control tasks, bilinguals also outperformed monolinguals in certain tasks. Furthermore, being proficient in two or more languages may help suspend the arrival of dementia.

## **Disadvantages of Immersing Children in a Native Language**

### **The Cultural Perspective**

Although the cultural benefits are apparent, as presented earlier; still, some studies found some drawbacks of insisting children speak a native language (Costigan & Dokis, 2006; Hwang, Wood & Fujimoto, 2010). This includes that the parent and child may disagree on the value of retaining the language (Costigan & Dokis, 2006; Hwang et al., 2010). Young people may be self-conscious to speak it and fear being judged by people from the host culture (Weyant, 2007). When people from different ethnic cultural backgrounds unite and form a family, they may decide to only teach English to their children. (AhnAllen & Suyemoto, 2011; Hynie, Lalonde, & Lee, 2006; Mok, 1999).

**Differences in values.** Insisting children to speak a native language may cause rift in the family if the child resists doing so. Some young people may not see the value in keeping their native language. Hwang et al. (2010) introduced the term *acculturative family distancing* (AFD). This is the distancing that transpires among immigrant parents and their children; it is triggered by breakdowns in communication and cultural value differences. This may be due to the different degrees with which parents and children obtain characteristics of the host culture at different rates (Berry, 2005). This study indicated that larger numbers of youth and mothers reports of AFD were associated with higher depressive symptoms and risk for clinical depression. Therefore, enforcing the native language to be spoken may cause further distancing between the parent and child.

Furthermore, Costigan and Dokis (2006) relayed that when Chinese Canadian parents were more adamantly in favour of the Chinese culture and desired to speak Chinese, a decreased level of Chinese cultural and linguistic participation by the children was related to instability in the relationship. When parents and children do not assign the same value to learning and speaking Chinese, disagreements may ensue. In the long run, these disagreements may cause the family to be divided.

**Being self-conscious.** Children may not desire to speak a native language due to not wanting to digress from the host culture. The younger generation may feel that speaking a native language may not be the prevalent thing to do. Weyant's (2007) study found that participants favoured people who speak English without an accent. After listening to an audiotape of various speakers with different accents, they rated the pure English speaker higher in areas of ability and accomplishment. Hence, participants thought they were more intelligent than the speakers who spoke with an accent. Young people may pick up on this negative stigma and feel self-conscious about their native language. Therefore, when parents push too hard for them to learn and use the language, they may further resist doing so.

**Interracial relationships.** In unions in which one partner does not speak the language, the couple may choose not to teach their children one of the parent's native languages. This may be due to thinking that a language barrier between one parent and the children may be unfair. A study conducted by AhnAllen and Suyemoto (2011), found that when Asian women and White men date, they experience barriers such as reconciling how to communicate effectively, facing unacceptance by family members, and the weight of having to challenge racism. When marriage becomes a reality, it may be more difficult to navigate whether to teach children a native language, since one partner would not understand the language.

According to Costigan and Dokis' (2006) study mentioned earlier, Chinese women were more likely to teach language. Hence, when a Chinese man marries outside of his ethnic culture, the likelihood of preserving the native language may be lower. However, women may still have the tendency to immerse their children in the language, due to wanting to preserve the culture. In interracial relationships, the dynamics are different since one partner would not speak Chinese (AhnAllen & Suyemoto, 2011). Again, it becomes more challenging to decide whether to teach the Chinese language, out of consideration for the spouse who does not speak or understand it.

Furthermore, Hynie and colleagues (2006) study suggested that Chinese immigrant parents and children may be at odds with one another about their choice of partners. Parents in this study preferred their children to marry someone with traits related to the traditional family construction, function, and role. Subsequently, they wanted their daughters to marry someone with a higher status. Many children in this study aligned with their parent's views, and when this occurred, conflict was absent. In addition, Mok (1999) found that the probability of Asian Americans dating White Americans is partial to higher levels of acculturation rather than lower levels of ethnic identity. One may question, if an individual is more acculturated, then would he or she be less likely to appreciate their native language? Further studies may be needed to address this point. In essence, these studies speak to the conflict that may arise in



interracial families when deciding whether or not to introduce, teach, and immerse children in a native language.

In families where the parent speaks a native language, and is diligent in enforcing this spoken language to their children, the children may feel less need to comply, since mainly English is spoken in the host culture. This may cause conflict of interest in the family. Some young people may feel self-conscious when others hear them speak another language; they may feel that they are not blending in with the host culture. In addition, in interracial relationships, one partner may not want to enforce a native language due to not wanting to exclude the other partner.

### **The Cognitive Perspective**

Studies have also shown some cognitive drawbacks to bilingualism. Bilinguals who are more proficient in one language (dominant bilinguals) may lag behind their peers in the performance of lexical tasks (Bialystok et al., 2008; Gollan & Ferreria, 2009); of which will be defined below. When two languages differ in their linguistic structure, students may be more challenged to learn the language of instruction (Kempert et al., 2011; Yeong & Rickard Liow, 2011). The fluency of the chosen spoken language may also suffer (Gollan & Ferreria, 2005).

**Dominant bilingual children and lexical tasks.** Hakuta and Garcia (1989) proclaimed that in the early 1900s, the performance on standardized tests highly disfavoured bilingual children; bilingualism was interpreted as a mental burden that caused inferior levels of intellect. Over a century later, Bialystok and colleagues (2008) also found that bilinguals may fall behind monolinguals in lexical tasks including verbal fluency. These tasks include the Peabody Picture Vocabulary Test (PPVT), Boston naming task, and category fluency task from the verbal task battery. David E. Meyers and Roger Schvaneveldt worked together in the 1970s to determine whether lexical-decision tasks affect reaction times (RT) in cognition. It was found that, “lexical-decision RTs are significantly shorter for words (e.g., butter) immediately preceded by other associated words (e.g., bread)” (David E. Meyers, 2002, p. 833). In Bialystok and colleagues’ study, the subjects who were bilinguals were slower in these lexical-decision tasks compared to the monolinguals. In essence, lexical tasks have shown to be more challenging for bilinguals because both languages are active; this creates the need to attend and select during these tasks, thus decreasing retrieval time.

In fact, Gollan and Ferreira’s (2005) study demonstrated this specific retrieval time. For instance, they indicated that Spanish-English bilinguals, where English was usually the stronger language, named pictures in English at a slower rate than English monolinguals. This may have to do with needing to draw from a bank of two languages, thus, slowing down the retrieval time. Therefore, it is significant to note that dominant bilingual children may spend more time on lexical tasks.

### **Bilingual students may experience difficulty when two languages are dissimilar.**

Kempert and colleagues (2011) conveyed that, when ESL students have a weak understanding of the language taught in school, their academic success will be negatively affected. A six-month longitudinal study by Yeong and Rickard Liow (2011) can attest to this, as they found that children with Mandarin, as their first language, favoured syllable awareness as opposed to phoneme awareness. For

instance, in Mandarin, each character forms a word, and knowing each syllable, by memorization, helps in reading, whereas in English, children are encouraged to sound out the letters of the alphabet that form words (phoneme system); these differences are fundamental to note when teaching Mandarin-speaking students the English language. This aforementioned study incorporated 50 kindergarten participants, whereby English was their first language, and 50 kindergarten participants, whereby Mandarin was their first language. During the first trial, the children were administered the parallel version of the English and Mandarin tasks; subsequently, the second time around, their spelling intricacy scores were computed from a 52-item experimental task. Since English is phoneme-based, this makes it more difficult for the Mandarin speakers to learn to spell in English. This points to the importance of Chinese ESL learners being exposed to aural English in the early years, as opposed to children who have a grasp of language with a comparable linguistic organization, such as Spanish and French. In essence, one may decide to not teach children Mandarin due to this disadvantage during primary school age years.

**The fluency disadvantage.** Gollan and Ferreria (2009) found that bilinguals face the challenge of needing to choose to only speak one language when conversing with monolinguals or multilinguals (with different language combinations), although both languages may be useful to communicate the envisioned meaning. In this study, 73 Spanish-English undergraduate bilinguals contributed for course credit, the goal was to name as many pictures as possible, shown on a computer, without making mistakes. The Spanish group was allowed to name the pictures in Spanish only, the English group, in English only, and there was one group who was allowed to choose the language of choice. Results showed that bilinguals may have a more difficult time when needing to retrieve synonyms. Whereas a monolingual needs to access words for which may not be commonly spoken in everyday language usage, the bilingual has to do so with almost every word they speak because they have to completely eliminate one language when speaking the other. The cost of voluntarily switching from one language to another was substantial in that retrieval time was slower. In this light, bilinguals may have an obvious disadvantage, in terms of fluency, when required to only speak one specific language at a time.

Bilinguals, who are not balanced (more proficient in one language, compared to the other), have a more difficult time completing lexical tasks. Furthermore, when the native language, such as Mandarin, is completely different in syllabic and phonemic organization compared to English, the Mandarin speaker may lag behind in learning English. In addition, bilinguals may fall behind compared to monolinguals in terms of language fluency skills. Despite these drawbacks, in the next section, the reasons for the advantages to overshadow the disadvantages of teaching children a native language will be discussed.

## **Reasons for the Advantages to Outweigh the Disadvantages**

### **The Cultural Perspective**

The literature presented so far, has indicated the various benefits, which are worth the time and care, of teaching children a native language. In this section, the emphasis of the benefits of bringing up a well-rounded bilingual individual (Knafo & Schwartz, 2001; LaFromboise et al., 1993) will be explored. In addition, the strategy of perspective taking may help alleviate the fears of adolescent's becoming embarrassed to speak their native language (Weyant, 2007). Furthermore, the level of



communication may prosper when the parent and child both view the importance of preserving the native language (Hwang et al., 2010).

**The bilingual as a whole person.** LaFromboise et al. (1993) found the multicultural model to be a positive representation of one who is bicultural. This model deems that an individual can uphold an affirmative identity as a participant of his or her ethnic culture of origin, while concurrently cultivating a positive identity by engaging and partaking in activities with other cultural groups. In addition, the pressure to resolve internal struggles caused by bicultural stress does not need to result in undesirable psychological impacts, but could, instead, lead to personal and emotional development. Therefore, one may reason that keeping two languages active makes it easier to achieve this growth.

It is important to note that parents who want their children to learn their native language do not negate the importance of learning English. Knafo & Schwartz (2001) found that many immigrant parents want their children to succeed; this includes their encouragement for children to master a host language, and be familiar with the host culture. This could be done simultaneously with speaking the native language at home. Moreover, LaFromboise et al. (1993) suggested that, to successfully meet the demands of the majority culture, one should have the ability to communicate in both cultures. This underscores the significance of keeping the native language alongside learning English.

**Perspective-taking.** Furthermore, Weyant (2007) tested a hypothesis of whether a technique called perspective-taking would help reduce the negative stigma associated with perceiving people who speak English with an accent. He found when participants took the speaker's perspective, when listening to an audio tape, he or she rated the speaker more favourably even when an accent was present. In the absence of this technique, many rated the speaker as less intelligent than that of the native English speaker. Since Canada is a multicultural society, people are exposed to different cultural groups on a daily basis; some may appreciate this technique to fully acknowledge the diversity of our country. When adolescents are taught to take on the perspective of others, prejudice and discrimination, are likely to decrease.

**The united family.** In 2010, Hwang and colleagues found that programs that target the improvement of parent-child communication barriers may help decrease family struggle. When adolescents take the initiative to learn more about their ethnic culture, family conflict was likely to decrease. Moreover, when a spouse in an interracial marriage teaches children Chinese, it provides a greater opportunity for the other spouse to learn a new language. As Rodriguez-Fornells et al. (2006) indicated, language acquisition is possible across the lifespan.

From the lens of the cultural perspective, these benefits derived from teaching children a native language are immense. The literature indicates that the family is more united and young people profit from speaking the native language, as well as learning English.

## **The Cognitive Perspective**

The cognitive benefits also outweigh its drawbacks. When children learn two languages, simultaneously at a young age, their brains become more flexible (Adesope et al, 2010). The benefits are well-established, even for those students from a lower SES (Kempert et al., 2010).

**The critical period.** Adesope et al. (2010) indicated bilinguals who learn a second language, at an earlier age, have greater metacognitive and metalinguistic traits than those who learn it at a later age. In addition, bilinguals fared better than monolinguals in both domains. This points to the significance of immersing children in a native language, from a young age. Children are more prone to learn the language because they feel that it is natural to speak it. When they get older, they may be more self-conscious about speaking a new language.

**Cognitive rewards.** In several studies (Hakuta & Garcia, 1989; Kempert et al., 2011), the authors discussed the drawbacks of being bilingual, however, in these same studies, the conclusion communicated that the benefits outweighed the costs of teaching children a native language. For example, in Kempert and colleagues' study, the summary section communicated that the, "cognitive advantages of speaking two languages may compensate for some of the disadvantages that occur with lower skills in instructional language as well as with low SES" (p. 551). In other words, with the advantages indicated in the above section, it is worth the time to teach children a native language, since it also benefits this group regardless of the family's SES. In addition, the results indicated that children who speak two languages, and who are immigrants should be considered a resource rather than an encumbrance. This is due to the many cognitive benefits that bilinguals encompass, as indicated earlier. Furthermore, Hakuta and Garcia's literature review concluded that two languages do not contend for mental resources with one another; on the contrary, there are numerous cognitive rewards for bilingualism.

The research shows that language acquisition at a young age removes the barriers associated with learning it later in life. Even when people are in different SES categories, the benefits of knowing two languages is present. Contrary to the belief in previous years, the brain does not compete for resources when speaking two languages. It is apparent, that the cognitive advantages outweigh some of the struggles of learning two languages.

## **Conclusion**

As is presented in this literature review, there are numerous benefits in teaching and immersing children in a native language. Within the cultural perspective, this includes confronting the challenges in different rates of acculturation experienced by the parent and the child. It helps foster a bicultural identity in that both the Asian and Western cultures become important to one's development. The feeling of connection becomes more ingrained when parents and children share a common language that celebrates their tradition. It also works to close the generational gap. From a cognitive perspective, the brains of bilinguals are offered more choice in ways to communicate. Bilinguals, who are proficient in both languages, have shown to fare better in mathematics. They also perform better in executive control tasks compared

to monolinguals. With the added benefit of slowing down the onset of dementia, these cognitive advantages may be well desired.

On the other side, the drawbacks are also supported by research. The parent and the child may have different views in what each party values, thus disagreements may ensue. The young person may feel uncomfortable and awkward when speaking the native language in public. In interracial relationships, one partner may not pursue this teaching with the child, due to not wanting to leave out the spouse. In relation to the cognitive framework, students who are less proficient in one language, such as the language of instruction, may fall behind in performing lexical tasks. When the two languages are quite different in syllabic and phonemic structure, students may experience a more difficult time when learning to spell in English. In situations where the individual is only required to speak one language, it may inhibit the fluency of conversations.

Above all, however, the advantages compensate for the disadvantages. An individual may feel more whole when he or she is able to communicate and connect with both cultures. When individuals learn to be less self-conscious about how society, at large, views their spoken language, there is more room for growth. The family would bond more intricately when the parent and child are able to share more than one language. In the cognitive realm, the child would think it is natural to speak the native language when exposed to it at a young age. In essence, the cognitive rewards are paramount and outweigh the drawbacks in many respects.

One limitation of this literature review is that not all studies are specific to Asian immigrants. In addition to studies specific to Asian families (AhnAllen & Suyemoto, 2011; Boutakidis et al., 2011; Costigan & Dokis, 2006; Hynie et al., 2006; Kim & Omizo, 2006; Mok, 1999; Wu & Chao, 2011, Yeong & Rickard Liow, 2011), in several sections, bilinguals who speak Spanish-English (Gollan & Ferreira, 2009; Rodriguez-Fornells et al., 2006), German-Turkish (Kempert et al., 2011), and Hebrew-Russian (Knafo & Schwartz, 2001), were included. The reason for including these studies pertains to the fact that the bilingual experience and bilingual brain may have similarities. On the other hand, there are also differences such as the language structure of Chinese and English are completely different from one another. Therefore, one may not completely take this review and generalize it to the Asian experience.

In several studies (AhnAllen & Suyemoto, 2011; Gollan & Ferreira, 2009; Hwang et al., 2010; Hynie et al., 2006; Kempert et al., 2011; Yeong & Rickard Liow, 2011; Wu & Chao, 2006), the sample size may not be sufficient to make the findings generalizable. For instance, in Wu and Chao's project, there was a relatively smaller sample size of the Chinese American youths, particularly the first generation group. In addition, this was a questionnaire based on the adolescents' reports and negated to ask the parents for their perspective. In the future, both sides should be attained to gain a better picture of the parent-child relationship. Moreover, further longitudinal studies may benefit in addressing age-related variations.

Future studies need to address some strategies for parents who want to teach, and help their children retain, their native language. In addition, gender differences need to be acknowledged, since there is an assumption that females acquire language at faster rate than males. The learning of differences between genders would help parents

foster a positive learning experience for both girls and boys. Furthermore, there lacks research on whether bilingualism benefits children with special needs. One may come to question whether adding another language would support or hinder children's development if they already have learning challenges. In light of these limitations and future directions, this literature review explored and presented numerous advantages of teaching and immersing children in a native language.

## References

- Adesope, O. O., Lavin, T., Thompson, T., & Ungerleider, C. (2010). A systematic review and meta-analysis of the cognitive correlates of bilingualism. *Review of Educational Research, 80*(2), 207–245. doi:10.3102/0034654310368803
- AhnAllen, J. M., & Suyemoto, K. L. (2011). Influence of interracial dating on racial and/or ethnic identities of Asian American women and white European American men. *Asian American Journal of Psychology, 2*(1), 61-75. doi:10.1037/a0023325
- Anonymous, 2002. David E. Meyer: Award for distinguished scientific contributions. (2002). *American Psychologist, 57*(11), 831-834. doi:10.1037/0003-066X.57.11.831
- Arthur, N., Merali, N., Djuraskovic, I. (2010). Facilitating the journey between cultures: Counselling immigrants and refugees. In N. Arthur & S. Collins (Eds.), *Culture-infused counselling* (2nd ed., pp. 285-314). Calgary, Canada: Counselling Concepts.
- Berry, J. W. (2005). Acculturation: Living successfully in two cultures. *International Journal of Intercultural Relations, 29*, 697-712. doi:10.1016/j.ijintrel.2005.07.013
- Bialystok, E., Craik, F., & Luk, G. (2008). Cognitive control and lexical access in younger and older bilinguals. *Journal of Experimental Psychology: Learning, Memory, and Cognition, 34*(4), 859-873. doi:10.1037/0278-7393.34.4.859
- Boutakidis, I. P., Chao, R. K., & Rodríguez, J. L. (2011). The role of adolescents' native language fluency on quality of communication and respect for parents in Chinese and Korean immigrant families. *Asian American Journal of Psychology, 2*(2), 128-139. doi:10.1037/a0023606
- Costigan, C. L., & Dokis, D. P. (2006). Relations between parent–child acculturation differences and adjustment within immigrant Chinese families. *Child Development, 77*(5), 1252–1267. doi: 10.1111/j.1467-8624.2006.00932.x
- Derakshan, N., & Eysenck, M. W. (2009). Anxiety, processing efficiency, and cognitive performance: New developments from attentional control theory. *European Psychologist, 14*(2), 168-176. doi:10.1027/1016-9040.14.2.168
- Gollan, T. H., & Ferreira, V. S. (2009). Should I stay or should I switch? A cost–benefit analysis of voluntary language switching in young and aging bilinguals. *Journal of Experimental Psychology: Learning, Memory, and Cognition, 35*(3), 640-665. doi:10.1037/a0014981
- Hakuta, K., & Garcia, E. E. (1989). Bilingualism and education. *American Psychologist, 44*(2), 374-379. doi:10.1037/0003-066X.44.2.374



- Hughes, C., & Ensor, R. (2007). Executive function and theory of mind: Predictive relations from ages 2 to 4. *Developmental Psychology*, 43(6), 1447-1459. doi:10.1037/0012-1649.43.6.1447
- Hwang, W., Wood, J. J., & Fujimoto, K. (2010). Acculturative family distancing (AFD) and depression in Chinese American families. *Journal of Consulting and Clinical Psychology*, 78(5), 655-667. doi:10.1037/a0020542
- Hynie, M., Lalonde, R. N., & Lee, N. S. (2006). Parent-child value transmission among Chinese immigrants to North America: The case of traditional mate preferences. *Cultural Diversity and Ethnic Minority Psychology*, 12(2), 230-244. doi:10.1037/1099-9809.12.2.230
- Kempert, S., Saalbach, H., & Hardy, I. (2011). Cognitive benefits and costs of bilingualism in elementary school students: The case of mathematical word problems. *Journal of Educational Psychology*, 103(3), 547-561. doi:10.1037/a0023619
- Kim, B. K., & Omizo, M. M. (2006). Behavioral acculturation and enculturation and psychological functioning among Asian American college students. *Cultural Diversity and Ethnic Minority Psychology*, 12(2), 245-258. doi:10.1037/1099-9809.12.2.245
- Knafo, A., & Schwartz, S. H. (2001). Value socialization in families of Israeli-born and Soviet-born adolescents in Israel. *Journal of Cross-Cultural Psychology*, 32(2), 213 – 228. doi:10.1177/0022022101032002008
- LaFromboise, T., Coleman, H. L., & Gerton, J. (1993). Psychological impact of biculturalism: Evidence and theory. *Psychological Bulletin*, 114(3), 395–412. doi:10.1037/0033-2909.114.3.395
- Mechelli, A., Crinion, J. T., Noppeney, U., O'Doherty, J., Ashburner, J., Frackowiak, R. S., et al. (2004, October 14). Structural plasticity in the bilingual brain [Abstract]. *Nature*, 431, 757. doi:10.1038/431757a
- Miller, E. K., & Cohen, J. D. (2001). An integrative theory of prefrontal cortex function. *Annual Review of Neuroscience*, 24(1), 167–202. Retrieved from EBSCOhost.
- Mok, T. A. (1999). Asian American dating: Important factors in partner choice. *Cultural Diversity and Ethnic Minority Psychology*, 5(2), 103-117. doi:10.1037/1099-9809.5.2.103
- Pessoa, L. (2009). How do emotion and motivation direct executive control? *Trends in Cognitive Sciences*, 13(4), 160–166. Retrieved from, <http://www.sciencedirect.com.aupac.lib.athabascau.ca/science/journal/13646613/13/4>
- Rodriguez-Fornells, A. A., De Diego Balaguer, R. R., & Münte, T. F. (2006). Executive Control in Bilingual Language Processing. *Language Learning*, 56, 133-190. doi:10.1111/j.1467-9922.2006.00359.x
- Weyant, J. M. (2007). Perspective taking as a means of reducing negative stereotyping of individuals who speak English as a second language. *Journal of Applied Social Psychology*, 37, 703–716. doi: 10.1111/j.1559-1816.2007.00181.x
- Wu, C., & Chao, R. K. (2011). Intergenerational cultural dissonance in parent-adolescent relationships among Chinese and European Americans. *Developmental Psychology*, 47(2), 493-508. doi:10.1037/a0021063
- Yeong, S. M., & Rickard Liow, S. J. (2011). Cognitive-linguistic foundations of early spelling development in bilinguals. *Journal of Educational Psychology*, 103(2), 470-488. doi:10.1037/a0022437

*Competition Anxiety in Egyptians Children Sportsmen*

Amr Hassan, Ahmed Ali

Mansoura University, Egypt

0483

The Asian Conference on Psychology & the Behavioral Sciences 2013

Official Conference Proceedings 2013

Abstract

Studying the anxiety of the children sportsmen has increased in the past ten years. A lot of studies aimed to identify the causes of anxiety and how to get minimize it. Our hypothesis is the children athletes suffer anxiety resulting from the training and participation in competitions in addition to natural anxiety factors apart from sport. If this hypothesis is correct, we would expect an increase in intensity of anxiety for children during the competitions in the three types of sports. The aim of this study was to identify the difference of competition anxiety in children during their participation in sports competitions. Study summaries with football players (n = 21), Handball players (n = 21), and judo players (n = 21) and results indicates to the existence of significant differences between football, handball and judo children players in scale anxiety.

Key words: state anxiety, child, sports



## 1. Introduction

Each year, Egyptian children participate in competitive sport activities. Competition has become so important in today's society that extremely lofty expectations are placed on competing athletes regardless of competitors' abilities, reasons for participation, and skill levels. These conditions place high stress loads on the individuals who are competing. This results in anxiety, feelings of nervousness and tension caused by the environment or surrounding expectation those are related to 'arousal', result. There is often imbalance between the demands and the athlete's ability to fulfill the expectation. (Behroz Khodayari, Abdulmir Saiiari, Yaghob Dehghani 2011)

For many sportsmen, sports activities can be filled with anxiety and fear manifested in many ways including fear of failure, fear of societal consequences, and worry about not living up to the expectations of adults (Gould, & Weinberg, 1995; Lewthwaite & Scanlan, 1989; Scanlan & Lewthwaite, 1984; Scanlan & Passer, 1978).

Stadulis, R. E., Mac Cracken, M. J., Eidson, T. A. & Severance, C. (2002) presented a conceptual list of sport performance anxiety. This list was designed to support the theory of competitive anxiety being multidimensional (physical anxiety - anxiety cognitive - self-confidence). Spielberger (1966) expressed that anxiety can take two forms: state anxiety or trait anxiety, state anxiety refers to a temporary emotional state consisting of fear or apprehension, where a trait anxiety refers to a predisposition to perceive situations as potentially threatening and respond with manifestations of state anxiety.

State anxiety is "characterized by subjective, consciously perceived feelings of apprehension and tension, accompanied by or associated with activation or arousal of the autonomic nervous system" while trait anxiety is an "acquired behavioral disposition that predisposes an individual to perceive a wide range of objectively non dangerous circumstances as threatening and to respond to these with state anxiety reactions disproportionate in intensity to the magnitude of the objective danger".

Athletes who are predisposed to higher Levels of trait anxiety will perceive sport competition environments as being more threatening than they may actually be, and will respond with greater state anxiety responses. Anxiety in sport can be manifested in many ways. Morris, Davis, Hutchings (1981); Sarason (1984) indicated the existence of two distinct dimensions of anxiety; cognitive anxiety and somatic anxiety. Cognitive anxiety is predominantly psychological in nature and is characterized by feelings of worry about outcomes and the use of negative mental imagery.

Conversely, somatic anxiety is physiological in nature and includes increases in heart rate and increased perspiration. An excellent review of the relationship among forms of anxiety has recently been published (Smith, Smoll, & Wiechman, 1998). The manifestations of anxiety have been shown to have numerous negative effects on performance. For example, Yoo (1996) indicated that anxiety is an influential variable in reducing cue-utilization and attention processes of motor task performance. These findings are supported by Lee, Kim, Yang, Chung (1992), Graham-Jones and Cale

(1989) who also found that forms of anxiety reduced elements of motor performance (i.e., reaction time and percept-motor speed respectively).

Anxiety in athletes may also affect the relationships between athlete and coach. Knowe and Williams (1992) indicated that anxiety in athletes influences their evaluation of coaching behaviors. Athletes who were more anxious and less confident were found to evaluate coaching behaviors more negatively. Purpose of this study was identifying of state anxiety which contain self-confidence, cognitive anxiety, and somatic physical anxiety in team handball, team soccer, and judo.

## 2. Methods

Three groups team handball, soccer, judo each one 21 male subjects (mean age 12; max-min =11-13 years) volunteered for the study with the informed consent of their parents. All were regional team handball, soccer, judo players from 3 clubs belonging to the same geographic area. They participated in local competitions. Their mean competitive experience was  $3 \pm 1.3$  years. This study was performed during the competitive season (from September to May). During this period, all the subjects participated in local competitions. The subjects were tested on cognitive anxiety, confidence, and somatic physical anxiety. The study was conducted according to the declaration of Helsinki and was approved by the local Ethics Committee.

## 3. Measurements

A children's form of the competitive state anxiety inventory (CSAI-2C) (Stadulis 2002) was used to measure state anxiety. All players from the groups were carefully familiarized with the test protocol of the anxiety scale which contains 5 sentences for each measurement of cognitive anxiety, somatic physical anxiety, and self-confidence, with each arranged on a scale quartet to measure attributes from lesser degree to the highest degree. It was given to all the players before the start of the first league championship game, and all items were explained.

## 4. Results

Table1: Mean (Std. Deviation) of State Anxiety Scale (n=21)

Type of sport	Non Self-confidence		Cognitive anxiety		Somatic physical anxiety		Total	
	Mean	Std. Deviation	Mean	Std. Deviation	Mean	Std. Deviation	Mean	Std. Deviation
Handball	13.5	1,6	9.2	3.7	12.1	2.7	34.9	4,9
Judo	8.7	1.5	15.6	2.1	16.3	1.4	40.8	2.8
Soccer	17.2	2.2	6	1.5	7.8	2	31.4	2.8

Table (2) Values of anxiety state scale with the players P values also shown.

ANOVA				
	Sum of Squares	Df	F	P
<b>Self-confidence</b>				
Between Groups	766.381	2	118.921	.000
Within Groups	193.333	60		
Total	959.714	62		
<b>Cognitive anxiety</b>				
Between Groups	958.127	2	70.026	.000
Within Groups	410.476	60		
Total	1368.603	62		
<b>Somatic physical anxiety</b>				
Between Groups	762.952	2	82.701	.000
Within Groups	276.762	60		
Total	1039.714	62		
<b>Total scale</b>				
Between Groups	934.508	2	34.409	.000
Within Groups	814.762	60		
Total	1749.270	62		

\*. The mean difference is significant at the 0.05 level.

Table3. Mean (Std. Error) of State Anxiety Scale and Team handball, Soccer, Judo

LSD

	Var (1)	Var(2)	Mean Difference (I- J)	Std. Error	P.
Self- confidence	Handball	Judo	4.761*	.55397	.000
		soccer	-3.761*		
	Judo	Handball	-4.7619*		
		Soccer	-8.523*		
	Soccer	Handball	3.7619*		
		Judo	8.523*		
Cognitive anxiety	Handball	Judo	-6.428*	.80719	.000
		soccer	2.904*		
	Judo	Handball	6.428*		
		Soccer	9.333*		
	Soccer	Handball	-2.9047*		
		Judo	-9.333*		
Somatic physical anxiety	Handball	Judo	-4.190*	.66280	.000
		soccer	4.333*		
	Judo	Handball	4.190*		
		Soccer	8.523*		
	Soccer	Handball	-4.333*		
		Judo	-8.523*		
Total scale anxiety	Handball	Judo	-5.857*	1.1372	.000
		soccer	3.476*		
	Judo	Handball	5.857*		
		Soccer	9.333*		
	Soccer	Handball	-3.476*		
		Judo	-9.333*		

for comparisons  $P < .05$

## 5. Discussion and Conclusions

Table (1),(2),(3) indicates to the existence of significant differences between soccer, handball, judo in state anxiety scale in general and in parts, self-confidence and anxiety physical and anxiety cognitive where the value of  $p > .05$ .

Researchers indicates that the difference between players in scale anxiety because the different nature of performance. Players were got high average non self-confidence, low average anxiety cognitive and somatic physical anxiety within each game number of soccer players large and space play a large and dynamic performance was slow somewhat divided by the number of players and find each player support from his colleagues during the performance whenever he need it.

This is leading to reduce the size of psychological burden actually on the squad also does not require the player to participate directly in each attack, thus easing the pressure it on the other side. while we find that performance in handball more speed and increase the responsibilities of each player directly and increases scoring any error or weakness in the performance of any player lead to the possibility of scoring a direct.

Players of handball fall under the pressure of physical performance rapid and commitment rules of the game is difficult and space pitch small, raising the proportion of concern physical, cognitive, at least with the proportion of self-confidence because Each player is directly responsible for the position in addition to his support for his colleagues in the fastest time and the best performance.

As in judo seems the results is clear, less than self-confidence to less degree and brings with it anxiety cognitive and physical to the highest degree due to, the player in judo official alone all success or failure and there is no any kind of assistance.

They are in individual game Pressure psych on player in addition to that achievement depends on the capabilities of the physical and cognitive player game they need for fitness in the first place, skill and consequently increases physical and cognitive anxiety players.

The researchers have suggested there is a fundamental difference in performance and its relationship to anxiety for participants who play team sports versus individual sports, (Martens et al., 1990b; Terry, Cox, Lane, & Karageorghis, 1996, Lynette L,Craft,(2003). The number of individuals participating together may moderate the effect of anxiety on performance. Specifically, some argue that participants in individual sports should be more adversely affected by anxiety than those in team sports (Martens et al., 1990b; Terry et al., 1996).

Performance in which athletes work with others to try to obtain optimum sport performance may have a different relationship with anxiety than does performance undertaken by oneself. Researchers examining the relationships of other pre competitive mood states (e.g., depression, anger, tension, and fatigue) with performance have found that the variable of team or individual sport moderates the relationship (Beedie, Terry, & Lane, 2000).This results according with David, Masayuki,Takeshi , Eio (2012) that the more anxiety predicted less confidence.

In conclusion, the psychological preparation of junior handball, soccer and judo players must be taken into serious consideration, during the coaching procedure. Nonetheless, further investigation is needed for the generalization of the results in handball, soccer and judo.

## 6. Reference

- Aker, J, & Hawes, R, 2000, 'The relationship between coaching behaviors and sport anxiety in athletes', *Journal of Science and Medicine in Sport*, 3 (2): 110-119.
- Beedie, C, J, Terry, P, C, & Lane, A.M, 2000, 'The Profile of Mood States and athletic performance: Two meta-analyses', *Journal of Applied Sport Psychology*, vol, 12, 49-68.
- Behroz Khodayari, Abdulamir Saiiari, Yaghob Dehghani, 2011, 'Comparison Relation between Mental Skills with Sport Anxiety in Sprint and Endurance Runners', WCPCG 2011, *World Conference on Psychology, Counseling and Guidance Cesars Temple Hotel*, 25-29 MAY, 2011, Antalya, Turkey.
- David Matsumoto, Masayuki Takeuchi, Takeshi Nakajima and Eio Iida, 2012, 'Competition anxiety , self-confidence , personality and competition performance of American elite and non elite athletes', *The sports journal, America's sports university* , United States sports Academy, Volume 15, 2012, ISSN: 1543-9518.
- Gould, D. & Weinberg, R, 1995, '*Foundation of Sport and Exercises Psychology*', Human Kinetics (chapter 17)
- Graham-Jones, J, & Cale, A, 1989, 'Relationships between multidimensional competitive state anxiety and cognitive and motor subcomponents of performance', *Journal of Sports Sciences* 7(3): 229-240.
- Kenow, L, J, & Williams, J, Mi, 1992, 'Relationship between anxiety, self-confidence, and evaluation of coaching behaviors', *The Sport Psychologist* 6 (4): 344-357.
- Lee, IC H, Kin, S, J, Yang, M, H, & Chung, C, H, 1992, ' Effects of preliminary muscular tension on reaction time and movement accuracy', *Korean Journal of Sport Science* vol, 4, 59-69.
- Lewthwaite, R., & Scanlan, T, K, 1989, 'Predictors of competitive trait anxiety in male youth sport participants', *Medicine and Science in Sport and Exercise*, 21(2): 221-229.
- Lynette L, Craft, T, Michelle Magyar, Betsy J, Becker, and Deborah L, Feltz, 2003, 'The relationship between competitive state anxiety inventory and sport Performance: A Meta-Analysis', *Journal of sports & exercise psychology*, 25, 44-65.
- Martens, R, Burton, D, Vealey, R. S, Bump, L, A, & Smith, D, E, 1990, 'Development and validation of the competitive state anxiety inventory-2 (CSAI-2), In R. Martens, R, S, Vealey, & D, Burton (Eds.) ', *Competitive anxiety in sport*, pp. 117- 213, Champaign, IL: Human Kinetics.
- Morris, L W, Davis, D, & Hutchings, C, 1981, 'Cognitive and emotional components of anxiety: Literature review and revised worry-emotionality scale', *Journal of Educational Psychology*, vol 73(4), Aug 1981, 541-555
- Sarason, I, G, 1984, 'Stress anxiety, and cognitive interference: Reactions to tests', *Journal of Personality and Social Psychology* 46: 929-938.



- Scanlan, T, K, & Lewthwaite, R, 1984, 'Social psychological aspects of competition for male sport participant's predictors of competitive stress', *Journal of Sport Psychology*, 6: 208-226
- Scanlan, T, K, & Passer, M, W, 1978, 'Factors related to competitive stress among male youth sport participants', *Medicine and Science in Sports*, 10: 103-108.
- Smith, R, E, Smoll, F, L, & Weichinan, S, A, 1998, 'Measurement of trait anxiety in sport, In J, L Duda ( Ed ) ', *Advances in Sport and Exercise Psychology Measurement*, pp.105-128.
- Stadulis, R. E, Maccracken, M, J, Edison, T, A, & Severance, C, A, (2002), 'Children's form of the Competitive State Anxiety Inventory: The CSAI-2C', *Measurement in Physical Education and Exercise Science*, 6(3), 147-165.
- Terry, P, C, Cox, J, A, Lane, A, M, & Karageorghis, C, I, 1996, 'Measures of anxiety among tennis players in singles and doubles matches', *Perceptual and Motor Skills*, 83, 595-603.
- Yoo, J, 1996, 'Multidimensional anxiety responses and cue-utilization processing in a dual motor task situation', *International Journal of Sport Psychology* 27(4): 425-438.

The logo for 'iafor' is centered on the page. It consists of the lowercase letters 'iafor' in a light blue, sans-serif font. The logo is partially enclosed by a large, light blue circular arc that starts from the bottom left and curves around the right side. A smaller, light red circular arc is positioned above the 'iafor' text, partially overlapping the blue arc.

*The Diagnostic Technique of Activity, Action and Deed Reflection*

Maria Kuznetsova

National Research University of Higher School of Economics, Russia

0448

The Asian Conference on Psychology & the Behavioral Sciences 2013

Official Conference Proceedings 2013



iafor

iafor  
The International Academic Forum  
[www.iafor.org](http://www.iafor.org)

## **Definition of reflection as a subject of psychological diagnostics**

The problem of defining the category of reflection (from Late Latin *reflexio* - rear-facing) has been an issue with psychologists ever since its inception. This term was borrowed from Philosophy. Its first occurrence dates back to the study of the problems of human consciousness in the Philosophy of Modern Times. This refers to the phenomenon of internal circulation of consciousness onto itself. Later on, the term came to refer to reflection - the study by the subject their own cognitive act. Different systems of Philosophy hold the term *reflection* in their own way and it has always had different content (essence) for different philosophers. "Locke believed it to be the source of unique knowledge when observation is aimed at the internal action of consciousness, while the feeling (sensation) is outwardly-oriented. For Leibniz reflection is nothing but attention to what is going on inside us. According to Jung, ideas -are a reflection of the impressions received from outside. "

In Psychology, over the period of its existence, there also developed several different approaches to the understanding of the reflection processes, the role of reflection in the mental life of man. One of the first substantive definitions of reflection in Psychology was given by W. James. He regarded reflection as an appeal of the knowing "I" to the knowable "I" within structure of consciousness: "My identity is sort of dual - partly knowable and partly knowing, being the object and the subject at the same time, it is necessary to distinguish the two sides in it "[James, 1991, p. 87]. A. Busemann proposed allocating a separate area of psychology: a Psychology of introspection which should study reflexive processes and consciousness. According to Busemann, reflection - is any transfer of emotional experience from the outside world onto oneself. A somewhat different interpretation of the concept of reflection can be found in the works on the problems of mental development of man. Thus, Piaget explored reflection, defining it as a logical process, characterized by the knowledge of the necessary connection between the object and the effect on it, which is then conceptualized into a notion [Piaget, 1969].

Another tradition has developed in Russian psychology. Reflection here acts as an explanatory principle of self-consciousness and psyche in general (S.L. Rubinstein, B.G. Ananiev, Vygotsky, B.V.Zeygarnik etc.). The problem of the concept of reflection, the mechanisms of its manifestations, development, its impact on the formation of consciousness and self-awareness, on the cognitive functions, and processes of activity are raised by many Russian researchers. At the same time the importance of the problem of reflection in Russian psychology leads to the formation of multiple approaches to its interpretation.

In this paper, we aim to outline some of the most significant moments in the context of dealing with our main problem: defining reflection as a subject matter of psychodiagnostics. While acknowledging certain differences in understanding of the general reflection, we can't fail to notice that it characterizes the overall orientation of the subject onto the inner world in its various qualities and dimensions. These can be emotional states and experiences, manifestations of conscience and consciousness deeds. Reflection, aimed at the cognitive activity, is understood as the ability to recognize one's own thinking process, as well as the ability to recognize and restructure one's underlying bases or certain initial notions. It is through reflection

that conscious development of new algorithms for solving problems and patterns of behavior takes place.

It is important to note that the processes of reflection are going on gradually, in parallel with the development of thinking. The transition of any component of activity into the focus of consciousness is when we get hold of new and complex action or when we deliberately analyze the components, which are associated with any uncertainties and errors. "The property" of each component skill to once again become conscious is very important because it provides the flexibility of skill, the possibility of its further improvement or alteration." Realization by man of his or her own actions and mobilization of their personal resources are required, whenever available automaticity does not provide resolution of existing difficulties and obtaining the necessary results. The need for improvement or supplementation is thus accentuated.

That line of reasoning elucidates both the importance of reflection in the processes of consciousness and human psyche development, and the unbreakable bond of reflection with the activities under which influence it is manifested. Reflection is revealed in individual actions, activities and deeds and determines their efficiency in the procedural aspect and ultimate effectiveness. Hence, we believe it is necessary to put forward the question of studying and diagnosing reflection not in isolation, but within the context of certain actions.

Summarizing the analysis of different approaches in this work, we can define reflection as a process of self-knowledge (the process of thinking aimed at the subject, in the totality of its qualities and manifestations: the needs, motives, emotional states, feelings, phenomena of conscience, knowledge, personality traits, actions, activity, behavior, etc.).

Reflexivity, in its turn, will act as a quality of personality which characterizes its tendency to explore itself. Reflexivity will contribute to the successful implementation of any activity, through directing the process of thinking, organizing and managing it. Personality, through its quality of reflexivity, will manage the task of solving a problem as well as that of channeling its thoughts.

Henceforth, the terms reflection and reflexivity can be used interchangeably, with the difference that by reflection, we understand the process, and by reflexivity - personal quality that determines the level of reflection.

### **The existing diagnostic methods of reflection and reflexivity**

In scientific literature, there are a significant number of diagnostic methods for treating reflexive processes. However, all of the existing approaches focus on the local assessment of reflection, regardless of the types of activities in which it appears. Some of the existing methods aim to diagnose certain types and forms of reflection, in line with its objective reference, others - to diagnose the overall level of reflexivity, considered as a unified system property.

It is the aforementioned lack of unified view on the problem of the nature of reflexive processes that gives rise to complications while diagnosing reflection.

The main problem here lies in the discrepancy between the basic views on the possibility of differentiating reflection within those subject areas for which it unfolds. In particular, D. Dubrovsky and S. Rodriguez, while considering reflection a "holistic" phenomenon, reject the very idea of typology of its forms and manifestations. A.V. Karpov, I.M. Skityaeva, V.V. Ponomarev and some others hold similar positions. These authors suggest methods of reflexivity diagnostics as a complex but unified and holistic notion.

However, most of the authors (I.N. Semenov, S.J. Stepanov, A.B. Kholmogorov, V.I. Slobodchikov, etc.) offer various classifications of reflexive processes, differing in the criteria for selection of their types. The most detailed classification of reflexive processes and phenomena that takes into account most of the major approaches to their study, is proposed in the works of I.N. Semenov and S.Y. Stepanov. Trying to overcome the restriction on adoption of the term "reflection", the authors summarized the main psychological interpretations of reflection as they are held by A.V. Petrovsky, L.S. Vygotsky, V.V. Davydov, A.M. Matyushina, O.K. Tikhomirov and other Russian psychologists. Accordingly, for each of the types and processes of reflection these authors suggest applying separate diagnostic procedures. There are some more specific methods of diagnosing and analyzing the reflective processes. In particular, they might include the methods of diagnosing the intellectual component of reflection, such as A.Z. Zack's tasks.

With all the variety indicated, the analysis of the existing approaches to the diagnostics of reflection, both in the Western and Russian psychology, suggests that reflection activities are not currently being studied by anybody.

In conclusion, it should be noted that the diagnostic systems for studying reflection in practice often appear to include diagnostic techniques for assessing the ability of a person for self-exploration, research methods of personality constructs where reflection is understood as the capability of a person to understand these constructs, also methodology of determining the locus of control, when reflection is the ability to objectively assess the situation in life, methods for diagnosing creative thinking, that is, the cognitive component of reflection, or the process of thinking, etc. All the outlined techniques are not designed for focused study of reflection and are used for that purpose only because there is no clear-cut definition of the concept of reflection and the limits of its manifestations, as well as proven methods of diagnostics.

### **The model of reflection on action, activity and deed.**

The task of analyzing the mechanisms of reflection manifestation in the activity challenges us with the need to develop our own toolset for research and diagnostics. And, before starting to develop our own diagnostic tools, we need to develop a clear and explicit diagnostic construct or operational model of the subject of diagnostics.

In developing the methodology, we relied on the ideas of the subject-active approach in Russian psychology (S.L. Rubinstein, K.A. Abulkhanova, A.V. Brushlinskii, etc.) and the concept of the systemogenesis (V.D. Shadrikov). There appeared a reflection model of action, activity and deed based on the concept of action systemogenesis. In accordance with the developed model, a set of figures was determined for assessing

productivity of reflection in action. The basic idea was to correlate reflexive processes with the major components of a functional system of psychological activities (hereinafter PFSA) proposed by V.D. Shadrikov. Each of the PFSA components reflects certain stages of subject's activity as well as their specific tasks. PFSA describes activities in an aggregated form and is a universal explanatory model for all forms of activity of the subject.

Reflection is present in the formation of each denoted component of the activity system, allowing us to present the process of formation of each component as well as the overall performance. Thus, reflection provides for the process of systemogenesis activities. Psychological functional activity system is formed within systemogenesis activity [10]. In expanded form it is presented in Fig. 1.

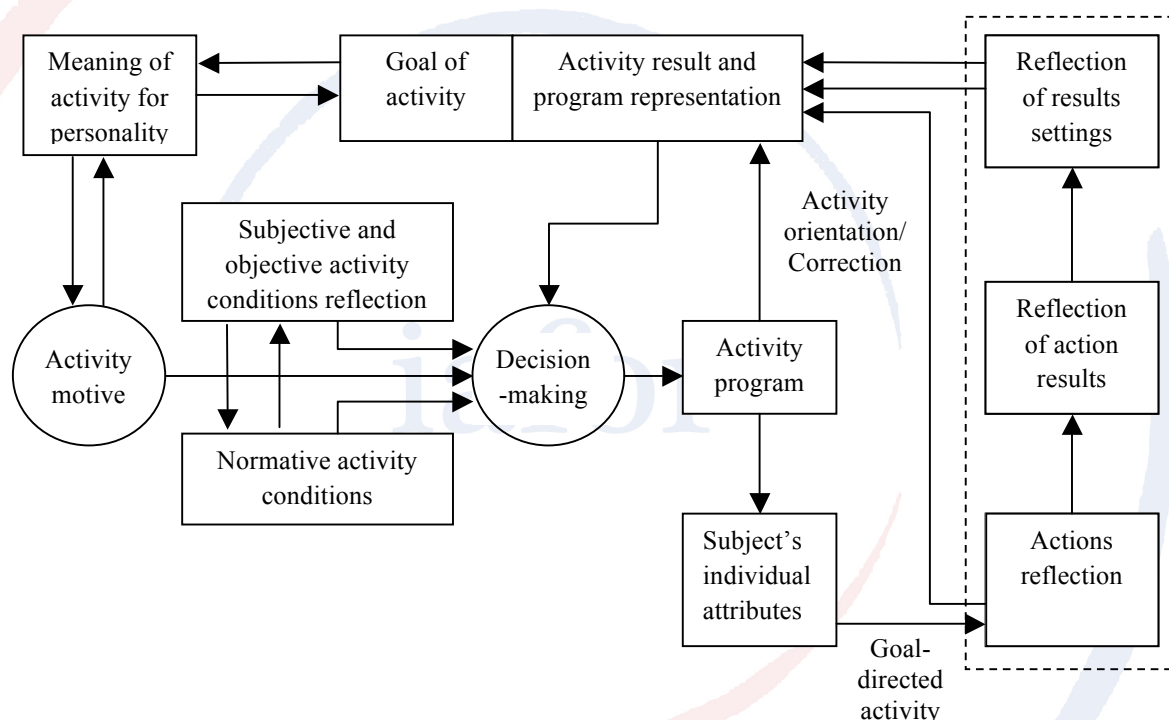

**Figure 1. The general architecture of psychological functional activity system (PFAS)**

Considering the reflection in each of the components of PFAS, we can present a theoretical model of reflection and reflexivity in the activity (Fig. 2).



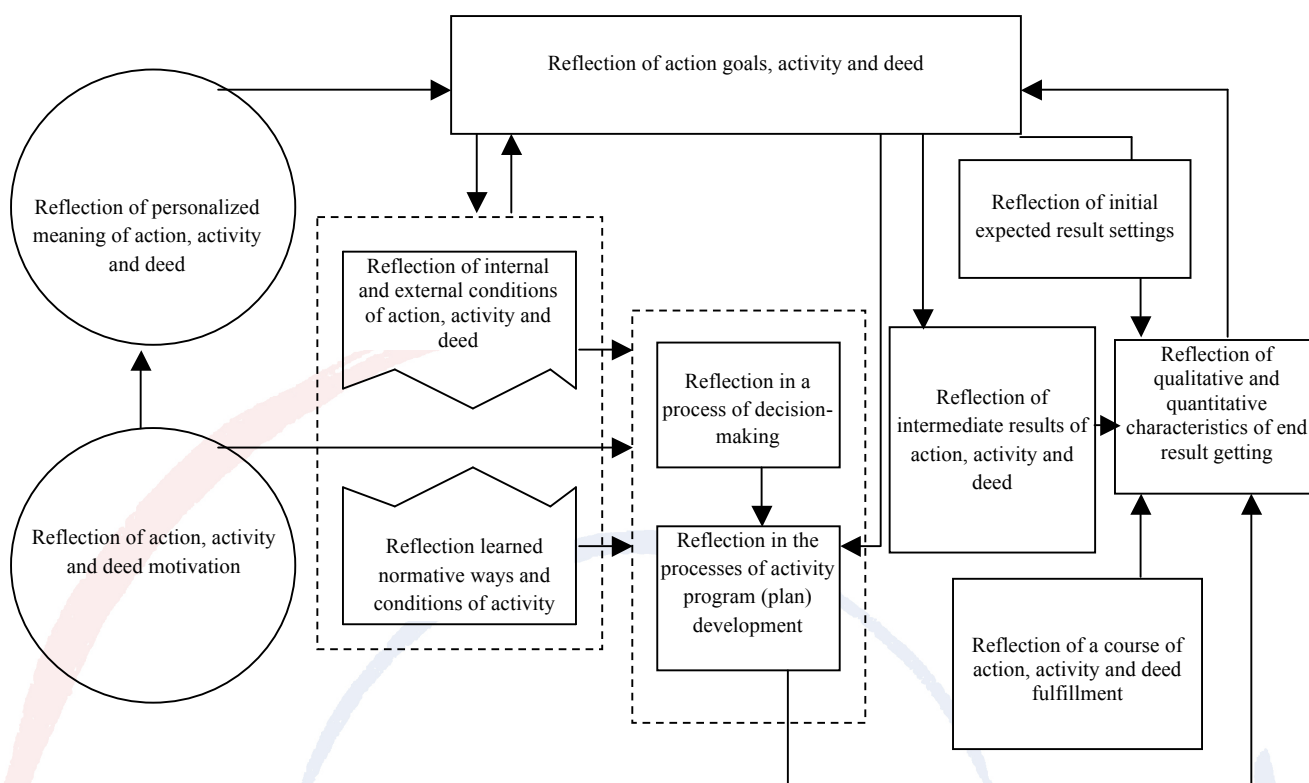

**Figure 2. Theoretical model of activity reflection and reflexivity**

Reflexivity, being essentially a personal quality of a subject, which determines the subject's capacity for reflection, will be manifested in all the components of a functional system of psychological activity. The level of reflexivity will affect the ability of the subject to assess various parameters of their own activities, to harmonize individual components into an integrated system to get the planned desired result. The specifics of the enacted reflexive mechanisms will determine the solution features of certain types of tasks. Analysis of these specific features will highlight the strengths and weaknesses of the subject's activity, and will help to get a qualitative picture of the unfolding mental processes that either encourage or hinder getting the desired result. Accordingly, it will make the necessary adjustments in the activity of the subject, increasing its efficiency.

In the educational process this model will help to consciously approach the task of developing both cognitive abilities and the personality of a student, the task of ensuring comprehension of the offered material, as well as search for effective solution strategies of learning tasks, etc.

The essential point of our work is to address the category of deed. Deed, in addition to an objective assessment of its effectiveness, involves moral evaluation of its contents (personal, spiritual, moral and ethical aspects). Resorting to this category gives an opportunity to consider not only cognitive and procedural, but also the personality aspect of human behavior. Speaking of deed, we take into consideration the moral and ethical basis for the regulation of behavior and activity of the subject. This approach allows us to integrate various components of mental regulation of behavior and human activities into a single system. In the actual process of activity, reflection will

activate all the components of the inner world of the individual – at the stage of identifying objectives, analyzing conditions, decision-making, developing a program, etc. That is why, as we noted above, reflection provides the process of activity systemogenesis as well as gradual awareness on the part of the subject of his or her place throughout activity.

Deed reflection just as reflection of activity (and separate actions) will be manifested in all the components of the functional system of psychological activity. We can talk about the reflection on the deed motives, objectives and personal meanings, the environment in which it takes place (the moral and ethical aspect), moral evaluation of one's own decisions, actions and results. Thus, each component of the activities can be viewed with regard to the level of reflection on the activity (in terms of parameters of its effectiveness), and the level of deed awareness (in the parameters of moral evaluation of one's actions and manifestations of spirituality). In other words, productivity of reflection mechanisms is examined from the angle of activity and action in the context of achieving the desired results. It is within the deed evidence that the features of moral and ethical regulation as well as evaluation of behavior are subjected to scrutiny.

It is important to note that reflection on the activity and that on the deed, within the same components of the activity, can be represented unevenly. A person can simultaneously display high reflection rates on activity (be clearly aware of what they need to get the desired results) and low reflection rates on an act (not thinking whether their actions would be ethical and how they are consistent with their beliefs and what kind of consequences would ensue for others etc.), and vice versa. Within the structure of activity, the claimed specificity is associated with differently targeted reflective processes denoted above. In the first case, the target component is the desired result, in the second - following one's own convictions, principles and moral norms of behavior. In practice, these targets can not only diverge, but also contradict each other.

All the outlined peculiarities tend to assume particular relevance and urgency in the educational process. They should be conceived of as immediate priority analysis for solving problems of intellectual and personal development of a child.

Summing up the aforementioned, we can move on to the operationalization of the proposed theoretical models of reflection and reflexivity in action. This analysis allows us to identify the following production rates of reflection (the level of reflexivity maturity):

- The degree of awareness of basic needs and motives for the action, activity and deed (awareness of what I really want, what motivates me to be active.)
- Description of the goals set for action, activity, and deed (having a clear image of the desired result, the degree of its compliance with the needs and motives).
- Assessment of internal and external conditions of action, activity and deed, normative ways of activity (identifying one's own resources, capabilities and limitations in the context of relevant activity and imposed requirements on it).
- Decision-making in the implementation of the actions, activities and deeds (awareness of assumptions, causes and consequences of the decisions made by the person, grounds for the disposition of alternatives, making a choice among alternatives, the reasons for the imposed restrictions, etc.).

- Elaborating a program (plan) of action, activity, and deed (the availability of a possible sequence of actions to obtain the desired result, the degree of detail in the data submission, analysis of the necessary conditions, resources, time, costs, etc.).
- Implementation of actions, activities, and deed (evaluation of the various implementation options of action and activity, and related constraints, dynamic characteristics and a correlation with the expected results, etc.).
- Evaluation of the interim results of action, activities and deeds (the presence of fixed milestones, performance data logging in qualitative and quantitative aspects, activity adaptation to the desired final result on the basis of intermediate results, etc.).
- The qualitative and quantitative data of the final result (awareness of the qualitative and quantitative characteristics of the desired end result, parameters to correlate the intended and actual result, awareness of the causes of any differences, ways to correct these discrepancies, etc.).

### **Development of methodological toolset**

The work fulfilled, including the definition of the basic concepts, elaboration of a model for the object of diagnostics and selection of indicators for assessment of reflection productivity, let us move on to developing methodological toolset for the study of reflection and reflexivity in action. The technique elaboration was carried out in several stages. This is a description of each:

*1. Elaboration of the test's primary form. This phase included the following procedures:*

- Defining the parameters for the subject of diagnostics.
- Selecting the validity sphere within the developed methodological tools.
- Selecting the responses scale.
- Selecting the task types according to the nature of the answer.
- Designing and wording the questionnaire tasks, in accordance with the developed theoretical construct.
- Determining the structure of the questionnaire and the order of tasks placement in the method.
- the Initial testing of the created form on a pilot sample.

*2. Psychometric validation of the test. This phase included the following procedures:*

- Analysis of test items: to determine how much each of the test questions correlates with the general content of the diagnostic technique.
- Testing the main types of test reliability: to determine how test results are subjected to various extraneous factors.
- Evaluation of the essential types of validity or relevance of the test: determination of how well the created technique fulfills its diagnostic tasks, i.e. diagnoses the construct that underlies it.

*3. Calculation of regulatory indicators (standardization). This phase included:*

- Building empirical series (distribution) and calculation of its parameters.
- Blunder avoidance.
- Comparison of the empirical distribution against the normal theoretical distribution.
- In the absence of direct differences between the empirical distribution and the theoretical normal distribution, designation of the bar graph level is according to

the parameters of the empirical distribution, namely through the method of signal deviations (linear standardization).

– In case of proved differences between the empirical distribution and the theoretical normal distribution, calculation of the characteristics of a normal percentile ranking range and the implementation of the nonlinear normalization procedure are performed.

In the course of testing, expert opinions and reviews of the respondents regarding the wording of individual questions, the type of test forms, user experience with diagnostic tools, etc were also collected. As a result, some questions were excluded from the primary form of the questionnaire, a number of formulations have been amended to ensure a clear understanding of questions by all the respondents.

### **General characteristics of the diagnostic techniques of reflection on action, activity and deed**

The final technique version is in the form of a questionnaire, which consists of two relatively independent units.

The first block is represented by 56 closed questions with suggested answer (each question containing 5 options). This form of technique elucidates a subjective assessment of the respondent obtained as a result of self-observation. It allows you to assess the degree of respondent's awareness of the reflection process at different stages of his or her activity, and to what extent their reflective analysis guides their behavior. The use of closed questions makes this methodology universal, it simplifies the process of filling, processing and interpreting the results. This unit can be regarded as an independent and holistic methodological tool, it is sufficient for diagnostic purposes. The form of the questionnaire allows for measurements in the mode of group work, makes the procedure of diagnosing fairly compact in time and effort on the part of respondents. Processing and interpreting of the results does not require special training. Implementation is conducted in accordance with the attached keys and scales. This approach may be preferable for mass surveys, collecting a large data set (testing of a class, flow, etc.).

The second unit is designed for a more profound analysis of the manifestation mechanisms of reflection and reflexivity in action. It consists of nine open-ended questions. Open-ended questions allow you to check the degree of adequacy of the respondent's self-appraisal. They require of the respondent a detailed answer with a description of the criteria by which he/she is actually guided in evaluating their own actions, activities and behavior. Within the method, this unit at the same time encourages the respondent's development, formation of their skills of reflective analysis. Open-ended questions are not a mandatory part of the procedure and can be used at the request of the researcher, depending on the purpose of assessment procedures. Resorting to the second unit of the questionnaire allows an in-depth, qualitative analysis of the subject's own reflection. It is here that conditions for thinking hard are created, for expressing one's own opinion and judgment. This part can be called the main in the individual work with the subject, should the need to resort to qualitative research methods arise. It should be noted that the open-ended questions also presuppose a more qualified analysis of the responses, which imposes certain requirements on persons engaged in the processing and interpreting of data.

Detailed criteria for evaluating the responses of the subjects to open-ended questions are in the making; it will remove the imposed restrictions and significantly simplify the procedure of data processing.

Using these two questionnaire units allows to rely both on the results of respondents' self-evaluation and self-analysis (their subjective vision), and on the results of the objective assessment of the criteria for the right things, as well as capacity for reflection and formulating one's own thoughts (also at their disposal). This allows the comparison of subjective vision and expertise, permitting to determine the productivity of respondents' reflection, the adequacy of their judgments and perception of themselves.

Questions of both units are structured according to the sequentially solved problems of activity and to the major components of the psychological functional system of activity. Such logic of putting forward issues reflects the typical stages of activity and matches the succession of the solved problems. This allows respondents to carry out a reflective assessment of their own actions and behavior in the same time perspective in which they typically unfold.

Processing of the results is handled in accordance with the key provided. Estimates of the level of reflection on action, activity and deed are calculated separately. Within the structure of both indices, estimates for each PFSA component (activity stage that reflects the type of problem solving) as well as the general final grades are calculated. Procedure for the technique does not involve any time constraints. On average, work with each technique unit takes 15 - 20 minutes.

The method is designed to work with respondents aged 16 and older. For different age groups there should be different regulatory scales for converting test scores into standardized assessments. At the moment, these scales are being developed. Throughout the testing, we were led to believe that the results are practically irrespective of the subjects' sex. This makes the technique equally applicable to both female and male subjects sample.

### **Testing and psychometric verification techniques**

The first testing procedure took place in October - November 2012. The sample included students of various departments of RU HES from first to fourth year undergraduates (aged 17 to 24 years). Total number of the tested participants amounted to 80 students. The testing consisted of two main stages:

- The primary survey (test)
- The secondary survey (retest)

The sample in the first and second stages remained identical, which allowed to check up retesting reliability of the developed instruments.

At the first stage in the validation procedure, questionnaire forms to the first and second units of the technique were distributed among the participants, the time of work was not limited by the method. In addition to the common instructions, participants were asked to mark validation issues that caused them difficulty in understanding or in wording the answers. In the end respondents were asked to write



comments about the features of the methodology, usability of questionnaire forms, the overall comprehensibility of the issues, clarity of the proposed structure, advantages and shortcomings of the techniques. According to the results of testing, feedback from the participants was thoroughly studied and, as a result, a number of issues have been amended.

In the second phase of testing the participants were subjected to the original questionnaire forms again to ensure accurate assessment of retest reliability of the technique. Then they were shown the amended questionnaire forms revisions, they were asked to evaluate these improvements, add some more comments if they had appeared in the course of the second stage.

The time interval between the primary and recurring -diagnosing was on average 4 weeks.

To analyze the results of testing, different methods of statistical data processing were used: analysis of variance, correlation analysis, factor analysis, and analysis of the average figures.

According to the results of testing, primary standardization technique was conducted. Normative scales were designed to test various age groups. Currently, the testing sample has been significantly expanded, it includes a variety of age groups, including younger, middle and high school students. The results of the second wave of testing are currently being processed. Once their treatment is completed, the scales of the normative scores for the other age groups will be submitted.

A comparison of the empirical distribution against the normal theoretical distribution showed a high degree of reliability of the proposed instrument (Figure 3,4).



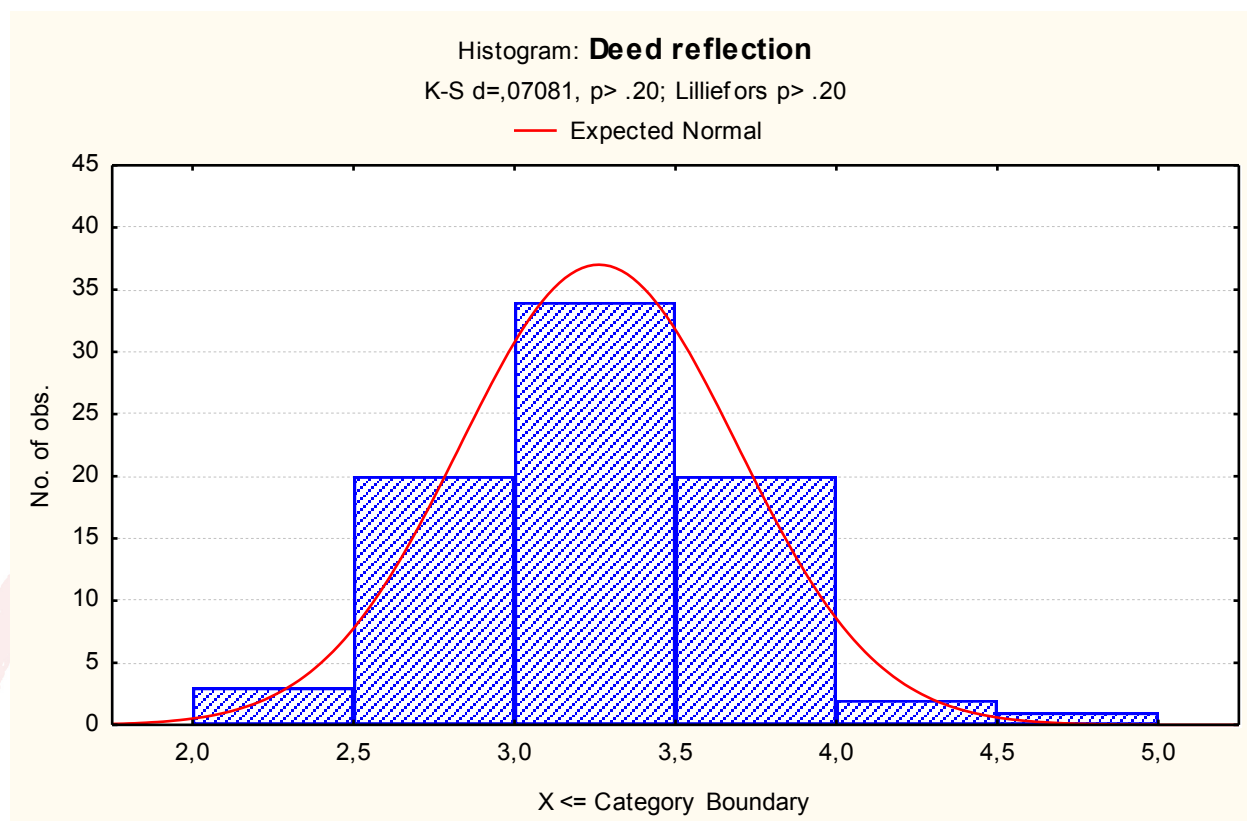

**Fig. 3. The results of analysis of variance estimates as to reflection on action (average totals)**

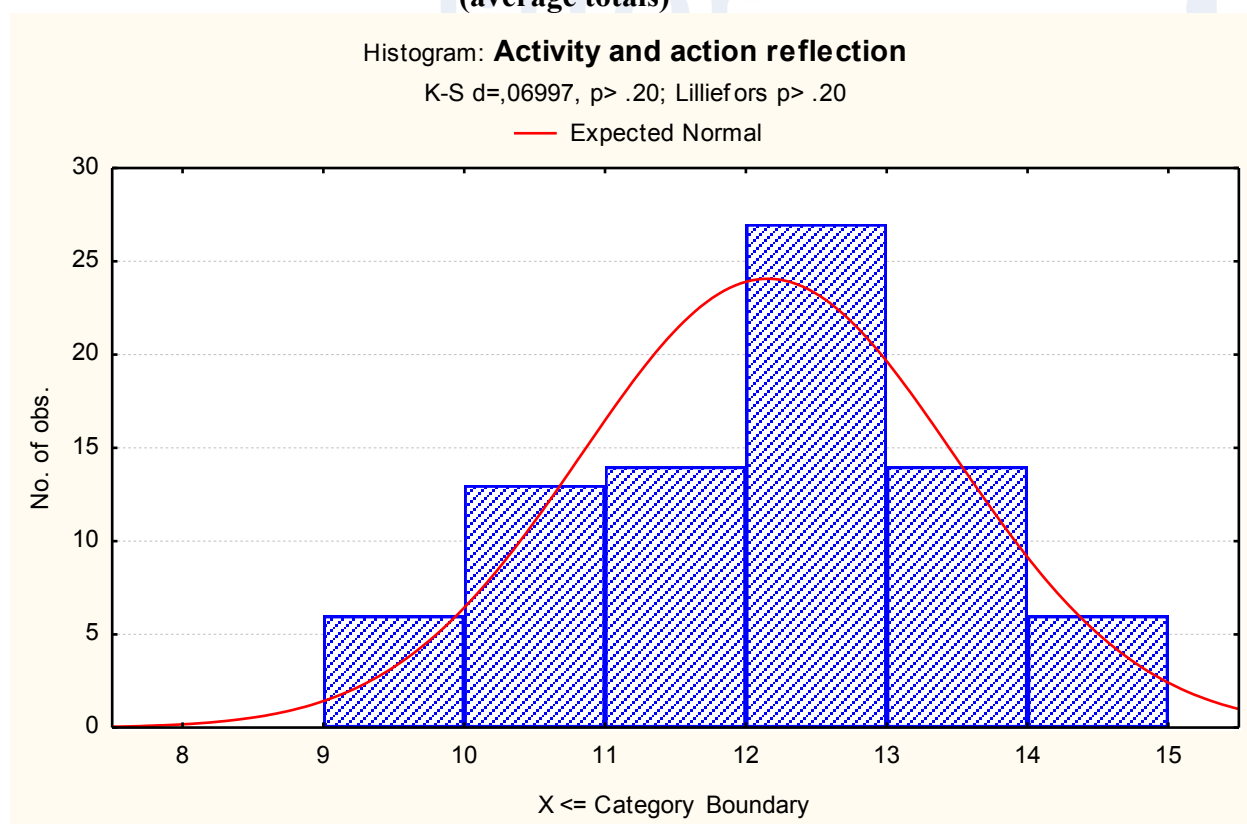

**Fig. 4. The results of analysis of variance estimates of reflection on action and activities (average totals)**

The next step was to examine the retesting reliability of the technique. On the basis of the obtained diagnostic results during the initial and repeated sessions, intercorrelation matrices on various parameters of the reflection on action, activity and reflection on deed were compiled. The relevant data are presented in tables 1 and 2.

Table 1  
**Test-retest results of deed reflection**

<b>Retest \ Test</b>	<b>Need awareness and goal-seeking</b>	<b>Internal and external conditions</b>	<b>Decision-making</b>	<b>Deed program (plan) development</b>	<b>Deed fulfillment</b>	<b>Intermediate results estimation</b>	<b>End results estimation</b>
Need awareness and goal-seeking	<b>0,660**</b>	0,391	0,026	0,142	-0,004	0,157	-0,121
Internal and external conditions estimation	0,443	<b>0,729**</b>	0,349	0,149	0,112	0,271	0,085
Decision-making	0,009	0,349	<b>0,899**</b>	0,389	<b>0,546**</b>	0,712	0,005
Deed program (plan) development	0,085	0,345	<b>0,477**</b>	<b>0,785**</b>	0,027	0,325	0,003
Deed fulfillment	0,351	0,395	0,393	0,232	<b>0,822**</b>	<b>0,522**</b>	-0,007
Intermediate results estimation	-0,111	0,210	0,441	0,254	<b>0,501**</b>	<b>0,702**</b>	0,022
End results estimation	-0,249	-0,143	0,027	-0,205	-0,316	-0,181	<b>0,666**</b>

\*\* correlation is significant on the level of  $p < 0,01$

Table 2  
**Test-retest results of action and activity reflection**

Retest \ Test	Need awareness and goal-seeking цели	Internal and external conditions estimation	Decision-making	Action and activity program (plan) development	Action and activity fulfillment	Intermediate results estimation	End results estimation
Need awareness and goal-seeking	<b>0,603**</b>	0,252	0,290	0,300	0,442	0,408	0,079
Internal and external conditions estimation	0,245	<b>0,599**</b>	-0,069	0,334	0,143	0,273	0,220
Decision-making	-0,080	-0,021	<b>0,593**</b>	0,108	0,136	-0,077	-0,147
Action and activity program (plan) development	0,107	0,482**	0,310	<b>0,724**</b>	0,198	-0,098	0,166
Action and activity fulfillment	0,287	0,467**	0,229	0,321	<b>0,693**</b>	0,101	0,254
Intermediate results estimation	0,016	0,602**	-0,215	-0,084	0,203	<b>0,603**</b>	0,363
End results estimation	-0,174	0,316	-0,055	-0,198	0,173	-0,214	<b>0,686**</b>

\*\* correlation is significant on the level of  $p < 0,01$

These data indicate a high test-retest reliability of the developed toolset in assessing the different levels of reflection on action, activity as well as deed awareness. All correlations between primary evaluations and reassessments of individual reflection indicators are correct at the 1% level of significance ( $p < 0.01$ ). In some cases, they are somewhat lower than those accepted for the test-retest reliability coefficient value (0.70), but this may be due to the limited sample size and to the number of techniques defects that have been eliminated as a result of its initial approval.

Ensuring the validity of the proposed toolset was carried out in several ways.

First, there was a thorough theoretical study of the assessed constructs, then clear-cut definitions of reflection and reflexivity within existing approaches were given, a theoretical model of reflection and reflexivity was developed. Finally, operationalization of the proposed theoretical model was carried out within the specific measurable indicators.

Second, each of the proposed questionnaire items was correlated with the proposed theoretical and operational construct. Services of several experts were enlisted for the assessment of each issue in order to bring force their judgment on the compliance or non-compliance of content as well as wording of the questions to the stated theoretical

principles and indicators at which they were aimed. Comprehensibility of issues for the stipulated by the procedure respondents was also assessed.

Third, a detailed analysis of the internal correlations between separate techniques indicators was carried out. The analysis revealed multiple internal correlations within the structure of the developed tools. The structure and nature of the brought to light correlations give evidence of high internal consistency of the method, its conformity to the theoretical and criterion construct and, consequently, point to a high criterion reliability of the proposed toolset.

Fourth, in the course of testing the participants were offered additional methods on similar in content personality constructs. We selected indicators that allow to reveal links with reflection evaluation when using existing techniques. These were:

- indicators of internality level or subjective control;
- indicators of introversion-extraversion;
- indicators of intelligence development level.

Estimates of reflection, obtained using the developed toolset, yielded the expected values of the correlation links with all the considered indicators;

Fifth, data accumulation on different aspects of training activities productivity of the tested participants is underway. This index is highly significant, because we value reflection and reflexivity in activity and its performance is a parameter of the grade. In-school and intra-university ratings, learning grades, subjective assessments of respondents of their own success in education are examples of such data. The main difficulty here is that the relationship between reflection figures and effectiveness of the activity will be highly dependent on the level of motivation, focus and subjective importance to respondents of those activities for which the final results are estimated. If the educational activity is not relevant to the respondent personally, its effectiveness may be low regardless of the level of reflection. Thus, it requires consideration of a number of additional parameters, but that requires more time.

However, even the present volume of performed work allows us to consider the proposed methodology an effective methodological tool for the study of reflection and reflexivity in action.

The method developed can be recommended to specialists, researchers and practical psychologists as a tool for solving a wide range of problems in school, university and professional education during the individual correction and development work in education, career–guidance, advising students and parents.

Knowledge about the peculiarities of reflexive mechanisms manifestation in the learning activity and the level of reflexivity in the context of the various activity tasks can be used for the organization of individual and differentiated approaches to learning activities and vocational training in schools, universities, vocational schools, corporate universities, workplaces, etc. .

#### **References:**

1. Bizyaeva A.A. Psychology of thinking teachers: pedagogical reflection. - Pskov PSPI them. SM Kirov, 2004. - 216 p.

2. Comprehensive psychological dictionary / Edited by. BG Meshcheryakov, Acad. VP Zinchenko. - Moscow: Prime EVROZNAK, 2003., P. 423
3. Big Russian Encyclopedia. - Moscow: Great Russian Encyclopedia, 2006. - 1887, P. 1319
4. Karpov A.V. Reflexivity as a mental property and method of diagnostics. Psychological Journal. - 2002. - T.24. - № 5. - S. 45-57
5. Karpov A.V. Reflection within subject's metacognitive organization // Reflexive Processes and Control. - 2004. - № 1. V.4. - S. 99-109
6. Karpov, A., I. Skityaeva Psychology of reflection. Moscow: Institute of Psychology RAS, Yaroslavl, "Avers Press", 2002. -304s.
7. Stepanov S.Y. Semenov I.N. Psychology of reflection: issues and research // Questions of psychology. 1985. № 3
8. Philosophical Dictionary. S. 410.
9. Shadrikov V.D. Problems of professional career systemogenesis. - M., 1982.
10. Shadrikov V.D. Professional abilities. Moscow University Book, 2010.

The logo for 'iafor' is centered on the page. It consists of the lowercase letters 'iafor' in a light blue, sans-serif font. The text is enclosed within a large, light blue circular arc that is partially visible at the top and bottom. A faint, larger-scale circular graphic in shades of red and blue is also visible in the background.

*Connectedness between Individual, Community and Environmental Factors in the  
Process of Recovery People Affected Merapi Eruption in 2010*

Mellia Christia\*<sup>1</sup>, Arnfinn Helleve\*<sup>2</sup>

\*<sup>1</sup>Universitas Indonesia, Indonesia, \*<sup>2</sup>University of Oslo, Norway

0464

The Asian Conference on Psychology & the Behavioral Sciences 2013

Official Conference Proceedings 2013

Abstract

The process of recovery of people after exposed by natural disaster usually always seen as individual process. However, recently many research in disaster related found that social, including environmental factors, also influence not only the process of recovery but also how people understand the disaster that they experienced. Indonesia as a country that vulnerable to disaster, it is important to explore the role of connectedness between individual, community and environment in the process of recovery after disaster. This research objective is to determine how is the role of connectivity between people, community and environment in the process of recovery aftermath situation. Qualitative methods with focus group discussion and in-depth interview were the methods to explore people experience with disaster and the influences of community and their relatedness with their environment influence their condition after Merapi eruption. Participant's observation will be supplementary methods that complete the data that gathered from interview and focus group discussion. This research shows the sense of togetherness is very pronounced in comparison with individuality. Responses explain that sense of togetherness was particularly apparent from the public response to disasters; the consequences of the disaster and how social support from the community probably becomes supporting factor for the recovery process after a disaster. Family has important role as one of social support that help people handle disaster situation and cope with its effect. When situation of disaster was unpredictable and beyond human control, being together with family give people sense of security and power, that make people continue living and have hope for the future. Almost all the informants showed their relatedness with mount Merapi in the form of personification (a term or a specific name), the belief of Merapi as part of the "family", and the belief that human behavior towards the environment around Merapi will result in an impact on their lives.

Keywords: Connectedness, disaster, recovery process, people affected disaster, Merapi

iafor  
The International Academic Forum  
[www.iafor.org](http://www.iafor.org)



## 1. Introduction

Disaster is an event that unpredictable, life threatening, and change stable condition of the affected people. Frequency and numbers of people affected by disaster have increased markedly over the last 100 years (Kirmayer, Kienzler, Hamid Afana, & Pedersen, 2010). However, the proportion of people surviving has also arisen which means there are many more survivors who may be affected psychologically by traumatic events.

Bereavement, losing of family and friends, losing of home, jobless, poverty, malnutrition, health risk behavior and psychological disorder are some of the negative impact of disaster to the victim that influence overall mental health condition of the victim. The effect of disaster may be rekindled by new experiences that remind the person of the past traumatic event (Ursano, Fullerton, & Weisaeth, 2007). The impact of disaster is not only to individual or the community that exposed to disaster. The disaster have health impacts at multi layer, individual (physiological and psychological), family, community societal, international and global (Kirmayer et al., 2010). The social impacts of disaster depend on the magnitude, the level of pre-existing infrastructure, the nature of events (human caused or not), response of government, larger society and international response. The impacts of disaster usually more severe in developing countries and it were regarding lack of resources and facilities to respond adequately.

Individual response to traumatic events and the impact of it cannot be separated from socio-cultural influences and the environment in which one lives. Culture influences the individual and collective experience of trauma at many levels: the perception and interpretation of events as threatening or traumatic; modes of expressing and explaining distress; coping responses and adaptation; pattern of help-seeking and treatment response (Kirmayer et al., 2010). Therefore cultural gives meaning to traumatic event itself that make individual, families and communities to make sense of their experience.

Indonesia is located between the continents, Asia and Australia, and flanked by two oceans, Indian and Oceania, making Indonesia vulnerable to disasters. Indonesia's Ministry of Health Crisis Centre (PPK) states there is an increase in the frequency of catastrophic events in Indonesia since 2005. In addition, Indonesia's Disaster Management Agency (BNPB) noted that most of area in Indonesia vulnerable to disaster, which most of them are earthquakes, tsunamis, floods and volcanoes eruption. The disaster was not only in large scale but also in small scale with a high frequency makes the people of Indonesia "living" with the disaster.

As mentioned above, every disaster that happened in community will influence people perception about world and there live, which then implied in there coping strategy and growth after disaster. There are some factors that contribute to that condition, regarding the characteristic of the events itself, for example frequency, magnitude, type of infrastructure, or other factor like psychological factor of individual and community affected by disaster and also type of respond from community, government and international community. Cultural and social context

are another important factors that should be carefully consider in influencing impact of disaster. Research about people of Indonesia affected by disaster will be interesting and important to do, since there will be different experiences and meaning of the event from this population. Universality and specific cultural factor of posttraumatic growth after disaster will be explored regarding their influence in develop and implement intervention and preparation disaster program. People wellbeing and better health condition are the underlying objective to achieve.

This study objective is to explore experiences of people affected disaster in Indonesia and process of growth and recovery after disaster. Result of this study is expected to be the basis for the development of guideline in disaster intervention in Indonesia, which adapts the local cultural context. Intervention program that develop with appropriate cultural context is expected to improve community well being, especially the affected and the Indonesian people in general.

## **2. Method**

This research was conducted in Krinjing Village, in Magelang District, Central Java Province, Indonesia. Krinjing Village is one of the villages that directly affected by volcanic eruption of mount Merapi in October – November 2010. This village is located in the western part of Merapi, 5.2 kilometers from the summit. This study employed qualitative research method with a phenomenology approach, with semi-structure interview and group discussion as data collection methods. The study population included men and women who were affected by Mount Merapi Eruption in 2010. Male and female with different background in age, education and religion were selected in order to provide the opportunity to share different experiences and reflection in the eruption situation. The focus group discussions were conducted to develop interview content, inclusion criteria for interview participant and in ongoing discussions in analyzing the result.

A purposive sampling of 5 females and 11 males were interviewed. All participants were between the ages of 18 – 72 years. Four focus group discussions were conducted in groups of 5: group of elderly people, group of adult male, group of adult female, and group of young people; with the total participation of 21 people. Participants along with their various background and experiences were purposively selected based on information that gathered from the head of village, community leaders, focus group discussion and other participants.

The data collection process was conducted between Augusts – December 2012 (4 months). The researcher was living in the village, stayed over in one of villager residence. Through this process, the researcher was participating in every activity of the villager, and these provide contextual understanding about the social and cultural aspect of the village for the researcher.

## **3. Result**

This research shows the sense of togetherness is very pronounced in comparison with individuality. Responses explain that sense of togetherness was particularly apparent from the public response to disasters; the consequences of the disaster and how social

support from the community probably becomes supporting factor for the recovery process after a disaster.

The majority of informants stated that being with family is important at the time of disaster. Some informants chose to evacuate to a location where their relatives' lives safely from Merapi eruption, despite the available refugee camps provided by the government. It shows that family has important role as one of social support that help people handle disaster situation and cope with its effect. When situation of disaster was unpredictable and beyond human control, being together with family give people sense of security and power, that make people continue living and have hope for the future.

Solidarity expressed by the informants not only related to the family, but also with other fellow villagers. According to some informants, during the period of preparation before the eruption, the community held a joint activity such as prayer, or even patrolling to monitor the activities of Mount Merapi. This is done since a few years ago and people already familiar with this activity. In addition, people also form a forum for disaster relief as a preparation for the Merapi eruption.

Other finding is villagers realize as people who live in proximity of volcanic mountain, they have possibilities to experience volcanic eruption. As people understand their responsibilities, collaboration and togetherness are very important to prepare them handle complex situation. Generally, collective culture creates togetherness with other people in the community as one important factor that support people in coping and recovering from disaster situation (Weiss and Berger, 2010). Previous studies in Japan identified in Japanese case relates to a sense of connection to community and mankind (Weiss and Berger, 2010). Response to disasters and catastrophic impact on the informants in this study were largely led to the community rather than individual level. Most informants' perceived stronger sense of togetherness in the community, especially when they were together, back in the village and rebuild lives after eruption. Cooperation, one of the value that already exist in society, is more strongly felt; in addition to increasing care of others and the spirit of mutual help.

Sense of togetherness is one of the community values that already held by community for some years. After Merapi eruption this value becomes stronger since people feel the importance of being together as survivor of eruption. They have same experience by living in the evacuation camp, eating and sleeping in the same condition. Solidarity is created in difficult situation by helping each other in the process of recovery after disaster. Furthermore, togetherness also gives people some chances to share their problems and discuss how to solve it. Togetherness gives them therapeutic condition that benefited them as member of community. Almost all the informants showed their relatedness with mount Merapi in the form of personification (a term or a specific name), the belief of Merapi as part of the "family", and the belief that human behavior towards the environment around Merapi will result in an impact on their lives. Those beliefs describe in some informants opinion below.

#### **4. Discussion**

Connectedness between individual, community and environment in this research can

be seen from different perspective according to the participants. First, connectedness is the form of togetherness as the positive impact of disaster. The growing strength of togetherness as a community is one of the positive impact felt by the participants in this study. This finding also found in PTG research in Japan that mentioned about the important of social network and family togetherness (Weiss & Berger, 2010). In this study the sense of togetherness also relates community with their nature and Merapi Mountain.

Second, increased sense of togetherness among the villagers and concern for others is a form of dimension relating to others in posttraumatic growth concept. Value of unity and mutual assistance is essentially the value that is already owned by the village community since the beginning of Krinjing village. But after the Merapi eruption, these values are more strongly felt and reflected in their daily behavior. The values of togetherness and mutual help are seen at the time they returned from the evacuation camp and started to rearrange their life. Krinjing village community members help each other to repair houses and villages facilities damaged by the eruption. They also help each other on farming activities, including planting and harvesting. Sense of caring for each other seemed to be felt more strongly. Informants in a focus group discussion concluded this when even though they were living in evacuation camps, sense of concern and caring for each other increase among victims of the eruption. An informant even volunteered at the camp's kitchen that provides food for people in the evacuation camps.

Third, the process of recovery and growth experienced by the participants in this study can be seen from the explanation of their experience of Merapi eruption. This description is one way to understand the world, besides through the sense of personal control and stability over time (Weiss & Berger, 2010), which is a process that occurs in the realm of human cognition. In literature about PTG, it is mentioned that Westerners tend to believe that they have the potential to exert personal control over events compares to Easterners who tend to believe that they should adjust themselves to the situations they encounter (Weiss & Berger, 2010). So in the event of a traumatic event, Westerners tends to feel personal responsibility for what happened, and feel the need to explain the traumatic experiences based on their own behavior. In contrast, Easterners tends to try to find ways to adjust to events that occurred and not feel responsible for the incident. The recovery process also defines not only in individual level, but also on community level. People tend to define their sense of community rather than their sense of individuality when they explaining the process of recovery. For example they feel recovered when the facilities in the village is recovered, so they can help them continuing their live.

Fourth, connectedness in this research also imply in participant explaining about causation of disaster. As Easterners are characterized by collectivism, source of causation is not only on individual but also on collective level. For example, disaster as a result of bad human behavior can be seen as an individual effect (sin), while disaster as a result of the nature of human behavior is a form of collective impact. The last, strong connectivity between individual, community and environment can be seen in response to the government's plan to move the village of Krinjing to safer area. This is because the eruption was happening following a cycle and possibly worsening eruptions may occur in the future. Nevertheless, the idea of relocation is not the first time proposed to the villagers. Since Krinjing experienced frequent Merapi eruption,

the idea of relocation has been introduced but always gets a challenge from the villager. Various reasons are put forward relating to the relationship between society, environment and mount Merapi itself. Several informants mentioned that the difficulty in leaving the village is because the village is their homeland. Other reasons to refuse the relocation are welfare reasons and concerns that the new place is not as fertile as Krinjing and does not have the same natural resources as Krinjing. Strong inter-community relations are also one reason for the refusal. Transfer to other regions cannot guarantee the same placement area for all villagers. This condition is in accordance with the characteristics of Krinjing village as agriculture society that has strong bond with the land, water and environment, as the supporting medium for community agriculture activities. This attachment has been nurtured since hundred years ago, so it is strongly rooted in the community.

Asking Krinjing villagers to move from the land where they were born and always live is not something easy to do. Based on the study conducted previously, the village relocation had been done but it did not improve community life. At that time another disaster befall the people who moved to a new location and caused death. Since then people have the idea that Merapi eruption did not cause casualties. But by the time they moved, they would be strike by a deadly disaster. This is what makes people feel comfortable to stay in an area vulnerable to volcanic disaster, rather than having to live elsewhere.

## References List

- Almedom, A. M. (2005). Resilience, hardiness, sense of coherence, and posttraumatic growth: all paths leading to "light at the end of the tunnel"? *Journal of Loss and Trauma, 10*(3), 253-265.
- Atkinson, P., & Coffey, A. (2003). Revisiting the relationship between participant observation and interviewing. *Inside interviewing: New lenses, new concerns, 415-429.*
- Bourdieu, P. (1984). *Distinction: A social critique of the judgement of taste*: Boston: Harvard Univ Press.
- Caltabiano, M., Sarafino, E., & Byrne, D. (2008). *Health psychology*: Australia: John Wiley & Sons.
- Frankenberg, E., Friedman, J., Gillespie, T., Ingwersen, N., Pynoos, R., Rifai, et al (2008). Mental health in Sumatra after the tsunami. [AJPH.2007.120915 pii ;10.2105/AJPH.2007.120915 doi]. *Am.J.Public Health, 98*(9), 1671-1677.
- International Federation of Red Cross and Red Crescent Societies (2000). *World disasters report: A focus on public health*. Dondrecht, The Netherlands: Martinus Nijhoff.
- International Federation of Red Cross and Red Crescent Societies (2011). *World Disaster Report 2011: Focus on hunger and malnutrition*. In L. Knight (Ed.). Lyons, France: International Federation of Red Cross and Red Crescent Societies.
- Irmansyah, I., Dharmono, S., Maramis, A., & Minas, H. (2010). Determinants of psychological morbidity in survivors of the earthquake and tsunami in Aceh and Nias. *International Journal of Mental Health Systems, 4*(1), 1-10.



- Joseph, S., & Linley, P. A. (2008). *Trauma, recovery, and growth: Positive psychological perspectives on posttraumatic stress*: John Wiley & Sons Inc.
- Kirmayer, L. J., Kienzler, H., Hamid Afana, A., & Pedersen, D. (2010). Trauma and disasters in social and cultural context.
- Kun, P., Han, S., Chen, X., & Yao, L. (2009). Prevalence and risk factors for posttraumatic stress disorder: a cross sectional study among survivors of the Wenchuan 2008 earthquake in China. *Depression and anxiety*, 26(12), 1134-1140.
- Kvale, S., & Brinkmann, S. (2009). *Interviews: Learning the craft of qualitative research interviewing*: SAGE Publications, Inc.
- Malterud, K. (1993). Shared understanding of the qualitative research process. Guidelines for the medical researcher. *Family Practice*, 10(2), 201.
- Malterud, K. (2001). Qualitative research: standards, challenges, and guidelines. *The Lancet*, 358(9280), 483-488.
- National Agency of Disaster Management (2010). *National Disaster Management Plan 2010-2014*. Jakarta.
- Norris, F. H., Galea, S., Friedman, M. J., Watson, P.J. (2006). *Methods for disaster mental health research*. New York: Guilford Press
- Patton, M. Q. (2002). *Qualitative research & evaluation methods*. (3rd ed.), XXIV, 598, [565] s. California: Sage Publication
- Raphael, B., Lundin, T., & McFarlane, C. (1989). A research method for the study of psychological and psychiatric aspects of disaster. *Acta psychiatrica scandinavica*, 80(S353), 1-75.
- Reyes, G., & Jacobs, G. A. (2006). *Handbook of international disaster psychology: fundamentals and overview*. Westport: Praeger Perspectives
- Souza, R., Bernatsky, S., Reyes, R., & de, J. K. (2007). Mental health status of vulnerable tsunami-affected communities: a survey in Aceh Province, Indonesia. [10.1002/jts.20207 doi]. *J.Trauma Stress*, 20(3), 263-269.
- Splevins, K., Cohen, K., Bowley, J., & Joseph, S. (2010). Theories of posttraumatic growth: Cross-cultural perspectives. [References]. [<http://dx.doi.org/10.1080/15325020903382111%5D>]. *Journal of Loss and Trauma*(3), 259-277.
- Tang, C. (2007). Posttraumatic growth of southeast Asian survivors with physical injuries: Six months after the 2004 southeast Asian earthquake-tsunami. *Australasian Journal of Disaster and Trauma Studies*, 2, 2007-2001.
- Tedeschi, R. G., & Calhoun, L. (2004). Posttraumatic growth: A new perspective on psychotraumatology. *Psychiatric Times*, 21(4), 58-60.
- Tedeschi, R. G., & Calhoun, L. G. (1996). The Posttraumatic Growth Inventory: Measuring the positive legacy of trauma. *Journal of Traumatic Stress*, 9(3), 455-471.
- Tedeschi, R. G., & Calhoun, L. G. (2004). " Posttraumatic Growth: Conceptual Foundations and Empirical Evidence". *Psychological Inquiry*, 15(1), 1-18.
- United Nations Of Development Program (2011). *Human Development Report 2011: Sustainability and Equality A Better Future For All*. New York: United Nations Development Program (UNDP).
- Ursano, R. J., Fullerton, C. S., & Weisaeth, L. (2007). *Textbook of disaster psychiatry*: Cambridge Univ Pr.
- Weiss, T., & Berger, R. (2010). *Posttraumatic growth around the globe: Research findings and practice implications*. New Jersey: John Wiley and Sons.



*Modeling Choice Behavior of Delivery Provider of Online Auctioneer*

Yi-Wen Kuo\*<sup>1</sup>, Yu-Kai Huang\*<sup>2</sup>

\*<sup>1</sup>Shu-Te University, Taiwan, \*<sup>2</sup>Nanhua University, Taiwan

0474

The Asian Conference on Psychology & the Behavioral Sciences 2013

Official Conference Proceedings 2013

Abstract

Digital technology has provided a new paradigm of our society and changed our lives interaction with the Internet. As an efficient and flexible sales channel, companies can use auction sites to liquidate unwanted inventory, as well as to assist in pricing new products, acquiring new markets for low-margin items, and reaching markets that would be too costly using traditional distribution methods. Online auction is a new type of shopping methods due to the convenient internet. In Taiwan, many e-commerce-related deliveries are operated by third party logistics providers. In the electronic commerce dealing, the service of delivering consumers' orders to buyers can be seen as the last mile of logistics service, especially for the individual online auction through the C2C transaction. This paper explores the structure of logistic for retailing delivery and post service for online auction. The data were collected from 317 surveyed students who have ever purchased goods via online auction. We divided these respondents into two distinct segments by shopping frequency for online auction. Then we applied multinomial logit model to understand what relevant factors would affect online auction sellers' choice behavior of logistic in delivery service. Finally, we discussed the findings from managerial perspective and suggest directions for future research.

**Keywords:** retailing delivery, choice behavior, logit model

## **1. Introduction**

Digital technology has provided a new paradigm for our society and changed our lives through interaction with the Internet. As an efficient and flexible sales channel, companies can use auction sites to liquidate unwanted inventory, as well as to assist in pricing new products, acquiring new markets for low-margin items, and reaching markets that would be too costly using traditional distribution methods. The development of e-commerce is an efficient business model which enables new relationship between consumers and suppliers. In particular, the online auction market is growing between 50% and 60% and obviously becoming a noticeable market. However, how to deliver goods to customers becomes one of the challenges for the sellers. In Taiwan, convenience stores have integrated the e-commerce with the logistics system of convenience stores to a new retail delivery model: "Online shopping in an electronic store and pick-up goods in a convenience store".

The retailing delivery (RD) system provides an easy online shopping process, safe method of payment and quick delivery service for e-retailing (Huang & Feng 2009). The main retailing delivery providers in Taiwan are 7-11.com and CVS.com. Previous researches proposed that the location of the convenience store and logistics service quality are major factors to influence consumers' choice behavior (Huang, Kuo & Xu, 2009). Since customers are the main resources of gaining profits, how to develop the differentiating strategies to maintain the existing customers with customer satisfaction and to obtain new customers becomes an important issue for convenience stores (Sharma, Grewal, and Levy, 1995). This paper had two aims: one is to examine the factors influencing the choice behaviour of retailing delivery service; the other is to describe a way in which a logit model is used to develop a marketing strategy for retailing delivery service choice behavior in the logistics market.

## **2. Basic idea and framework for retailing delivery of electronic commerce**

Online shoppers (consumers) make their orders at their office or home anticipating quicker delivery than offline purchasing, and timely delivery at convenient times. Feng and Huang (2009) pointed out that consumers can place orders at any time any where through the Internet in the online environment, so that the orders are unpredictable and dynamic, but the delivery service response is expected to be fast. Therefore, e-retailing needs a quick-response logistics system to support the order deliveries.

In Taiwan, most of the e-commerce-related delivery is operated by the third-party logistics provider (3PL). Because of the need for an information system and timely delivery system, low logistics operations cost and there are many convenience stores in Taiwan, 3PL providers have had to improve the flow of information both internally and externally and integrate their logistics services into the retail delivery (RD) provided by convenience stores. A new RD model proposed: "Online shopping with pick-ups at convenience stores." The RD services have made many remarkable successes in portal sites such as Yahoo.com and Pchome.com.

The new RD providers in Taiwan are 7-11.com and CVS.com. CVS.com is a joint venture by four convenience stores including Family.com, Hi-Life.com, Okcvs.com and Nikomart.com that began service in the beginning of 2000, while 7-11.com joined the market at the end of 2000. Because the safe payment method and the quick delivery, RD services by convenience stores have played an important role in the e-commerce logistics in Taiwan. The relationship of online auction of RD includes three functions: (1) e-map, (2) delivery system and (3) pick-up point.

The RD system provides an easy online shopping process, a safety payment method, pick-up points of convenience stores and quick delivery service for online consumers. The RD system has two characteristics: consumers can shop online even without a credit card and it provides consumers with a self pick-up approach through convenience stores. The procedure that combines online auction with online sellers, online buyers and RD system is illustrated below:

#### 1. Online shopping

The online sellers in Taiwan mostly have provided RD service (e.g., home delivery and pickup at the convenience store). In the part of pick-up at the convenience store, the sellers have the right to decide their RD provider, 7-11.com or CVS.com. Then the online consumers trade with the sellers who provided the pick-up point of convenience store where the consumers want to pick-up goods.

#### 2. Choose a pick-up point

After finishing the transaction, 7-11.com or CVS.com will be shown on the website. The buyer should select the pick-up point on the e-map provided by the RD system.

#### 3. Packing process

After the seller confirms the orders, the seller would finish the packing process (e.g., pick goods, print invoice and package), and dispatch the goods to the selected convenience store (e.g., Family.com, Hi-Life.com, Okcvs.com), that is provided by CVS.com system or wait the delivery centre to receive the goods and transport the goods to the delivery centre, that is provided by 7-11.com system.

#### 4. Delivery process

The delivery centre of CVS.com system collects the orders from different convenience stores and transports the orders to the convenience store (pick-up point of the orders) and then replies the completed information to the system and online sellers. The delivery centre of 7-11.com system also receives information from sellers' place and transports the orders to the 7-11 convenience stores (pick-up point of the orders) and then replies the completed information to the system and online sellers.

#### 5. Picking-up Goods

According to the reply information, the system will notify the buyer by e-mail or cell phone message about the pick-up status of goods.

In General, the consumers order the goods on D day the seller will proceed to pack and dispatch the goods on the D+1 day, and the consumers can pick the goods from the convenience store on the afternoon of the D+3 day, or the D+5 day if there it involves a weekend. The procedure that combines online auction with online sellers, online buyers, and RD system is illustrated below and shown in Figure 1.

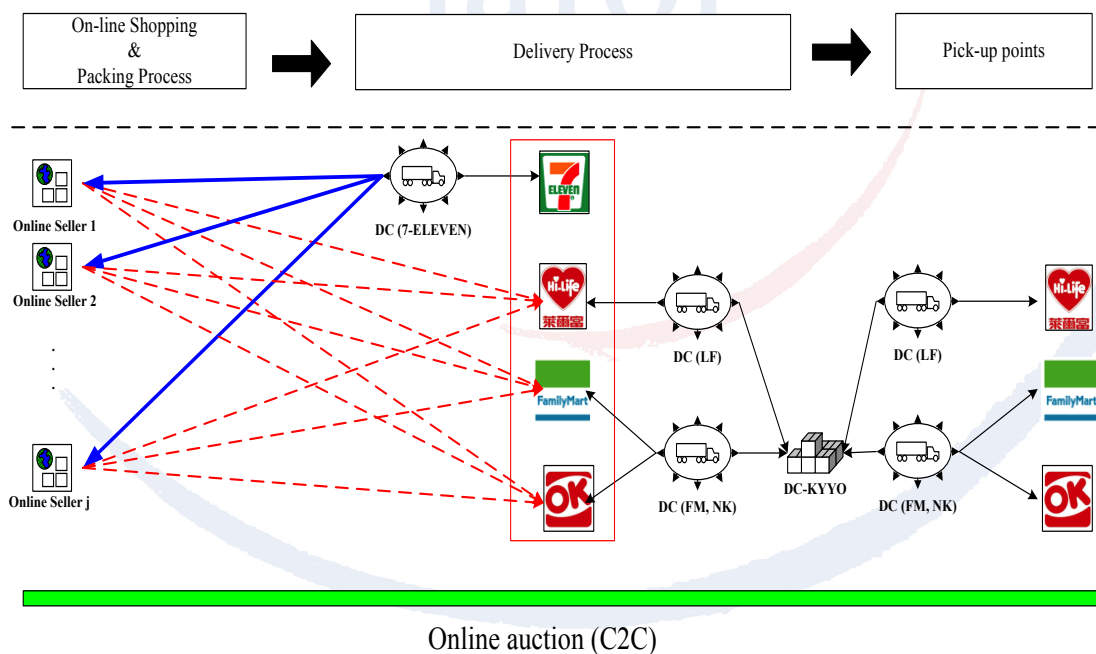

Figure 1. Relationship of online auction of RD

### 3. Methodology

Choice behavior can be characterized by a decision process, which is informed by perceptions and beliefs based on available information, and influenced by affect, attitudes, motives, and preferences. The logit model is based on the notion that an individual derives utility by choosing an alternative. The utilities  $U$  are latent variables and the observable preference indicators  $y$  are manifestations of the underlying utilities. The utilities are assumed to be a function of a set of explanatory variables  $X$ , which describe the decision-maker  $n$  and the alternative  $i$ . The resulting utility equation can be written the following:

$$U_{in} = V(X_{in}; \beta) + \varepsilon_{in} \quad (1)$$

where  $U_{in}$  is the utility of alternative  $i [i = 1, \dots, j_n]$  for decision-maker  $n [n = 1, \dots, N]$  ( $U_n$  is a vector of utilities for decision-maker  $n$ );  $X_n$  is a vector of explanatory variables describing alternative  $i$  and decision-maker  $n$  ( $X_n$  is a matrix of explanatory variables describing all alternatives and decision-maker  $n$ );  $\beta$  is a vector of unknown parameters;  $V$  (called the systematic utility) is a function of the explanatory variables and unknown parameters  $\beta$ ; and  $\varepsilon_{in}$  is a random disturbance for  $i$  and  $n$  ( $\varepsilon_n$  is the vector of random disturbances, which is distributed  $\varepsilon_n \sim D(\theta_\varepsilon)$ , where  $\theta_\varepsilon$  are unknown parameters).

Decision-maker  $n$  chooses  $i$  if and only if  $U_{in} \geq U_{jn}$  for all  $j \in C_n$ , where  $C_n$  is the set of  $J_n$  alternatives faced by  $n$ . The choice probability equation is then:

$$P(i | X_n; \beta, \theta_\varepsilon) = \text{Prob}[U_{in} \geq U_{jn}, \forall j \in C_n]. \quad (2)$$

The utility of alternative  $i$  prefer the utility of alternative  $j$  in individual  $k$  can be showed as follow:

$$U_{ik} > U_{jk} \quad i, j \in A_k \quad i \neq j$$

The utility function of  $U_{ik}$  can be showed as follow:

$$U_{ik} = V_{ik} + \varepsilon_{ik} \quad (3)$$

The probability choice behavior model can be showed as follow:

$$\begin{aligned} P(i | A_k) &= P(U_{ik} > U_{jk}, \forall j \in A_k) \\ &= P(V_{ik} + \varepsilon_{ik} > V_{jk} + \varepsilon_{jk}, \forall j \in A_k) \\ &= P(V_{ik} - V_{jk} > \varepsilon_{jk} - \varepsilon_{ik}, \forall j \in A_k) \end{aligned} \quad (4)$$

It assumed that all of the disturbances are independently and identically distributed (IID) and have the same Gumbel distribution, the GMNL model as follow:

$$P(i | A_k) = \frac{e^{V_{ik}}}{\sum_{j_k=1}^{J_k} e^{V_{jk}}} \quad (5)$$

where  $J_k$  denotes the number of alternative  $A_k$ .

#### 4. Data and analysis results

The target sample in this study is the online-shoppers who have ever purchased online auction market, and pick-up goods at the convenience store. The data used in this study were collected via a Web survey. In order to reduce the possibility of multiple submissions by one person, cookie technology was used to ensure that each respondent answered the questionnaire only once. During the survey of five-week period, in the final survey we retrieved 317. Among the sample data, more than 65.2% of respondents are female, 61.1% are 18-29 years old. More than 71.4% of the respondents are unmarried. In terms of education level, 55.3% of respondents are educated at the college/university level. In terms of income level, more than 33.3% makes less than NT\$ 30,000 per month. More than 41.3% of respondents live in northern Taiwan. Furthermore, about 31.2% of the respondents are students. About 67.7% of the respondents have 3 years or more experience in online shopping when they fill in the questionnaire.

Discrete choice analysis assumes that decision-makers select the alternative with the highest utility. Thus, the utility of an alternative includes a deterministic portion which is a function of the attributes of the alternative and characteristics of the decision-maker and a random component which represents unobservable components of the utility function. The characteristics variables of participants are socioeconomic variables, like gender, age, marital status, education level, monthly income level, area, and occupation. In this research, we use the binary logit model to analyze items that influence customers in choosing the post or retailing delivery service. This choice set of post or retailing delivery is shown as Figure 2.



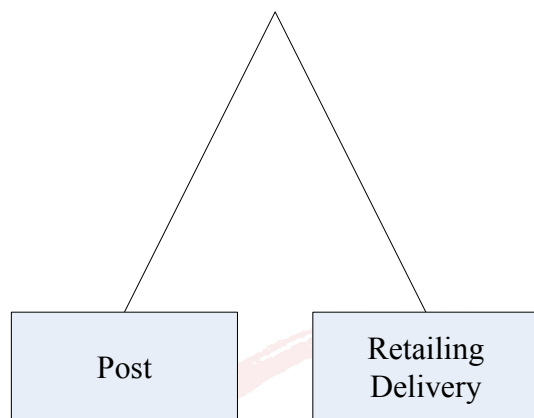

Figure 2 The choice set of post or retailing delivery

The choice model is estimated using the NLOGIT 3.0 software and the Maximum Likelihood method. All estimates have plausible signs (except the dummy for marital status, education, area and occupation in the model for respondents). The costs were combined with income variables in various ways. The estimated coefficients for the binary logit model are shown in Table 1.

Table 1 The Estimation Results of Binary Logit Model

Variable	Model Structure		
	Binary Logit Model		
	Coefficient	t-value	P-value
Constant (Post)	0.18387	1.16761	0.24297
Attributes of respondents			
Delivery charge/INCOME	-0.80720	-1.82019**	0.06873*
Dummy for Area-of-Southern Taiwan	0.57759	2.79906**	0.00513*
Dummy for Occupation-of-Employee of company	-0.36246	-1.80812**	0.07059*
Latent variables for LSQ			
Information Quality	0.72766	2.08570**	0.03701*
Convenience	1.74381	5.26166**	0.00000*
Observations	317		
Log-likelihood	-397.9004		
“Rho <sup>2</sup> ” w.r.t. 0	0.1898		

Notes: \*\* t-value >1.645; \* p<0.1.

The likelihood ratio for the best results of binary logit model is 0.1898. That means the variables which have significant effect on the binary logit model have powerful explanation. And the calibration results reveal that: the variables for gender, age, marital status, and education can be removed, because their estimates are clearly insignificant now. The variables for area have a negatives impact on retailing delivery service choice behavior: people live in southern Taiwan prefer to post delivery service

to be the retail delivery service, possibly because the post in southern Taiwan play more importance role than convenience stores. Employees of a company have a higher probability to choose retail delivery service, implying that they consider not only the brand preference but also the distance from the living circle.

In this study we present the application results of applying the choice behavior. These results are compared to actual outcomes. We also report the results of policy simulation runs in which one variable is changed and everything else is assumed to remain constant. All simulation results reported here are obtained using the binary logit model. Below are the outcomes for simulations in each of which a single (policy) variable is changed. The model system has been used for the following policy runs: a 10% (30%) increase (decrease) in the retail delivery (post). The main outcomes for this system are in Table 2. The results are expressed as percentage differences relative to the base run. These results therefore give predictions of the impact of the respective policy measures only. The choice behavior model itself is sensitive to changes in price. For retail delivery and post, to decrease 10% of price construct will increase the market share by 1.848% and 2.121%. If retail delivery decrease 30% of price construct will increase the market share by 5.367%.

Next, we analyze elasticity issue using by the results of logit model. The Price elasticity<sup>1</sup> of demand measures the percentage change in quantity demanded caused by a percent change in price. As such, it measures the extent of movement along the demand curve. The cross elasticity of demand or cross-price elasticity<sup>2</sup> of demand measures the responsiveness of the demand for a good to a change in the price of another good. It is measured as the percentage change in demand for the first good that occurs in response to a percentage change in price of the second good. According to the (6) and (7), the direct elasticity for both the post and retail delivery were -0.031 and -0.382 respectively; and it was obvious that the impact to market share from retail delivery sales price would be larger. Cross elasticity for post and retail delivery were 0.035 and 0.193 respectively; and this was obvious that the price rising for the post had less impact to the market share of retail delivery; nonetheless, the price rising for retail delivery would influence more on the market share for post.

Table 2 Simulation results for different price policies

<sup>1</sup> The formula used to calculate the coefficient cross elasticity of demand is:

$$E_d = \frac{P}{Q_d} \times \frac{dQ_d}{dP} \quad (6)$$

<sup>2</sup> The formula used to calculate the coefficient cross elasticity of demand is:

$$E_{XY} = \frac{\frac{\Delta Q_{dX}}{Q_{dX}}}{\frac{\Delta P_Y}{P_Y}} = \frac{\Delta Q_{Xd}}{\Delta P_Y} \cdot \frac{P_Y}{Q_{Xd}} \quad (7)$$

	retail delivery	post
base	35.53%	64.47%
retail delivery		
Price↑10%	34.88% (↓1.832%)	65.12 % (↑1.832%)
Price↑30%	32.86% (↓5.783%)	67.14 % (↑5.783%)
Price↓10%	33.47 % (↑1.848%)	66.53% (↓1.848%)
Price↓30%	35.27 % (↑5.367%)	64.73% (↓5.367%)
psot		
Price↓10%	37.66% (↓2.121%)	62.34 % (↑2.121%)
Price↓30%	35.24% (↓6.434%)	64.76% (↑6.344%)

## 5. Conclusions and limitations

Digital technology has provided a new paradigm of our society and changed our lives interaction with the Internet. As an efficient and flexible sales channel, companies can use auction sites to liquidate unwanted inventory, as well as to assist in pricing new products, acquiring new markets for low-margin items, and reaching markets that would be too costly using traditional distribution methods. Online auction is a new type of shopping methods due to the convenient internet. In Taiwan, many e-commerce-related deliveries are operated by third party logistics providers. In the electronic commerce dealing, the service of delivering consumers' orders to buyers can be seen as the last mile of logistics service, especially for the individual online auction through the C2C transaction. This paper explores the structure of logistic for retailing delivery and post service for online auction.

According to analysis results, market share for this post was about 65% and that for the retail delivery was about 35%. Direct elasticity for both the post and retail delivery was -0.031 and -0.382 respectively; and it was obvious that the impact to market share from retail delivery sales price would be larger. Cross elasticity for post and retail delivery were 0.035 and 0.193 respectively; and this was obvious that the price rising for the post had less impact to the market share of retail delivery; nonetheless, the price rising for retail delivery would influence more on the market share for post.

From the simulation results, we know information quality and convenience are more sensitive to changes in the market share. The present findings have both managerial and research implications. For managers of the delivery providers, how to offer the consumer satisfied quality becomes the essential running methods of the service

industry businessmen. Therefore, establishing a great relationship with customers has become very important. Moreover, how to maintain a great relationship with customers also becomes an important issue for the service industry businessmen. Our data are all focused and gathered in Taiwan, so the conceptual framework proposed by us is suitable for Taiwanese people. But consumers with different culture may not be explained by this conceptual framework. Future research can collect samples from other countries and compare the difference.

## Reference

[1] Y. K. Huang and C. M. Feng (2009), A structural equation model of management strategies and firm performance: a case study of logistics service quality on home delivery, *International Journal of Electronic Customer Relationship Management*, Vol. 3, No. 3, pp.281–300.

[2] Y. K. Huang, Y. W. Kuo and S. W. Xu (2009), Applying Importance-Performance Analysis to Evaluate Logistics Service Quality for Online Shopping among Retailing Delivery, *International Journal of Electronic Business Management*, Vol. 7, No. 2, pp. 128-136.

[3] Sharma, A., Grewal, D. and Levy, M. (1995), The customer satisfaction/logistics interface, *Journal of Business Logistics*, Vol. 16, No. 2, pp. 1-22.

[4] Y. K. Huang and C. M. Feng (2009), A catastrophe model for developing loyalty strategies: a case study on choice behaviour of pick-up point for online shopping, *International Journal of Services Operations and Informatics*, Vol. 4, No. 2, pp. 107-122.

*Applying Technology-Mediation to Assist Junior College Students to Learn Japanese  
as 2<sup>nd</sup> Language and Improve the Efficiency*

Shih Hsiu-Ching

National Taiwan Normal University, Taiwan

0486

The Asian Conference on Psychology & the Behavioral Sciences 2013

Official Conference Proceedings 2013

Abstract

This study is based on college students' as study objects and attempting to explore the efficiency of applying technology-mediation method to learn a second foreign language. The research includes two experiments. In the first experiment, students are divided into high score group and low score group who undergo the learning effects test of Japanese language by using the e-smart pen. In the second experiment, which based on the first one, students use e-smart pen plus internet learning to investigate the efficiency of learning Japanese as second language. The result of the first experiment indicates a determining impact. Moreover, In comparison with the results of both experiments, it shows that low score group students are more benefited by the assist of using e-smart pen; the second experiment indicates that the Japanese vocabulary and conversation capability can be enhanced through the use of e-smart pen. However, internet learning is more useful to increase vocabulary ability. These findings indicate that under the technology-mediation, learners can not only complete the learning activities, but also obtain better learning effects.

**Keywords :** Technology-Mediation, e-smart pen, Japanese learning

## **I. Research motive and purpose**

In the technology-mediation learning environment is based on the theory of learner-centered, Fu-yun Yu (2003) pointed out that the purpose of the technology-mediation is in order to enrich the students' learning experience, therefore have to rely on teachers utilize different teaching strategies, teaching activities of the message re-engineering and knowledge construction, so that passive learning will be transformed into active learning. Constructivism emphasizes:

1. Individual learning must construct their heredity, experiences, perspectives, backgrounds, talents, interests, capacities, and needs) with a focus on learning.
2. Focus on learning, that is, the best available knowledge about learning and how it occurs and about teaching practices that are most effective in promoting the highest levels of motivation, learning, and achievement for all learners). (McCombs and Whisler, 1997; Chang, 2009b).

By the constructivist view, teaching strategies, development of the technology-mediation, which consider student characteristics and teaching conditions, it is the focus of recent study. For this study one of motivation to explore that is the integration of digital technology into the mode of a second foreign language teaching steps, teaching methods and making a meaningful learning-based study.

Tsai ( 2006) pointed out that technology-mediation teaching strategies, systematic teaching process to achieve a specific teaching objective, to digital, including teaching methods, teaching media, and teaching activities. The technology-mediation can consider the characteristics and needs of learners, arrange appropriate teaching materials and situational meaningful learning activities to meet the learning theory.

Alavi and Leidner (2001) they think that the effectiveness of learning through an explicit consideration of relationships among technology capabilities, instructional strategy, psychological processes, and contextual factors involved in learning (Yun-pei, Chen, 2006). Empirical research, scholars believe that the use of information technology will enhance the effectiveness of learning (Alavi, 1994; Marki et al., 2000; Alavi, Wheeler and Valacich, 1995; Yun-pei Chen, 2004) Especially the teaching content into the concept of "what students learn?" by the "teachers what to teach?" The role of teachers from imparting knowledge to the role of knowledge provider and subsidiary in accordance with students' personal characteristics; Learning of students from passive recipients of knowledge into an active, positive attitude to autonomous learning. The technology-mediation mechanisms have been integrated into the concern about the learners themselves, to explore the potential and motivation of the learners themselves, from teacher-led to student interaction, and manage teaching methods and means to achieve truly stimulate students' willingness to learn and motivation.

In addition, the technology-mediation deeply affects autonomous learning theories. In digital teaching, students learning to active learning, self-learning, and learners can take the initiative to arrange the learning environment, planning inquiry approach, analyze problems, solve problems, and to monitor the learning progress in a timely



manner and effective regulation of learning methods. Related to motivation, self-planned, self-regulation and self-directed learning space promote learning effectiveness. In other words, the technology-mediation, autonomous learning requirements given the self-directed learning space to go to multiple learning resources from a limited textbooks, educational thought and method of conversion (paradigm shift). Go to the learner center from the Teachers' Centre, learning from a one-way transfer of knowledge to the self-exploration (Zhang, Pan and Peng, 2007).

Another will be the knowledge era learning mode in response to the Information Age, the traditional teaching methods cannot meet the needs of students, combined with the autonomous learning theory redevelopment to based on problem-oriented learning. Second foreign language through digital technology into teaching mode, the effective integration of life science and technology, life and culture information, entertainment expansion of knowledge and cultural horizons, not only between theory and practice in the learning material, and also in the life and culture effective link between language and situations, life experiences can strengthen the learning process, and promote second language learning outcomes.

In this study, experiments in two stages, the first stage of the experiment through technological teaching aids, e-smart pen teaching tool to explore e-learning effect of groups (high and low group) for different learning groups. The second stage of teaching experimental basis in the first stage, to explore learners who used e-smart pen and internet e-learning, that create a digital teaching situation and the effects of the Japanese learning.

Based on the research motive and purpose of the foregoing, the following two issues to be answered:

- (1) Learners in Japanese teaching situation, teaching tool (e-smart pen), and integrated into the life and culture courses whether it can effectively improve the learning achievements of the Japanese?
- (2) Learners in the Japanese language teaching situation, combined with the Internet learning behavior, and integrated into the life and culture courses, can effectively improve the learning achievements of the Japanese?

## **II. Experimental Design**

Course content will be e-textbooks, living Japanese study as a research subject, the living language, life and culture, and other related information into the curriculum planning; And e-courses on various themes of daily life close, contextual learning experiment, measurement facilities and at the end of the course. Explore whether the e-course can really enhance the Japanese learning effectiveness of different level students.

### **A. Experiment I**

- a. This experiment as the sample in accordance with the following experimental course design and teaching, foreign language students in subjects after Pre-experiment survey (tests), divided into treatment and control groups, e-situational experimental courses.
- b. Course planning

In this study, the Japanese e-situational learning course content as a research subject, e-smart pen, on the life and culture courses, sightseeing, hotels, and other ("Hotel basic Japanese), includes lodging registration, check-out the registration, a total of two units.

c. Pre-experiment survey

1. The purpose of:

- a) Confirm the content of textbooks, and to distinguish the level of students in Japanese.
- b) Divided into two groups for the experimental study of high score group and low score group in each class in accordance with the learning ability.

2. During the period: Two weeks.

3. Objects: Five-year junior school the department of foreign language students (two classes of 47, a total of 94 people).

4. Based on midterm results as to distinguish between students' Japanese standard, more than 70 points for the high score group; 60 points or less for the low-scoring group (full score is 100).

5. Results: foreign language students in (A, B two classes, the high score group with 18 people and the low score group with 21 people)

d. E-teaching experimental design

An experimental method applied to measured:

During the period: Two weeks

e. The purpose of: The basis of test results Pre-experiment survey, divided into two groups of high score group and low score group. The department of foreign language students (A, B two classes, the high score group with 18 people and low score group with 21 people).

Material: Daily life in Japan, with range of textbooks "Go! Japanese I, II(Daxin Publisher)".

Methods: This experimental study method, divided into treatment groups and control group were observed e-smart pen integrated into the course, to explore the department of foreign language students (high / low score group) and their learning effect.

f. The experimental results

To explore the effect of integrating "e-smart pen" into curriculum, the High-score and Low-score group that recognized by pre-experiment survey are used to test whether both vocabulary and conversation disciplinary capability are significant different between treatment group and control group. Since the test result of homogeneity of variance assumption is significant at 0.05, it followed with t-tests for difference discussion on two Japanese capabilities.

From the results of t-tests in Table 1, we can see that neither vocabulary nor conversation capability is significant different for Class A (controlled group) and Class B (treatment group) from High-score group. It means that, for those objects from High-score group, no matter "e-smart pen" is introduced in Japanese learning process or not, two Japanese capabilities improve with no doubt.

TABLE 1. MEAN DIFFERENCE TEST OF VOCABULARY AND CONVERSATION CAPABILITY FOR CLASS A AND B FROM HIGH-SCORE GROUP (EQUAL VARIANCE ASSUMED)

	Class A Mean (variance)	Class B Mean (variance)	Gain	t	Critical Value	p
vocabulary average score	91.73	96.5	4.77	-0.819	2.052	0.419
conversation average score	97.36	94.17	3.19	1.573	2.052	0.127

( Full score is 100,Seperation point is 70 for high and low group )

Same mean difference test result of vocabulary and conversation capability for Class A (controlled group) and Class B(treatment group) from Low-score group is summarized in Table 2. As we can see, both t-tests of vocabulary and conversation capabilities are significant due to the corresponding p-values. There's strong evidence to infer that "e-smart pen" plays an important role to help those objects who lack of incentive on language learning from Low-score group.

TABLE 2. MEAN DIFFERENCE TEST OF VOCABULARY AND CONVERSATION CAPABILITY FOR CLASS A AND B FROM LOW-SCORE GROUP (UNEQUAL VARIANCE ASSUMED)

	Class A Mean (variance)	Class B Mean (variance)	Gain	t	Critical Value	p
vocabulary average score	33.21	58.45	25.24	-2.481	2.021	0.0174
conversation average score	48.83	83.68	34.85	-4.029	2.048	0.0004

## Experiment II

### a. Course planning

In course planning through technology-mediation (e-smart pen, internet) to introduce the life and culture of the tourist hotels and other courses ("Hotel basic Japanese), includes lodging registration out registration, idioms and tourist hotels, a total of three units.

### b. Pre-experiment survey

(1)The purpose of: To confirm the textbook content is not affected by the experience students have knowledge areas, according to the survey results, distribution of students to each group.

(2)During the period: Two weeks.

- (3) Objects: The institute of Technology, department of foreign language students, a total of 187 people.
  - (4) According to the preliminary findings to develop learning assessment is based, including vocabulary, phrases for conversation, surveying.
  - (5) Results: elected prior knowledge is not limited by the range of students, a total of 160 people.
- c. Teaching experiments and experimental plan
- (1) The purpose of: to understand the students who experienced the teaching of technology-mediation before and after the Japanese scores changing circumstances.
  - (2) Period: 2 months.
  - (3) Objects: prior findings, were randomly assigned to four groups of A, B, C, D.
    - (i) Experimental Variables  
Independent variables 1 : e-smart pen [with, without]; Independent variables 2 : internet [with, without].
    - (ii) Groups  
On two independent variables (e-smart pen, the internet), and whether the learning tool, composed of four different groups were: Group: A without internet +with e-smart pen group; group B: without internet + without e-smart pen group; C group: internet + e-smart pen group, group D: with internet +without e-smart pen group.
  - (4) Pretest - Posttest Assessment  
The tests are the same in accordance with the kinds of questions, number of questions, the questions range features, facilities measured before and after the course.
  - (5) Textbooks: tourism textbook “Hotel basic Japanese”, the first unit (Accommodation Registration), the second unit (Check-out), and the third unit of the tourist hotels idioms etc. The ranges of teaching contents are including that vocabulary and conversation practice.
  - (6) Method: in accordance with the foregoing teaching subjects, were introduced into the e-smart pen (with, without) and network learning situation (with, without), e-situated learning and to Japanese vocabulary and conversation of the treatment group and the control group, respectively, before and after the course ability tests (full score 20 points), measured student learning outcomes, investigate two factors, the main effect of the e-smart pen and internet), as well as different teaching methods affect the learning achievement of students of Japanese.

### III. The experimental results

#### 1. ANCOVA for “e-smart pen” and pre-test Japanese performance

To see if the covariate significantly interacts with the independent variable, run an ANCOVA model including both the independent variable and the interaction term is the standard conduction. If the interaction is significant, ANCOVA should not be performed. Since the p-values of .255(interaction term of “e-smart pen” and pre-test vocabulary) and .267(interaction term of “e-smart pen” and pre-test conversation) are not significant at the level of .05 (Table 3), the assumption of homogeneity of regression slopes is not rejected and the ANCOVA can be performed.

TABLE 3. TEST RESULT OF HOMOGENIETY OF REGRESSION SLOPES FOR  
 “E-SMART PEN”  
 AND PRE-TEST JAPANESE PERFORMANCE

Source	Type III sum of squares	df	Mean Square	Significant	
Dependent variables: post-test_vocabulary R square = 0.184 (adjusted R-square = 0.167)					
pre-test_vocabulary	368.195	1	368.195	10.307	0.002**
e-smart pen	663.598	1	663.598	18.577	0.001**
e-smart pen* pre-test_vocabulary	46.542	1	46.542	1.303	0.255
Error	5393.911	151	35.721		
Total	22611.000	155			
Dependent variables: post-test_conversation R square = 0.274 (adjusted R-squared = 0.260)					
Pre-test_conversation	845.810	1	845.810	30.533	<0.001**
e-smart pen	778.776	1	778.776	28.113	<0.001**
e-smart pen* pre-test_conversation	34.313	1	34.313	1.239	0.267
Error	4182.881	151	27.701		
Total	10186.000	155			

\*: p<0.05, \*\*: p<0.01

The ANCOVA results are summarized in Table 4. Both pre-test vocabulary and conversation reaches significant by its p-values and this indicates that pre-test vocabulary and conversation contributes to the prediction of post-test vocabulary and conversation. It is worth noting that, after excludes the influence of pre-test vocabulary and conversation separately, F-values of 17.254 (p<.001) and 27.143 (p<.001) provide sufficient evidence to conclude that usage of “e-smart pen” would make significant different on the scores of post-test vocabulary and conversation.

TABLE 4. JAPANESE ACHIEVEMENTS ANCOVA SUMMARY TABLE

Source	Type III sum of squares	df	Mean Square	F	Significant
Dependent variables: post-test_vocabular R square = 0.177 (adjusted R-square = 0.166)					
Pre-test_vocabulary	344.014	1	344.014	9.611	0.002**
E-smart pen	617.562	1	617.562	17.254	0.001**
Error	5440.453	152	35.792		
Total	22611.000	155			
Dependent variables: post-test_R square = 0.268 (adjusted R-square = 0.259)					
Pre-test_conversation	814.521	1	814.521	29.358	0.001**
E-smart pen	753.061	1	753.061	27.143	0.001**
Error	4217.194	152	27.745		
Total	10186.000	155			

\*:  $p < 0.05$ , \*\*:  $p < 0.01$

## 2. ANCOVA for internet and pre-test Japanese performance

From Table 5, the interaction between Internet (independent variable) and pre-test conversation (covariate) is not significant at the 5% significant level ( $p=0.397$ ). There is insufficient evidence to infer that the correlation between pre-test conversation and post-test conversation (dependent variable) would be affected by different level of Internet. In other words, the slope of regression equation of post-test conversation on Internet is no difference. Therefore, the analysis of covariance can be proceeded.

TABLE 5. TEST RESULT OF HOMOGENIETY OF REGRESSION SLOPES FOR INTERNET AND PRE-TEST JAPANESE PERFORMANCE

Source	Type III sum of squares	df	Mean Square	F	Significant
Dependent variables: post-test_vocabulary R square = 0.150 (adjusted R-square = 0.133)					
Pre-test_vocabulary	574.968	1	574.968	15.460	0.001**
Internet	394.669	1	394.669	10.612	0.001**



Internet * Pre-test_vocabulary	149.581	1	149.581	4.022	0.047*
Error	5615.704	151	37.190		
Total	22611.000	155			
Dependent variables: post-test_ conversati R square = 0.153 (adjusted R-square on = 0.136)					
Pre-test_conversation	228.599	1	228.599	7.071	0.009**
Internet	79.703	1	79.703	2.465	0.118
Internet*Pre-test_conversation	23.285	1	23.285	0.720	0.397
Error	4881.953	151	32.331		
Total	10186.000	155			

\*: p<0.05, \*\*: p<0.01

To elaborate the influence of internet on conversation capability, the insignificant p-value of .158 in Table 6 tells the truth that whether usage of internet or not doesn't make any difference on conversation test after excluding pre-test conversation and total score.

Table 8 shows the effect of pre-test conversation application (covariate) is significant  $F = 26.556$  ( $P < 0.001$ ), indicated that pre-test conversation application (covariate) on the post-test conversation application (dependent variable) which have a high explanatory power. And exclude the pre-test conversation applications with the influence of the total score, the use of the internet or not there was no significant difference. The internet has failed to effectively enhance students' conversation application capabilities.

TABLE 6. JAPANESE ACHIEVEMENTS ANCOVA SUMMARY TABLE

Source	Type III sum of squares	df	Mean Square	F	Significant
Dependent variables: post-test conversat R squared = 0.149 (adjusted R-square ion = 0.138)					
Pre-test_conversation	857.002	1	857.002	26.556	0.001**
Internet	65.017	1	65.017	2.015	0.158
Error	4905.238	152	32.271		
Total	10186.000	155			

\*: p<0.05, \*\*: p<0.001

#### IV. Conclusion

In this study the experiment 1 attempts to explore the effectiveness of learning into the curriculum of the e-smart pen, and experimental result from the experiment 1 is that:

- (1) The course of the import of e-smart pen will certainly help enhance the learning effect, the students' learning abilities showed positive learning outcomes.
- (2) Whether the high score group or the low score group in the twice of vocabulary and conversation Attainment Tests, the two groups were compared test scores showed a positive effect. When in the experiment, the high score group grades although no statistically significant differences, but the two groups carried out the tests. The vocabulary average score of treatment group is 96.5. The vocabulary average score of control group is 91.73, The results showed the average scores of both groups improved. The high score group treatment group have a conversation average score of 94.17 points, the control group average score 97.36, high scores in both groups, no significant differences in the statistical, possible reasons is: 1). The high score students with strong learning willingness are more likely to take the initiative to learn. 2). They have the ambition to achieve their goals, easily an interest in things around, will take the initiative to gather relevant information relatively their best to achieve the pre-set target. Therefore, regardless of the "e-smart pen" presence or absence of aid could render positive learning outcomes. Relative to the low-scoring group, whether the vocabulary or the conversation statistically reached significant difference in the average scores of the treatment group were significantly greater than the average scores of the control group, proves "e-smart pen learning efficacy in low presents a great role, and the low score group effect greater than the high score group effect represents the integration into the e-smart pen courses teaching methods to achieve the expected goals to improve learning outcomes. Analysis of possible causes: in low score group they general are lack of willingness and their learning are weak, the majority of which type of inspiring learning, the course import e-smart pen timely learning context can induce their motivation to learn.

The results of experiment II shows that 1) the Japanese vocabulary and conversation overall performance can enhance a teaching tool through e-smart pen, e-smart pen instant Tap effective link "stimulus - response" through information processing model to produce language chain reaction, so it can effectively enhance the Japanese Language Proficiency. 2) Internet can enhance the vocabulary ability, but the conversation score cannot achieve a significant difference, whether the possible reasons for the amount of internet time in contact with students, or restrictions of syllable recognition links, or pages interesting, that can be further explored.

Overall, the technology-mediation into teaching, whether it is e-smart pen teaching or internet teaching are to enhance Japanese learning achievement, and regardless of the high score group or the low-scoring group in the test scores of vocabulary and conversation twice showed a positive effect. Although the two groups of high scores statistically is not a significant difference, but the results are positive growth, reached statistical significant difference relative to the low-scoring group vocabulary or conversation, "e-smart pen" learning efficacy in the low-scoring group presents a great effect, the problem of this study are supported.

It's displayed that under the technology-mediation, learners can not only complete the learning activities, but also obtain better learning effects. Particularly, in the "usefulness" of the cognitive aspects of e-smart pen, and internet information systems can strengthen the performance of the Japanese learning achievement.

## V. References

- [1] Yu, Fu-yun (2003) . *Mode with the use of the Internet learning strategies*. March 3, 2007, retrieved from <http://edtech.ntu.edu.tw/epaper/>
- [2] Chang, S. H. (2009a). *The Application of Technology Mediated Learning's Teaching and Strategy on the Junior High School History Subject*. e-CASE 2009 Singapore (January 8-10, 2009).
- [3] Chang, S. H. (2009b, January). *Exploration of Modern Instructional Technology and Reformation from the Perspectives of E-Learning*. Paper presented at the e-CASE 2009 Singapore (January 8-10, 2009).
- [4] McCombs, B. L., and Whisler, J. S. (Eds) (1997). *The learner-centered classroom and school*. San Francisco: Jossey-Bass.
- [5] Tsai, Y.-C. (2006) . *Preliminary Study of digital learning teaching strategies*. March 2, 2007, retrieved from <http://yang.nhlue.edu.tw/tanet2006/N.htm>
- [6] Alavi, M., & Leidner, D. E. (2001). Research Commentary: Technology-mediated Learning – A Call for Greater Depth and Breadth of Research. *Information Systems Research*, 12(1), 1-10.
- [7] Alavi, M., Wheeler, B. C., & Valacich, J. S. (1995). Using IT to Reengineer Business Education: An Exporatory Investigation of Collaborative Tele-learning. *MIS Quarterly*, 19(3), 293-313.
- [8] Alavi, M. (1994). Computer-Mediated Collaborative Learning: An Empirical Evaluation *MIS Quarterly*(18:2), June 1994, 159-174.
- [9] Marki, R. H., Marki, W. S., Patterson, M., & Whittaker, P. D. (2000). Evaluation of a Web-based Introductory Psychology Course: I. Learning and Satisfaction in On-line Versus Lecture Course, *Behavior Research Methods, Instruments and Computers*, 32, 230-239.
- [10] Chen, Y.-P. (2004). *Decision rules dynamically constructed from log files of the learning process of the original adaptive learning*. Thesis, Institute of Information Management, National Sun Yat-sen University, Unpublished, Kaohsiung.
- [11] Zhang, D., Pan, G.-W. and Peng, L. D. (2007) . *Analysis of self-initiative to learn from the evaluation perspective*, Leshan Teachers College Paper, 20(10), 118-121.
- [12] Shih, H. C., Feng, D. P. and Han, C. T. (2010). *Incorporate digital technology to examine the effect of learning Japanese language-by using e-learning pen*. The 2010 International Conference on e-Commerce, e-Administration, e-Society, e-Education, and e-Technology: Macao.

*The Relationship between Analytic and Holistic Styles of Thinking and Forgiveness*

Loan Bui, Sharon Flicker

Asian University for Women, Bangladesh

0500

The Asian Conference on Psychology & the Behavioral Sciences 2013

Official Conference Proceedings 2013

Abstract

This study examined the relationship between styles of thinking (analytic and holistic) and willingness to forgive. Previous research has demonstrated that individuals attend to their worlds in qualitatively different ways: analytic thinkers focus on objects and their attributes while holistic thinkers focus on the context as a whole, in which objects are viewed in relation to each other. Consistent with these differences in attention, analytic thinkers may be more likely to make internal attributions for other people's transgressions while holistic thinkers may tend to perceive external attributions for those transgressions (Nisbett, Peng, Choi, & Norenzayan, 2001). Research has shown that people who attribute transgressions to external factors report higher levels of forgiveness (Fincham, Paleari, & Regalia, 2002). Thus, analytic and holistic styles of thinking may be related to a person's willingness to forgive. We therefore hypothesized that people who think more holistically would be more forgiving because they view others' behaviors as more strongly influenced by situational factors. On the other hand, people who think more analytically would be less likely to forgive because they are more likely to understand others' transgressions as a result of their underlying dispositions. Study participants answered online surveys regarding their styles of thinking (analytic or holistic), their attributional style (situational or dispositional) and their willingness to forgive. Holistic thinkers were found to be more likely to forgive others than analytic thinkers. However, this relationship was not mediated by attributional style. Alternative explanations for the findings are discussed.

Through the transformation of negative emotions to neutral or positive ones, forgiveness is one of the most effective tools to prevent conflicts and to heal relationships after conflicts (McCullough, Root, Tabak, & Witvliet, 2009; Thompson, et al., 2005). It can also heal emotional wounds and foster greater personal well-being after the occurrence of transgressions (DiBlasio & Proctor, 1993; Toussaint & Webb, 2005). Recognizing these potential benefits, an increasing number of clinical intervention programs are focusing on forgiveness. Unfortunately, despite its increasing popularity as a target for clinicians, our knowledge about forgiveness and the factors that may influence it are limited (Gordon, Baucom, & Snyder, 2000; Worthington, 1998). Researchers have only recently begun to explore which factors may be related to individuals' willingness to forgive another's transgression against them (Fincham, 2000). The current study seeks to add to this effort, examining how analytic and holistic styles of thinking may relate to forgiveness.

### **Transgressions and Forgiveness**

According to Thompson et al (2005), an individual may perceive that a transgression has been made against them when an action contradicts their expectations and assumptions about how things should be, often resulting in negative thoughts, feelings and behaviors against the transgressions and the transgressors. People may respond to transgressions in various ways, one of which is forgiveness.

Forgiveness is an emotional and cognitive process (Enright & Fitzgibbons, 2000; Smedes, 1998) in which negative thoughts and feelings towards the transgressions and transgressors are transformed into either neutral or positive ones (Thompson, et al., 2005). Forgiveness is an individual mental process in which individuals may consider various factors such as the transgression's level of harm, the surrounding circumstances, or/and the transgressors' personalities in order to decide whether they want to let go of negative emotions towards the transgressors and forgive them. There may be several targets of the act of forgiveness, such as the self, another person(s), or a situation. In this study, we focus on the tendency to forgive others. We examine the thinking processes of people who perceive transgressions made against them in order to better understand the decision to forgive.

### **Causal Attribution and Forgiveness**

One factor that an individual is likely to consider when deciding whether to forgive a transgression is the cause of that transgression. There are two main types of causal attributions: external (contextual) and internal (personal) (Heider, 1958). People who apply external attributions focus their attention on situational factors, such as the environment, peer pressure, social positions and economic status. On the contrary, people who apply internal attribution consider mainly the personality, intentions or dispositions of the transgressors as the cause for what happened (Weiner, 1995).

It is thought that individuals who make external attributions for behaviors would be less likely to view a transgressor as solely responsible for his/her actions and would thus be more likely to forgive him or her. Consistent with this idea, several researchers have documented the relationship between causal attribution and forgiveness (e.g., Fincham, 2000; Fincham & Bradbury, 1992; Fincham, Paleari, & Regalia, 2002). Fincham and his colleagues (2002) surveyed 79 Italian husbands and 92 wives. They demonstrated that spouses who made external



attributions for their partners' transgressions reported a higher tendency to forgive than spouses who made internal attributions. When the spouse used an 'internal attribution' lens to explain their partner's transgression, they viewed the transgressor as more accountable for the event. In this case, the spouse may find it more difficult to forgive because she or he believed that the transgressor intentionally hurt her or him. Although the causal nature of this relationship is difficult to discern from these correlational findings, it is possible that one's willingness to forgive may be related to the causal attribution one makes for the transgression.

### **Styles of Thinking and Causal Attributions**

Another factor that might relate to forgiveness is the individual's thinking style: analytic or holistic. People who think more analytically focus on objects and their individual attributes while people who think more holistically focus on the context and objects are viewed in relation to each other (Nisbett, Peng, Choi, & Norenzayan, 2001). These two styles of thinking have been proposed to differ in four dimensions: focus of attention, attributions for behaviors, perception of the nature of change, and tolerance of contradictions (Nisbett, et al., 2001). Namely, when observing an object or event, holistic thinkers tend to pay attention to the entire context while analytic thinkers tend to focus on the object as separate from its context (locus of attention). In terms of attributions, holistic thinkers tend to locate the cause of an event in the interactions between the actor and his/her surrounding conditions while analytic thinkers would be more likely to emphasize the internal dispositions of the actor as the cause of an event (causality). Regarding perception of change, holistic thinkers are more likely to expect constant change due to the complex interactions between phenomena while analytic thinkers are more likely to believe that the future is predictable and that phenomena will proceed in similar patterns as they have in the past (Perception of Change; Peng & Nisbett, 1999). For instance, if the value of a stock is decreasing, an analytic thinker will be more likely to believe that the value will continue to decrease over time. Finally, holistic thinkers are more tolerant towards contradictions. They are more likely to accept that two seemingly contradictory propositions could be simultaneously true and even complementary to each other while analytic thinkers are more likely to feel that only one proposition can be true at a time (Attitude Toward Contradictions; Peng & Nisbett, 1999).

Nisbett et al. (2001) suggested that because analytic thinkers focus on individual objects and their attributes, they would be more likely to locate the cause of an event in the disposition of the actor. In contrast, because holistic thinkers tend to focus on the whole picture rather than separate parts, they would be likely to take surrounding factors into consideration in addition to the object. In other words, analytic thinkers might be more likely to make internal or dispositional attributions for others' behaviors while holistic thinker might be more likely to make external or contextual attributions.

### **The Current Study: Thinking Styles and the Tendency to Forgive**

Given that individuals who focus on external attributions for others' behaviors are more likely to forgive than those who make internal attributions; and holistic thinkers may make more external attributions for others' behaviors while analytic thinkers may make more internal attributions, it



follows that holistic thinkers may have a greater willingness to forgive than analytic thinkers. We therefore hypothesize that:

1. Holistic thinkers will be more forgiving of transgressions compared to analytic thinkers.
2. Of the four dimensions of thinking styles (Causality, Attitude Toward Contradictions, Perception of Change, and Locus of Attention), Causality will be most closely related to the tendency to forgive.
3. The relationship between one's thinking style and one's tendency to forgive will be mediated by the type of causal attributions made regarding transgressions. Holistic thinkers will be more forgiving because they make external attributions towards the transgressions, while analytic thinkers will be less forgiving because they make internal attributions.

In the current study, we drew our sample from both Western and Eastern populations. Since research has shown that Westerners tend to think more analytically while Asians tend to think more holistically (Nisbett & Miyamoto, 2005), we hoped the inclusion of individuals from both the East and the West would result in a wide variability in thinking styles. In addition, the inclusion of Asian participants adds to previous findings in the area of forgiveness, which have relied primarily on Western samples.

## Methods

### Participants

Participants were recruited online through postings on the Facebook accounts of the authors and of participants who chose to post the link of the survey on their facebook accounts. Participants were also recruited through a university-wide email sent out to all faculty, staff and students of an international university in Bangladesh. Of 357 participants who began the survey, 200 (56%) completed it. Of these 200, six did not provide demographic information. Those who completed all of the surveys and provided demographic information included 162 women and 32 men, ranging in age from 16 to 80 years ( $M= 32.76$ ,  $SD= 13.2$ ). Participants represented a significant variety of ethnicities: the sample consisted of 40.7% Asian participants (whose birth countries are Bangladesh, Bhutan, Cambodia, India, Malaysia, Myanmar, Nepal, Pakistan, Palestine, Sri Lanka, Syria and Vietnam) and 59.3% Western participants (whose birth countries are Canada, Germany, Spain, Trinidad, U.S and U.K). In terms of occupation, 104 (53.9%) worked outside the home, 10 (5.2%) were retired or worked in the home, and 79 (40.9%) were undergraduate or graduate students.

### Measures

**Willingness to forgive.** We measured participants' self-reported tendency to forgive with the Heartland Forgiveness Scale (HFS, Thompson & Snyder, 2003). The HFS includes a total forgiveness score and is also divided into three six-item subscales, which measure dispositional forgiveness of self, of others, and of situations that are beyond their control, such as disease. Participants were asked to indicate their agreement with 18 statements on a 7-point scale, from 1= Almost Always False of Me to 7= Almost Always True of Me. The scale has been used in numerous studies about forgiveness (e.g., Day, & Maltby, 2005; Edwards et al., 2002; Thompson

et al., 2005) and been shown to be a valid and reliable measure of the tendency to forgive (Thompson & Snyder, 2003). For the current study, we used only the forgiveness of others subscale, for which the alpha was 0.75

**Causal Attributional Style.** We measured participants' understanding of the causes of transgressions against them using the Transgression Attribution Questionnaire (TAQ; Hook, 2007). Participants were first asked to remember and think about a specific transgression against them. We did not specify a particular type of transgression or time period in which the transgression should have occurred. Participants were then asked to rate their current beliefs about the cause of the transgression, indicating their agreement with each of 10 statements on a 5-point rating scale from 1= strongly disagree to 5= strongly agree. The TAQ is divided into two five-item subscales: internal attribution (e.g., "He or she is not a good person") and external attribution (e.g., "He or she has had a rough time lately"). Higher scores on each subscale indicate a greater tendency to make an internal or an external attribution accordingly. For the current sample, the alphas are .85 for the Internal Attribution subscale and .83 for the External Attribution subscale.

**Analytic and Holistic Thinking.** We measured participants' styles of thinking with the Analysis-Holism Scale (AHS; Choi, Koo, & Choi J., 2007). The AHS consists of 24 items in which participants rate statements on a 7-point scale from 1= strongly disagree to 7= strongly agree. In addition to a total score, the AHS is divided into 4 subscales, each consisting of 6 items. The first subscale measures the types of causal attributions people make (e.g., "Any phenomenon has numerous numbers of causes, although some of the causes are not known"). The second subscale measures participants' level of tolerance towards contradiction (e.g., "We should avoid going to extremes"). The perception of change subscale measures the expectations that participants hold toward future events (e.g., "Current situations can change any time"). The locus of attention subscale measures whether participants tend to focus on parts or on the whole (e.g., "It is not possible to understand the parts without considering the whole picture"). Higher scores on the total scale represent a greater tendency to apply holistic thinking. Similarly, higher scores on each of the subscales indicate that participants give more weight to external attributions for behaviors, have more tolerance towards contradiction, believe that the future is unpredictable, and pay more attention to the whole context. The scale has been validated with a sample of Americans and Koreans (Choi, et al., 2007) and has been used in many studies of thinking styles (e.g., Jen, & Lien, 2010, Konrath, Bushman, & Grove, 2009). For the current sample, the Cronbach's alpha coefficients were 0.76 for the total scale, 0.78 for the Causality subscale, 0.74 for the Attitude toward Contradictions subscale, 0.72 for the Perception of Change subscale and 0.65 for the Locus of Attention subscale.

## **Procedure**

Both authors posted an online version of the survey to their Facebook accounts and a university-wide announcement was emailed to all faculty, staff and students requesting their participation. Participants were also requested to post the survey's link in their own Facebook accounts, if they were willing, in order to facilitate snowball sampling. After reading a consent form describing the study procedures and their rights as research participants, participants indicated their consent by pressing a button to enter the survey rather than signing their names, to preserve anonymity. Those who did not consent were directed away from the survey. The survey took about 15 minutes to complete. We provided our contact information and encouraged participants to

contact us to discuss any questions, comments, or concerns regarding the survey. The online survey was active for approximately one month.

## Results

**Sample Characteristics.** Table 1 displays the age, gender and occupations of the total sample, Asian subsample, and North American/European subsample. Significant differences exist between the Asian and Western subsamples in age,  $t(133.509) = -13.468, p < .001$ , gender,  $\chi^2(2) = 19.282, p < .001$ , and occupation,  $\chi^2(4)=98.672, p < .001$ . Compared to the Asian subsample, the Western subsample was significantly older, included more male participants, and was more likely to be employed or in other occupations (e.g., retired, non-income generating work).

Table 1 also displays the means and standard deviations of all the measures used in the study. There are no significant differences between the Asian or the North American/European subsamples on any of the measures.

**Hypothesis 1.** Our first hypothesis was that participants who apply holistic thinking would be more forgiving of others compared to people who apply analytic thinking. Both the thinking style and the forgiveness of others variables are continuous, so this hypothesis was tested through a Pearson's correlation. This hypothesis was supported by the data,  $r(200) = 0.20, p < .001$ .

**Hypothesis 2.** Our second hypothesis was that, of the four aspects of Analysis/Holism (Causality, Attitude toward Contradictions, Perception of Change and Locus of Attention), Causality would be most closely related to the Forgiveness of Others. The correlation of each of the Analysis/Holism Subscales with Forgiveness of Others is as follows: Causality,  $r(200) = 0.24, p = .001$ , Attitude toward Contradictions,  $r(200) = .12, ns$ , Perception of Change,  $r(200) = 0.01, ns$ , and Locus of Attention,  $r(200) = 0.10, ns$ . Thus, this hypothesis was also supported by the data.

**Hypothesis 3.** Our third hypothesis was that the relationship between thinking style and tendency to forgive would be mediated by the types of causal attribution made about transgressions. We thought participants who thought more holistically would make more external attributions for transgressions and be more forgiving of transgressors while participants who thought more analytically would make more internal attributions for transgressions and be less forgiving of transgressors. We did two sets of analyses, testing both Internal Attribution and the External Attribution as mediators.

The standard procedure for testing the mediation hypothesis, as described by Baron and Kenny (1986), involves determining that relationships exist between 1) the initial variable (Analytic/Holistic Thinking) and the criterion variable (Forgiveness of Others), 2) the initial variable (Analytic/Holistic Thinking) and the potential mediating variable (Internal Attribution and External Attribution), and 3) the potential mediating variable (Internal Attribution and External Attribution) and the criterion variable (Forgiveness of Others).

As hypothesized, Analytic/Holistic thinking was correlated with Forgiveness of Others,  $r(200) = 0.20, p < .001$  and Internal Attribution was correlated with Forgiveness of Others,  $r(232) = -0.30, p < .001$ . External Attribution was also correlated with Forgiveness of Others,  $r(232) = 0.14, p$

< .05. However, contrary to our hypothesis, Thinking Style was not significantly correlated with Internal Attributions or with External Attribution. Thus, mediating hypothesis was not supported.

## **Discussion**

The results support our primary hypothesis that holistic thinking is positively correlated with a higher tendency to forgive others. Specifically, individuals who tend to locate the cause of a behavior in the interactions between the actor and his/her surroundings are more likely to forgive a transgressor than individuals who focus on the internal disposition of the actor as the cause of behavior. Consistent with this idea and with previous findings (e.g., Fincham, 2000; Fincham, et al., 2002; Fincham & Bradbury, 1992), attributional style was also related to the forgiveness of others: participants who tended to make more external attributions for others' transgressions were more likely to forgive and those who tended to make more international attributions less likely to forgive. However, contrary to our third hypothesis, the relationship between thinking style and forgiveness was not mediated by attributional styles.

There are several possible explanations why, although a relationship between thinking style and willingness to forgive was found to exist, the relationship was not mediated by attributional style. Firstly, the relationship may be mediated by another variable, rather than by attributional style. For instance, individuals who tend toward holistic ways of thinking may also be more collectivistic than analytic thinkers (Nisbett & Miyamoto, 2005; Nisbett, et al., 2001). People who are more collectivistic tend to identify themselves with a group, value the group' goals as more important than their own, and are thus motivated by the group' goals rather than individual ones. In contrast, people who are more individualistic value their individual needs and preferences over the groups' needs, think of themselves as independent from other members of society, and are motivated by their own individual goals (Hook, Worthington, Utsey, Davis, & Burnette, 2012). Collectivists value interpersonal harmony (Sandage & Wiens, 2001) and stress the importance of reconciliation and relationship repair. Consequently, people from collectivist societies are likely to experience significant social pressure to preserve social harmony and happiness (Ho & Fung, 2011) and thus may view forgiveness as a duty (Hook et al., 2012). This social pressure may override individual views about the cause of the transgression and result in a greater tendency to forgive others. Alternatively, given the pressure to maintain social harmony, a transgressor in a collectivistic society may be more likely to apologize and make amends for the transgression than a transgressor in an individualistic society. Accordingly, a positive correlation has been found between collectivistic self-construal and forgiveness (Hook et al., 2012). Thus, the correlation between styles of thinking and forgiveness identified in the current study may be a statistical artifact, with styles of thinking serving as a proxy for the individuals' level of collectivism/individualism.

Alternatively, differences in analytic and holistic thinkers' tendency to experience empathy, which requires the ability to sense how another might be feeling, may mediate the relationship between styles of thinking and forgiveness. Holistic individuals tend to have more interdependent senses of selves, or senses of selves that overlap with close others, compared to analytic thinkers, whose senses of self tend to be more bounded (Nisbett et al., 2001). Because individuals with interdependent self-construals incorporate close others into their identities, they may be more empathetic. Thus, regardless of the causal attribution that they make to explain the



transgression, in comparison to analytic thinkers, holistic individuals may feel empathetic to the transgressors, leading to greater forgiveness.

An individual's predisposition to experience socially engaged or disengaged emotions is another potential mediator of the relationship between styles of thinking and forgiveness. Socially engaged emotions, such as respect, friendliness, and guilt, facilitate interpersonal relationships, while socially disengaged emotions, such as pride, superiority and anger, tend to separate people from others, (Kitayama, Markus, & Matsumoto, 1995). Socially engaged/disengaged emotions have been found to be correlated to independent and interdependent self-construal (Matsumoto, 1990), such that those with independent self-construals are more likely to experience socially disengaged emotions and those with interdependent self-construals are more likely to experience socially engaged emotions. Individuals with interdependent senses of selves are more tolerant and accepting of others (Schwartz, 1992) and may thus experience socially engaged emotions even after perceiving a transgression against them (Schwartz, 1992), emotions that would lead to a more forgiving response. On the contrary, people with independent senses of selves would be more likely to experience socially disengaged emotions following a transgression (Schwartz, 1992), leading to a tendency to be less forgiving. In previous studies, individuals primed to think either independently or interdependently have been shown to demonstrate analytic or holistic thinking, respectively (e.g. Kim & Markman, 2006; Kühnen & Oyserman, 2002). It follows that analytic thinkers may be more likely to experience socially disengaged emotions and be less forgiving compared to holistic thinkers who may experience socially engaged emotions and therefore be more forgiving.

Before ruling out attributional style as a mediator of the relationship between styles of thinking and forgiveness, it is important to consider the limitations of our methodology that may have prevented us from identifying a true relationship. For instance, the measures we chose to assess thinking styles and forgiveness were both dispositional or trait-like in nature while the participant's attributional style was assessed in relation to a specific participant-selected transgression and thus measured the participant's state attributional style rather than his or her trait attributional style. Traits are stable attributes while states are temporary characteristics that are influenced by different situations and internal motives at these particular times. Participants' responses to the measure of attributional style may thus have been specific to the particular transgression they selected. A measure of a temporary state may not have been the best choice of mediator of the relationship between two trait measures. Given that the causality subscale of the Analysis-Holism scale, which is essentially a measure of attributional style, seems to be driving the correlation between thinking style and forgiveness, it will be worthwhile to reexamine attributional style as a mediator of this relationship with a dispositional measure of attributional style.

### **Strengths and Limitations**

This sample is notable for its diverse sample, in terms of age, cultural background, and occupation of the participants. This sample is distinctive in that it includes Southeast Asians and South Asians, when most studies of thinking styles have examined East Asians or Westerners. We believe the inclusion of individuals from North America, Europe and Asia resulted in greater variability in thinking styles than if we had recruited our sample from a single culture. It furthermore allowed us to have greater confidence in the generalizability of the findings. However, several limitations of our study should also be noted.

Firstly, women were significantly overrepresented in our sample (83.5%). As a result, our findings might not generalize to men. Secondly, our survey was in English; however, nearly half of our participants are from Asia and their first languages are probably not English. Therefore, language difficulties may have prevented some participants from accurately understanding the questions. The third limitation is that the study was conducted online as a self-reported survey. Because we were not present while participants completed the surveys, we were not available to assist in case of language difficulties nor could we ensure that participants devoted their full attention to the survey. However, it should be noted that several other investigations of forgiveness have also utilized an online format (e.g., Hook et al., 2012.).

Fourthly, although our measure of willingness to forgive, the Heartland Forgiveness Scale, demonstrated adequate reliability and validity in a sample recruited from a Midwest American university (Thompson & Snyder, 2003; Thompson et al., 2005) and has been used previously with Asian samples (e.g., Pareek & Jain, 2012), the measure has not yet been validated with Asian populations. Similarly, the measure we used to assess attributional style, the Transgression Attribution Questionnaire, has not undergone full peer-review, and requires further testing before we can be confident of its reliability and validity (Hook, 2007).

In addition, the transgressions that individual participants recalled prior to answering the questions related to attributional style may have varied greatly in terms of the nature and severity of the transgression as well as the relationship to the person who transgressed. One can imagine that the process of forgiveness would differ for mild versus severe transgressions or for transgressions committed by friends versus life partners. While this method has positive implications for the generalizability of the findings, it is also possible that combining such diverse sorts of transgressions could have “muddied the waters,” obscuring the identification of relationships between variables that may have emerged had we specified a certain type of transgression. Furthermore, as in any study that examines recall of past events, participants’ memories about prior transgressions may be less than accurate. Likewise, studies that utilize self-report are prone to desirability and other response biases.

Finally, individuals with independent self-construals tend to experience more stable senses of selves while those with interdependent self-construals tend to change their sense of self with context (Kanagawa, Cross, & Markus, 2001). Therefore, measuring the dispositional traits of thinking styles and of forgiveness may have been less valid for participants from interdependent cultural contexts (such as many cultures in Asia) since they might not have consistent styles of thinking or a stable tendency of forgiveness. In other words, Asian participants’ thinking styles and willingness to forgive may vary based on the context more than those of the participants from independent cultural contexts.

### **Directions for Future Research**

In light of the noted limitations, replication of this study with a more balanced gender representation among participants would be a useful endeavor. It would also be worthwhile to re-examine causal attribution as a mediator of the relationship between thinking styles and forgiveness in a future study, either using a dispositional or trait measure of causal attributions or using state measures of thinking styles and of forgiveness. Future research in this area would also benefit from the use of measures translated to participants’ dominant language and validated in the cultures from which the participants are drawn.



In summary, although replication is necessary, our findings suggest a link between styles of thinking and willingness to forgive. However, the hows and whys of that relationship have yet to be discovered. The next step in our research program will be to experimentally manipulate participants' thinking styles in order to investigate whether the nature of the relationship between thinking styles and forgiveness is a causal one. We also plan to measure other potential mediators and explanations of this relationship, such as collectivism/individualism, motivations for forgiveness (e.g., interpersonal harmony versus improvement of personal mood), empathy, and socially engaged versus disengaged emotions. Efforts to obtain a better understanding of the factors most closely related to the willingness to forgive, if fruitful, stand to make important contributions towards the development of programs targeting the prevention and resolution of conflict as well as the restoration of personal well-being following perceived transgressions.

The logo for the International Association for Forensic Psychology (iafor) is centered on the page. It consists of the lowercase letters "iafor" in a light blue, sans-serif font. The text is enclosed within a circular graphic composed of two overlapping, thick, brush-stroke-like lines. The outer line is a light blue color, and the inner line is a light pink color. The lines are not perfectly circular, giving the logo a hand-drawn, artistic feel.

iafor

## References

- Baron, R. M., & Kenny, D. A. (1986). The moderator-mediator variable distinction in social psychological research: Conceptual, strategic, and statistical considerations. *Journal of personality and social psychology*, *51*(6), 1173-1182. doi: 0022-3514/86
- Choi, I., Koo, M., & Choi, J. A. (2007). Individual differences in analytic versus holistic thinking. *Personality and Social Psychology Bulletin*, *33*(5), 691-705. doi: 10.1177/0146167206298568
- Day, L., & Maltby, J. (2005). Forgiveness and social loneliness. *The Journal of Psychology*, *139*(6), 553-555. doi: 10.3200/JRLP.139.6.553
- DiBlasio, F. A., & Proctor, J. H. (1993). Therapists and the clinical use of forgiveness. *American Journal of Family Therapy*, *21*(2), 175-184. doi: 10.1080/01926189308250915
- Edwards, L. M., Lapp-Rincker, R. H., Magyar-Moe, J. L., Rehfeldt, J. D., Ryder, J. A., Brown, J. C., & Lopez, S. J. (2002). A positive relationship between religious faith and forgiveness: Faith in the absence of data? *Pastoral Psychology*, *50*(3), 147-152. doi: 10.1023/A:1012940402668
- Enright, R. D., & Fitzgibbons, R. P. (2000). *Helping clients forgive: An empirical guide for resolving anger and restoring hope*. Washington, DC: American Psychological Association.
- Fincham, F. D. (2000). The kiss of the porcupines: From attributing responsibility to forgiving. *Personal Relationships*, *7*(1), 1-23. doi: 1350-4126/00
- Fincham, F. D., & Bradbury, T. N. (1992). Assessing attributions in marriage: The relationship attribution measure. *Journal of Personality and Social Psychology*, *62*(3), 457-468. doi: 0022-3514/92
- Fincham, F. D., Paleari, F., & Regalia, C. (2002). Forgiveness in marriage: The role of relationship quality, attributions, and empathy. *Personal Relationships*, *9*(1), 27-37. doi: 1350-4126/02
- Gordon, K. C., Baucom, D. H., & Snyder, D. K. (2000). The use of forgiveness in marital therapy. In M. E. Mc Cullough, K. Pargament, & C. Thoreson (Eds.), *Forgiveness: Theory, research, and practice* (pp. 203-227). New York: Guilford Press.
- Heider, F. (1958). *The psychology of interpersonal relations*. New York, NY: Wiley.
- Ho, M. Y., & Fung, H. H. (2011). A dynamic process model of forgiveness: A cross-cultural perspective. *Review of General Psychology*, *15*(1), 77. doi: 10.1037/a0022605
- Hook, J. N. (2007). Forgiveness, Individualism, and Collectivism. Unpublished master's thesis, Virginia Commonwealth University, Richmond.

- Hook, J. N., Worthington Jr, E. L., Utsey, S. O., Davis, D. E., & Burnette, J. L. (2012). Collectivistic Self-Constraint and Forgiveness. *Counseling and Values, 57*(1), 109-124. doi: 10.1002/j.2161-007X.2012.00012.x
- Jen, C. H., & Lien, Y. W. (2010). What is the source of cultural differences?--Examining the influence of thinking style on the attribution process. *Acta psychologica, 133*(2), 154-162. doi: 10.1016/j.actpsy.2009.10.011
- Kanagawa, C., Cross, S. E., & Markus, H. R. (2001). "Who am I?" The cultural psychology of the conceptual self. *Personality and Social Psychology Bulletin, 27*(1), 90-103. doi: 10.1177/0146167201271008
- Kim, K., & Markman, A. B. (2006). Differences in fear of isolation as an explanation of cultural differences: Evidence from memory and reasoning. *Journal of Experimental Social Psychology, 42*(3), 350-364. doi: 10.1016/j.jesp.2005.06.005
- Kitayama, S., Markus, H. R., & Matsumoto, H. (1995). Culture, self, and emotion: A cultural perspective on "self-conscious" emotions. In J.P. Tangney & K.W. Fisher (Eds.), *Shame, guilt, embarrassment, and pride: Empirical studies of self-conscious emotions*. New York, NY: Guilford Press.
- Konrath, S., Bushman, B. J., & Grove, T. (2009). Seeing My World in a Million Little Pieces: Narcissism, Self-Constraint, and Cognitive-Perceptual Style. *Journal of Personality, 77*(4), 1197-1228. doi: 10.1111/j.1467-6494.2009.00579.x
- Kühnen, U., & Oyserman, D. (2002). Thinking about the self influences thinking in general: Cognitive consequences of salient self-concept. *Journal of Experimental Social Psychology, 38*(5), 492-499. doi: 0022-1031/02
- Matsumoto, D. (1990). Cultural similarities and differences in display rules. *Motivation and Emotion, 14*, 195-214. doi: 10.1007/BF00995569
- McCullough, M. E., Root, L. M., Tabak, B., & Witvliet, C. V. O. (2009). Forgiveness, In S. J. Lopez (Eds.), *Handbook of positive psychology* (2<sup>nd</sup> ed.; pp. 427-435). New York, NY: Oxford.
- Nisbett, R. E., & Miyamoto, Y. (2005). The influence of culture: holistic versus analytic perception. *Trends in cognitive sciences, 9*(10), 467-473. doi: 10.1016/j.tics.2005.08.004
- Nisbett, R. E., Peng, K., Choi, I., & Norenzayan, A. (2001). Culture and systems of thought: holistic versus analytic cognition. *Psychological Review, 108*(2), 291. doi: 10.1037//0033-295X.108.2.291
- Pareek, S., & Jain, M. (2012). Subjective Well-Being in Relation to Altruism and Forgiveness Among School Going Adolescents. *International Journal of Psychology and Behavioral Sciences, 2*(5), 138-141. doi: 10.5923/j.ijpbs.201220205.02

- Peng, K., & Nisbett, R. E. (1999). Culture, dialectics, and reasoning about contradiction. *American Psychologist*, 54, 741-754. doi: 0003-066X/99
- Sandage, S. J., & Wiens, T. W. (2001). Contextualizing models of humility and forgiveness: A reply to Gassin. *Journal of Psychology and Theology*, 29, 201-211. Retrieved from <http://psycnet.apa.org/psycinfo/2002-06451-002>
- Schwartz, S. H. (1992). Universals in the content and structure of values: Theoretical advances and empirical tests in 20 countries. *Advances in experimental social psychology*, 25(1), 1-65.
- Smedes, L. B. (1998). Stations on the journey from forgiveness to hope. In Worthington, E. L. (Ed.), *Dimensions of forgiveness: Psychological research & theological perspectives* (Vol. 1)(pp. 341-354). Templeton Foundation Pr.
- Thompson, L. Y., Snyder, C. R. (2003). Measuring forgiveness. In S. J. Lopez & C. R. Snyder (Eds), *Positive psychological assessment: A handbook of models and measures* (pp. 301-312). Washington, DC: American Psychological Association.
- Thompson, L. Y., Snyder, C. R., Hoffman, L., Michael, S. T., Rasmussen, H. N., Billings, L. S., ... & Roberts, D. E. (2005). Dispositional forgiveness of self, others, and situations. *Journal of Personality*, 73(2), 313-360. doi: 10.1111/j.1467-6494.2005.00311.x
- Toussaint, L., & Webb, J. R. (2005). Theoretical and empirical connections between forgiveness, mental health, and well-being. In E. L. Worthington Jr. (Ed.), *Handbook of forgiveness* (pp. 349-362). New York, NY: Brunner-Routledge.
- Weiner, B. (1995). *Judgment of responsibility*. New York, NY: Guilford Press.
- Worthington, E. L. (1998). An empathy-humility-commitment model of forgiveness applied within family dyads. *Journal of Family Therapy*. doi: 10.1111/1467-6467.00068

Table 1

*Participant Characteristics*

Demographic	Total Sample <i>n</i> = 194	Asians <i>n</i> = 79	North Americans & Europeans <i>n</i> = 115
Gender			
Female <i>n</i> (%)	162 (83.5 %)	76 (96 %)	89 (77 %)
Male <i>n</i> (%)	32 (16.5 %)	3 (3 %)	26 (23 %)
Occupation			
Employed <i>n</i> (%)	104 (53.9%)	12 (15.2 %)	84 (73.3 %)
Student <i>n</i> (%)	79 (40.9%)	66 (83.5 %)	13 (11.3 %)
Other <i>n</i> (%)	10 (5.2%)		
Age in years <i>M</i> ( <i>SD</i> )	32.76 (13.2)	22.3 (3.87)	40.0 (12.9)
Forgiveness of Others (HFS) <i>M</i> ( <i>SD</i> )	28.29 (6.01)	28.05 (5.31)	28.85 (6.07)
Internal Attribution (TAQ) <i>M</i> ( <i>SD</i> )	13.97 (4.40)	13.73 (4.43)	13.86 (4.50)
External Attribution (TAQ) <i>M</i> ( <i>SD</i> )	15.32 (4.12)	15.47 (4.03)	15.36 (4.33)
AHS Total <i>M</i> ( <i>SD</i> )	115.73 (12.73)	117.15 (12.76)	115.34 (12.43)
AHS Causality <i>M</i> ( <i>SD</i> )	30.19 (5.75)	31.13 (5.09)	29.89 (6.19)
AHS Attitude toward Contradictions <i>M</i> ( <i>SD</i> )	28.14 (5.49)	28.85 (5.06)	27.82 (5.51)
AHS Perception of Change <i>M</i> ( <i>SD</i> )	30.39 (5.21)	29.91 (5.09)	30.78 (5.35)
AHS Locus of Attention <i>M</i> ( <i>SD</i> )	27.03 (4.82)	27.27 (4.54)	26.85 (5.12)

*Note.* Differences between the Asian and North American/European subsamples in age, gender, and occupation are significant at  $p < .001$ . No other differences are statistically significant.

*Development of Resilience Quotient (RQ) Support Activities Set for Disabled Students*

Ammaret Netasit

Lampang Rajabhat University, Thailand

0508

The Asian Conference on Psychology & the Behavioral Sciences 2013

Official Conference Proceedings 2013

Abstract

This research had the objectives to develop a Resilience Quotient Support Activities Set for disabled students, to use the developed Resilience Quotient Support Activities Set to support the resilience quotient for disabled students at the Disability Support Services Center (DSS), Lampang Rajabhat University (LPRU) and to assess the results of the resilience quotient support after using the activities set. The population used in this research was 6 academicians in psychology with resilience quotient experiences, 27 disabled students from DSS, LPRU, 10 distinguished persons specialized in resilience quotient and support activities for disabled students. The research tools were a document analysis form, an interview form, a focus group discussion and a resilience quotient evaluation form from the Mental Health Department, Ministry of Public Health. The statistics used in the analysis of data was the percentage.

The results of the research were one resilience quotient support activities set for disabled students called “Refilling Power, Creating Immunity” consisting of four smaller activities: “Mold then Change” activity, “Open Box, Open Heart” activity, “Tree of the Future” activity and “Tell and Draw” activity and after using the developed activities set to support the resilience quotient in the disabled students at DSS, LPRU, it was found that the students had increased their resilience quotient after the activities as follows: the emotional stability side increased 12.41 %, the mental power side increased 14.43%, the problem management side increased 19.94% and the overall score increased 14.71%.

**Keywords:** Resilience Quotient, Disabled Student



## Background

From the disabled persons statistics in Thailand, from the Disabled Persons Central Registry Database, Office of National Disabled Persons Life Quality Support (2012), from 1 November 1994 to 30 June 2012, there were 1,231,221 disabled persons in the country: 293,168 persons in the North, 141,692 persons in the South, 488,146 persons in the North-east and 265,038 persons in the Central and the East. It can be seen that there are many disabled persons and the trend is increasing all the time such as from diseases and sicknesses, accidents, infection before, during and after child delivery, including from unrest situations whether in childhood needing sufficient and appropriate care and education, adolescence and working age and most of the increased disabled persons were in the working aged population. This makes us lose a lot of social resources that are important forces for the development of the country. Most importantly, when these people become disabled from whatever reasons, their livings are limited by mental conditions, disability conditions, social environment, attitudes that are important factors that make their living in the society less happy than before with the terrible mental conditions, unacceptability for their disabilities especially the period that they become disabled, their mental conditions disappear along with their disabilities. They become discouraged and their confidence in continuous living ends with their disabilities (Phayathai Independent Living for Disabled Persons Center, 2012).

Disabled person problem is not only a personal problem or only looking at some disabled body parts that cannot work normally. Disabled person problem also affects the disabled persons emotionally and mentally. They have anxiety, depression, lack of self-confidence, do not accept their disabilities affecting the treatments and recoveries of their abilities including the continuous effects on their inabilities to enter the educational system, occupation and earning incomes to care for themselves and their families because of their bodily disabilities. We have to look at the effects to the families, family members, relationships to family members, structure and activities in the families, broken families, deteriorating family economic conditions because of reduced or lacked of incomes. Importantly it affects the society and country. The state loses budgets to care for the disabled persons including the loss of human resources that are important for the development of the country and it also becomes a barrier for the development of the country.

Now Lampang Rajabhat University (LPRU) has Disability Support Services (DSS) for disabled students studying at the tertiary level. It is to help students access the teaching and learning systems equally like ordinary students to reduce barriers limiting opportunities of disabled students in the study and help them succeed in the education, participate in the society, improve the disabled students life quality so they have knowledge and ability. The services provided to the disabled students consider from specific disabilities, student needs, reasonability and based on the rights and duties of concerned persons according to the constitution of the Kingdom of Thailand A.D. 2007, the National Education Act A.D. 1999, Revised (2<sup>nd</sup> Act) A.D. 2002 and the Education for Disabled Person Act A.D. 2008 that announces that if the disabled persons want to study, they must be able to do so.

Apart from the mission for having services supporting the disabled students above, the support and recovery of the minds of the disabled persons are very necessary: how

to make them accept their disabilities confronting them, to have no inferior feeling and have morale to develop their own potentials to go on living with dignity and value in their own selves. The research team thought there was a need to study concerning the development of an activity set to develop RQ and used that set to support the RQ of the students in the DSS of LPRU so they could adjust and recover after confronting with problems and help them go through the problems and continue living happily, having positive outlook to the problems and mental immunity when facing new problems and barriers. Moreover the activity set could be a way that other DSSs apply for their students too.

### **Objectives**

1. To develop RQ Support Activities Set (RQSAS) for disabled students at DSS, LPRU.
2. To use the developed RQSAS with the disabled students at DSS, LPRU.
3. To assess the operations of RQ for disabled students at DSS, LPRU.

### **Samples or respondents in this research**

1. Psychological academicians with RQ experience using Purposive Sampling method totaled 6 persons with the duty to provide information about RQ activities.
2. Disabled students at DSS, LPRU, studying during the 2012 academic year totaled 27 persons: divided into 10 students with visual disability, 8 students with hearing disability and 9 students with physical or health disability by collecting data from the whole population.
3. RQ experts and disabled student activities experts totaled 10 persons selected using purposive sampling method with the duties to verify and confirm RQSAS.

### **Research Tools**

The tools used in the data collection were constructed by the research team from related theories and researches, adapted and developed appropriate for this research with the following details:

1. Document Analysis Form using Content Analysis Techniques of Krippendorff (1980) from RQSAS analysis, document search, websites and interviews.
2. Interview Form for interviewing psychological academicians with RQ to collect data concerning RQSAS.
3. Focus Group Discussion of experts so the RQSAS could be used effectively.
4. Unstructured Observation Form for observing disabled students behavior during the activities.
5. Mental Health Evaluation Test (MHET) of the Mental Health Department, Ministry of Public Health to evaluate the presence of RQ in the disabled students before and after using the developed the RQSAS.

### **Research Operations**

Research methodology was divided in the following steps:

1. Studied related documents, research findings and information including ideas, theories and principle of RQ. The studies of the information brought about clearer guidelines and principle of RQSAS.
2. Analyze RQSAS by studying documents, websites and interviews of the 6 psychological academicians with RQ experiences to gain guidelines for developing RQSAS for disabled students at DSS, LPRU.
3. Developed RQSAS by the researcher drafted the RQSAS from the results of related data analysis including the interviews and developed suitable RQSAS.
4. Presented the RQSAS in the Focus Group Discussion of 10 experts with RQ and conducting activities for disabled students to receive possible suggestions when using it.
5. Improved the RQSAS for disabled students using the suggestions from the focus group discussion to develop and improve to have an appropriate RQSAS for disabled students of DSS, LPRU.
6. Tested the developed RQSAS with disabled students who were not the sample group during Children's Day activities at the Center for Skills Development for the Blind, Lampang province to see the possibility for using the RQSAS and studied the possibility of RQSAS application.
7. Use the RQSAS with the population of 27 disabled students at DSS, LPRU after assessing their mental health using the MHET.
8. Assessed the disabled students again after using RQSAS including the observations of their behaviors during their using RQSAS.
9. Concluding and comparing the scores of before and after using the developed RQSAS.

## **Research Findings**

The findings from the research titled "Development of Resilience Quotient (RQ) Support Activities Set for Disabled Students" were as detailed:

### **1. Results of RQSAS development for Disabled Students, DSS, LPRU.**

From the analysis of documents, websites and interviews of RQ experts and RQ psychological academicians, it was found that suitable activities for each category of disabled students had some parts similar and could conduct the RQSAS with different categories of disabled students together so the developed activities set could be used with students with visual disability, hearing disability and physical disability including normal students to create correct understanding between disabled and normal persons and to also encourage friendship to students.

The mentioned activities set had passed the verification and confirmation as RQSAS from the focus group discussion of RQ experts and experts with conducting activities with disabled students experiences and the researcher had improved the activities set according to the consensus of the experts so the set could be of actual use. The set had also passed the experimental use with disabled persons before using it at DSS, LPRU so it became suitable and practical. The components of the set consisted of Acknowledgement, Introduction, Roles of Resource Persons and Assistant Resource Persons in the activities and samples of RQSAS scheme.

Manual of this activities set is called "**Refilling Power, Creating Immunity**" consisted of 4 sub-activities each with instructions, objectives, equipment, important

matters, methods to do the activity, knowledge sheet/conclusion guidelines for resource persons with the following details:

**1<sup>st</sup> Activity title “Mold then Change”** emphasizing the students know their own emotions, accepting their own emotions leading to controlling their emotions, adjusting their emotion, adjusting their thinking and later adjusting their actions.

Methods for conducting the activity	Subject matter/ Media/Equipment
1. Resource person led by saying when students encountered big problems or barriers in their lives, how would the students have the emotions then showed off by molding dough to be symbols communicating their own emotions such as anger might be shown as a chili. Examples of emotions felt by students could be anxiety, sadness, upset, frustration, disappointment, misfortune, anger, depression or continuous happiness and smile. 10 minutes for molding.	1. Dough or velvet wire
2. Resource person had 5 volunteer students (depending on the number of students participating in the activity) explain their emotions from the molded symbols to friends including the advantage and disadvantage sides of the emotions. In case of the disadvantages, students considered the causes of that emotion to understand themselves. Not longer than 5 minutes per student.	1. Symbols of emotions molded from dough or bended from velvet wire.
3. The resource person had students mold emotional symbols for their positive emotions including the method for managing their negative emotions or adjusting their thinking and adjusting their actions and had each student present one of his or her own method that was not the same with the other students.	1. Knowledge sheet/Guideline for conclusion for the resource person
4. The resource person conclude from the presentation of each student how to manage inappropriate emotions, how to adjust the emotions, adjust their thinking and adjust their action including the over-all picture.	1. Knowledge sheet/guideline for conclusion for the resource person

**2<sup>nd</sup> Activity titled “Open Box, Open Heart”** emphasizing building good attitudes toward themselves for the students and adding faith so they have stronger minds.

Methods for Conducting the Activity	Subject matter/ Media/Equipment
1. Resource person opens a video clip of a person with one category of disability and now successful in life and accepted by general public for students to view <b>or</b> invite a person with one	1. A video clip relating past experience, problems encountered, ways to solve them and

type of disability and successful in life and accepted by general public to tell “Past Experience and Road to Success” about 20 minutes.	road to success or a living sample of successful disabled person.
2. In case of a living person, resource person asks students to ask questions in the interested issues.	1. Example person answers questions (Approx. 10 minutes)
3. Resource person have students open their hearts to write their own experiences concerning the problems and barriers in their living in heart-shaped papers without writing their names and put them in a box.	1. Heart-shaped colored papers 2. A heart-shaped box labeled “Open Heart Box”
4. Resource person picks up each heart-shaped paper and read the problems to the students and invites the students to offer ways to solve the problems.	1. Heart-shaped papers written by students about their problems encountered in their lives.
5. Students help conclude problems and barriers encountered and ways to solve them similarly.	1. Assistant resource person conclude as a mind-map.
6. Resource person concludes the over-all picture.	1. Knowledge sheet/guidelines for conclusion for the resource person

**3<sup>rd</sup> Activity titled “Tree of the Future”** emphasizing target setting leading to future success.

<b>Methods for Conducting the Activity</b>	<b>Subject Matter/ Media/Equipment</b>
1. Resource person divides students into groups of three with different categories of disabilities as group members and has each student tell his or her preferable future picture by having each one draw the future picture such as a nurse if she or he wants to be a nurse. (In case of student cannot draw, a group member help to draw the picture)	1. Paper 2. Pencil 3. Eraser 4. Wood color or crayon
2. Resource person asks students to send a group representative to put the pictures of each person on the future tree prepared by the resource person. Compare the target as the fruit of the tree and the other parts such as the stem and other parts of the tree that help the tree to grow as the students themselves. Before they become successful, they need to grow from the stem and develop step by step and has students choose where they are in the tree parts corresponding to their targets such as root, stem, branch, leaves or fruit and attach that student’s picture at that part.	1. Future picture drawn by students. 2. A picture of future tree. 3. Doubled-sided glued tape
3. Students participate in presenting ideas on how to	



be like the set future pictures. (As the fruit of the tree). The ideas of everyone in the groups become the over-all picture of the group.	
4. Group members discuss the case of problems arising and preventing the reaching of future pictures and presenting the flexibility of methods or target adjustment.	
5. A represent of each group comes out to present similar method flexibility or target adjustments concluded from members of the group.	
6. Resource person concludes from group presentation and presents the over-all picture.	1. Knowledge sheet/Guidelines for conclusion for the resource person

**4<sup>th</sup> Activity titled “Tell and Draw”** emphasizing students befriending with each others and helping others as much as possible.

<b>Methods for Conducting the Activity</b>	<b>Subject matter/ Media/Equipment</b>
1. Resource person divides into groups of 3 students with different categories of disabilities. (In case the number of students cannot be divided as needed or some students cannot perform the specified activity, the number of students can be more than three so students can help finish the activity also depending upon the degree of students disability)	
2. Students in the groups sit in column.  1 <sup>st</sup> person must be able to see and tell or transmit to the 2 <sup>nd</sup> person in the format of acting or holding the hands of the 2 <sup>nd</sup> person to act as he wants to communicate (student with hearing disability).  2 <sup>nd</sup> person must be able to transmit to the 3 <sup>rd</sup> person in the format of acting or relating (student with visual disability).  3 <sup>rd</sup> person must be able to draw (a student with physical disability).	
3. Resource person has each group member do as assigned as follows:  1 <sup>st</sup> person look at a prepared picture (each group has a different picture) then relate what he sees to the 2 <sup>nd</sup> person  2 <sup>nd</sup> person receives the information from the 1 <sup>st</sup> person then relate to the 3 <sup>rd</sup> person	1. Pictures must not be too difficult to draw such as animals, fruits or objects used in home 2. Paper 3. Pencil 4. Eraser



<p>3<sup>rd</sup> person draws the picture as told by the 2<sup>nd</sup> person and the 2<sup>nd</sup> person can ask the details of the picture from the 1<sup>st</sup> person all the time but the 3<sup>rd</sup> person cannot ask directly the 1<sup>st</sup> person</p>	
<p>4. After drawing, the resource person shows the original pictures and compare them to the pictures drawn by the groups to each group and to all the members to see which group can draw closest to the original pictures.</p>	<p>1. Original pictures</p>
<p>5. Resource person invites students to exchange ideas from doing the activity, what they learn and how they feel.</p>	
<p>6. Resource person let students see a video clip to conclude the benefits of adding friendship.</p>	<p>1. A 10-minute video clip about befriending.</p>
<p>7. Resource person concludes the overall picture.</p>	<p>1. Knowledge sheep/Conclusion Guideline for resource person</p>

The researcher arranged the RQSAS into a book form with illustrations and beautiful colors in the A 5 size convenient to transport and use as illustrated. in Fig. 1

**Figure 1** Sample of Activities Set in the format of A 5



**Source:** Manual for Conducting Activities “Refilling Power, Creating Immunity” (Ammaret Netasit, 2013)

## **2. Results of using the developed RQSAS with disabled students at DSS, LPRU.**

During the students participating in the process of the developed activity set, overall behavioral observations showed students cooperated, very interested and very happy in the activities and could be seen clearly that the behaviors of the students were according to the objectives of the activities. The students behaviors during the RQ activities had the details as follows:

**Mold than Chang Activity.** From the activity, it was found that the students could analyze and know their own emotions, tell how to control their emotions, have the ability to analyze and have a very high level of creativity.

**Open Box, Open Heart Activity.** It was found that the activity helped student to have the opportunity to present positive thinking and methods of problem solving to their friends and that had other students learn positive thinking and problem solving methods. Students also had a good attitude towards themselves and those around them too.

**Tree of the Future Activity.** The result of this activity could be seen clearly that it made students know how to set their own goals leading to future success. Moreover it made students have positive thinking, encourage them to help each other and have a good human relationship for living together.

**Tell and Draw Activity.** It was found that doing this activity made disabled students have the effort to communicate differently to different categories of disabled persons. They practiced the skills to deliver and receive messages. It trained them to be more observant including having harmony and practiced working with others. Most importantly, the activity was fun and very pleasant.

## **3. Results of the assessment of RQ of disabled students at DSS, LPRU.**

The RQ support for disabled students at DSS, LPRU with the whole disabled students as the population evaluated before and after using MHET from the Mental Health Department, Ministry of Public Health with the details of assessments as follows:

**Emotional Stability.** The pre-test before the activity found that the students had RQ lower than normal criteria 29.62%, normal criteria 70.38% and no students with RQ higher than normal. After the RQSAS the post-test found the students lower than normal 14.81%, normal 77.78% and higher than normal 9.52%. This showed the development of reduced number of students with RQ lower than normal 14.81 % and increased students with RQ normal of 7.4% and increased number of students with RQ higher than normal 9.52%.

**Mental Power.** The evaluation of the RQ before the activity found students with RQ lower than normal 40.74%, Normal 59.26% and none higher than normal while after the RQSAS activity, the number of students with lower scores was 7.40% and with normal scores of 92.6%. This showed the development of reduced number of students with RQ low of 33.34% and increased of students with normal RQ scores of 33.34%.

**Problem Management.** From the pre-test, the number of students with RQ lower than normal was 55.56% and normal 44.44% with none in the higher level but after

the activity, the students with lower than normal scores was 7.41%, normal scores was 88.89% and higher than normal was 3.70%. This showed the number of students lower than normal was reduced 48.15% and normal scores increased 44.45% and higher scores increased 3.70%.

### **Suggestions for application researches**

The research findings had suggestions for teachers, DSS personnel and educational personnel or interested persons wishing to us this RQSAS with the disabled students as follows:

1. To follow the process of the activity set “Refilling Power, Creating Immunity” the resource person/assistant resource persons must operate according to the roles specified as follows:

1.1 The opportunity to participate in the activity should be opened to all students.

1.2 During the activity, students should be encouraged and opportunity opened to the students so they become successful to create confidence and pride in themselves.

1.3 Resource persons must create the warm and friendly atmosphere to do the activity together.

1.4 Resource persons should listen to student’s opinions, be neutral and in case of problems, they must be judged fairly.

1.5 Resource person must plan time management appropriate for the number of students participating in the activity.

1.6 Conducting activities by stressing the students can learn by themselves. The resource person team supports and encourages the students to learn according to the objectives of the activities.

1.7 This activity set works with different categories of disabled students. There may be some limits during the activity period so the resource persons/assistant resource persons should help disabled students if necessary.

1.8 The resource persons must be able to conclude the problems clearly and find the right meanings of the issues.

The assistant resource persons are very important during activity period, apart from being the assistant resource persons during the activity such as distribute and collect various equipment during the activity, help conclude the subject matter or opinions from the activity etc. and during the activity, some students may need help so the assistant resource persons must help the disabled students as necessary.

2. The activity set “Refilling Power, Creating Immunity” is the set that can support RQ for only students with visual disability, hearing disability and physical disability not including disabled students with intelligence or brain disability so the users should use it with appropriate groups of disabled students as specified in the set only.

3. During doing the activity, there must be an assistant sign language for students with hearing disability apart from the regular resource persons and assistant resource persons so students can understand correctly to do the activity and can communicate to other students during activity.

4. The research findings showed the time needed for each sub-activity was 1.30 hours and to do all four activities need one day from 8:30 to 16:30 hours. The activity time may be adjusted and planned according to the number of participating students. Moreover some specific activity could be applied and used in teaching and learning as needed.

5. Every sub-activity has a knowledge sheet/conclusion guideline for resource person with details appropriate to the activity, in accordance with the creation of RQ by the Mental Health Department Ministry of Public Health and in accord with the each activity objectives. The conclusion of the resource person should think of the context of joint activity too so the knowledge sheet/conclusion guideline for the resource person are only a guideline, the resource person may adjust them to suit each activity as needed.

### **Bibliography**

- Phayathai Independent Living for Disabled Persons Center. History. 2012. (online) source: <http://www.ptilc.net> (2012, 30 June)
- National Support and Quality of Life for Disabled Persons. 2012. Statistics of Disabled Person according to Sexes and Regions. (online) source: <http://www.nep.go.th> (2012, 29 June)
- Ammaret Netasit. 2013. Manual for Conducting Activity “Refilling Power, Creating Immunity”. Bangkok. Decemberry Limited.
- Krippendorff, Klaus. 1980. Content analysis: An introduction to its Methodology. Californis: Sage Publication.

*Effect of Transpersonal Psychotherapy in Reducing Symptom of Craving and the Level Dependency in People with Substance Use Disorder*

Diah Fridari, Indra Surya, Eko Budi, Aninditha Veera, Karina Putri, Puspasari Dewi,  
Ayana Wiria

Udayana University, Indonesia

0236

The Asian Conference on Psychology & the Behavioral Sciences 2013

Official Conference Proceedings 2013

Abstract

The numbers of young people who addicted to drugs in Bali has been increasing every year and it has reached a very concerning numbers. Not only the prevention of spreading drug use that need to be focused on but also the management for those who already using drugs, so they can be productive and free from their addiction. The healing process for the people with substance use disorder is a difficult process. Relapse could occur during the process. With the support from family and friends and high motivation and will from the patients, the relapse will be able to minimize. This study aims to determine the impact of the Transpersonal Psychotherapy in people with substance use disorder. The intervention given to reduce the symptoms of craving so they continue to decreasing the level of dependence on the addictive substances. The study will also aim to accelerate and facilitate the healing process. The method of this study is using the experiment method with single case experiments approach. There is 10 subject's research and the interventions administered for 5 weeks. Intervention given is Transpersonal Psychotherapy, healing trough Pure Awareness. The expected outcome of this research is that the pain is reduced when patients going through the withdrawal conditions and it will affect the level of dependence on the drug. Detailed results and implication will be discussed further in a comprehensive manner.

Keywords: Addiction, Craving, Substance Use Disorder, Transpersonal Psychotherapy

## I. BACKGROUND

The population of young people who use narcotics, psychotropic and other addictive substances (drugs) becoming alarming. According to the data from National Narcotics Agency (BNN), the number of drug addicts in Indonesia has reached between 3.8 – 4.2 million people. The actual number is greater than the data reported because many addicted people have not been detected. This figure is predicted to continue growing, considering the money circulating in the drug business is so huge that more parties want to get involved.

Drug abuse usually begins with an offer from a friend for free and used to forget problems until finally the level of dependence on the drug has increased and he/she becoming a drug addict (Yusinta, 2004). Various preventive efforts against drug trafficking among the young generation have been done, but the numbers of drug addicts keep increasing. The drug problems are very complex, not only about the prevention but most important is the treatment for those who are addicted to drugs. There has not been an instant or magic treatment to free people from drug addictions, according to BNN RI (2009) there are stages of change that will be developed by a drug addict to be totally free from drug abuse. The stages are:

1. Pre-contemplation  
On this stage, the addicts may not aware of their addiction. They deny their problem being addicted to drugs.
2. Contemplation Phase  
The addicts understand the problem they are facing, and want to do something about it but do not know how to start.
3. Preparation  
On this stage the addict ready to take action. They feel that they can face the challenge and the obstacles.
4. Action  
This stage shows how the addict have taken the decision to stop using drug and start the treatment program that offered or chosen for them. Relapse will likely happen on this stage. The addicts struggle to cope with the withdrawal condition.
5. Maintenance Phase  
The addict has sober and healing process to maintain this condition continues. Social support will play the most crucial role in helping them to stay in the sober stage.

Resource: Book of *Pencegahan Penyalahgunaan Narkoba Sejak Usia Dini*, BNN RI, 2009

Based on those stages of recovery which is not easy to go through, the researcher intend to help addicts in the 4th stage where the person have taken the decision to stop using drugs and show serious behavior to reduce the use of drugs. One of the indicators that show drug addicts have taken the decision to stop taking drugs is to go and seek treatment or rehabilitation for them to be free from the addictive substances. Considering this stage is a critical stage and they need as much help they can get to keep them motivated and managed their emotions in order to survive in achieving their goal to be free from drug addiction, the researcher intends to help them by providing Transpersonal Psychotherapy during the process.



## II. RESEARCH METHODS

The research method that will be used is an experimental method; ABAB single case where A1 and A2 are Baseline 1 before patients receive psychological therapy and B1 and B2 is an Intervention 1 and Intervention 2. (Barlow & Hersen, 1984; Myers & Hansen, 2002 in Nurlaila EF, 2008).

A1: Baseline 1 (basic 1)      B1: Intervention 1 (Therapy 1): Transpersonal Psychotherapy

A2: Baseline 2 (basic 2)      B2: Intervention 2 (Therapy 2): Transpersonal Psychotherapy

The baseline is condition where the clients were given methadone, nutritionist food, and social support from the therapist. The difference between the baseline and the therapy is on the intervention given by the therapist.

Psychological intervention that will use in this research is the method of Transpersonal Psychotherapy. Transpersonal Psychotherapy is a therapy which will use higher level of consciousness. Individuals will see themselves as a whole and not just the body. Transpersonal Psychotherapy is the process of transcendent consciousness, allowing exploration of the pre-opening awareness and deeper level of human beings, the higher self, the true self or inner self (Strohl, 1998). There are several methods of Transpersonal psychotherapy (Greenberg, 1999; Rowan, 2002) such as: meditation, psychosynthesis, contemplation, intuition, yoga, biofeedback, breathing training, mental focus, visualization, dreams, imagery, and communications within. These methods are used in research by Kabat, et al. (1992); Mills, et al. (2000); Boorstein (2000); Greyson (2002); Sutherland, et al (2001); Rowan (2002); Bonnadona (2003); Khim et al. (2005). The new method was introduced in Indonesia is a method of healing through pure awareness where human access to physical and psychological healing through her own body (Adrianto R., 2010). Pure awareness is a state, a condition which you experience everything. It is attribute of you that is your awakesness, your aliveness. (Stone, 2007). When the clients experience the pure awareness, the body becoming aware and react to heal its own body.

The stages in the study are going through several phases, such as:

- Phase I : Counseling and rapport
- Phase II : Preparation (an introduction to relaxation processes)
- Phase III : Initial therapy (relaxation, mind focus and pure awareness healing)
- Phase IV : Therapy with pure awareness healing and distance healing
- Phase V : Last week of therapy (therapy through pure awareness and meditation)
- Phase VI : Evaluation and understanding life purpose

The stages of therapy are mentioned below:

Stage	Activity	Time
I.	Introduction to relaxation and mind focus	1 day
II.	<ul style="list-style-type: none"><li>- Relaxation</li><li>- Meditation</li><li>- Pure Awareness Healing</li></ul>	2 weeks
III.	<ul style="list-style-type: none"><li>- Relaxation</li><li>- Meditation</li><li>- Pure Awareness Healing</li><li>- Distance healing</li></ul>	4 weeks

Starting the initial therapy, the clients had been given the form of psychological homework that they need to do and report the feeling and condition every day. They were asked to do breathing technique every morning as soon as they woke up and before go to bed at night. Once a week we had meeting to discuss their overall conditions.

### III. LOCATION AND DATA COLLECTION

Participants are patients in Methadone Clinic, Sanglah Hospital, Denpasar – Bali, who already stop using narcotics and also want to stop using methadone. Initially there were 10 participants willing to participate but only 7 participants who follow the therapy until the end. They have been informed the process of this research and signed the informed consent to show a firm agreement between researcher and participants. The participants will receive Rp. 250.000/month for transportation allowance and lunch and drink every meeting. We meet every week with the date and time agreed by both parties. The meeting took place mostly in Methadone Clinic, Sanglah Hospital. Collecting data were done by using depth interview and observation by co-researcher where one co-researcher focus on maximum 2 participants. All participants were also asked to fill the form of psychological homework where they were asked to do the breathing technique each morning and night and noted how they feel, physically and emotionally.

### IV. RESULT and DISCUSSION

This study conducted in two months starting January – March 2013. All participants gathered to receive therapy once a week. The beginning of this study, there were 10 participants, all male, age between 30 to 55 years old, but only 7 people who managed to follow this research until the end. The three people who cancelled their participations could not meet our schedule for meeting

and therapy. The result of this study was a descriptive data consist of their Curriculum Vitae, history of addiction, emotional and health condition in daily self report.

This study use the single case experimental design is to see the effect of intervention / effect of therapy. The challenge using the experimental design is extraneous variables, internal validity and confounding (Myers & Hansen, 2002). Those factors had been controlled during the study but there are still possibilities that some distraction might affect the result. We use the evaluation sheet that simple and easy to fill, therefore the clients won't have to be burden with so many questions. We also use constancy of condition to control the effect by using the time of intervention, same instruction and same procedure during therapy. The researcher also did in depth interview during the study to know each person's experience so it can be used as the data to analyze the effect of therapy in each individual subject research. On the second stage of therapy, the clients were easily done the relaxation and meditation as they were already had their first stage experience. The relax condition is the most important part to let the healing through pure awareness to happen.

This discussion will explain how the psychotherapy transpersonal (relaxation, meditation and healing through pure awareness) give impact to the condition of people with substance use disorder. The connection between physical condition and mental condition is very strong. The transpersonal psychotherapy technique is using the inner power, focus on oneself until the transformation of awareness occur. That transformation will make the integration in physic, mind, soul and spirit, and the healing process begin. This integration make a harmonious condition between physical body and mental. The pure awareness technique make the healing process happen so fast. That's why it also called a quantum healing. The word that comes to mind when a scientist thinks of such sudden changes is quantum. The word denotes a discrete jump from one level of functioning to a higher level, the quantum leap. Quantum is also a technical term, once known only to physicists but now growing in popular usage. Formally, a quantum is "the indivisible unit in which waves may be emitted or absorbed". (Chopra, 1990). The transformation of level consciousness related to the body is in the neurophysiology system such as neurotransmitter, brain/neocortex, hormones, and also immune system. With routine meditation, it had been proved to lower the stress hormones (Hyness, 1999). Meditation is lowering the oxygen consumption, and lowering the breathing process, heartbeat and make the entire body relax. With The Pure awareness technique, the goal is to cultivate a state of being in which the experience of Pure Awareness is never lost, to live in a state of being in which Pure Awareness is never overshadowed by all the other experiences of life. When you have cultivated this state you attain a permanent state of inner peace that is undisturbed by even the most circumstances (Stone, 2007). Before given the therapy, the clients faced a stressful condition about their addiction, feeling anxiety and feeling helpless. After the therapy, they feel much better to accept their condition, and feel that they can do something about their addiction. Meditation as the way to self centered, to focus on the right here and now condition, to be able to regulate their selves so they are not worried about the future nor the past. Meditation is also allowing the clients to lower their negative emotions that will impact their self balance. Subjects who do meditations learn to believe inner nature and wisdom that will help to recognize the person's responsibility (Albeniz and Holmes, 2000) and it makes them to accept their condition of addiction is their responsibilities. Accepting and being responsible of what the client's condition bring out the positive aspects of their selves.

Discussion on each subject based on their history of life, daily form, and in depth interview and observation. The client's experience, background and history of client's life, their personalities give different effect of the result of Transpersonal Psychotherapy. The subjects who followed this therapy are 7 subjects (GB, WR, LR, MF, AR, ST, IA). All subjects suffered from insomnia, addicted to caffeine and nicotine. MF has problem with his sugar level on his blood (diabetes) and IA has problem with his left hand (his bones on his left hand hurt because of accident couple years ago). After given the therapy, all of them can sleep well at night and the insomnia is gone. They had a quality sleep and feel better and fresh in the morning. The significant reduce of coffee consumption and cigarette show in every subject. IA, LR, and MF used to drink more than 5-12 cups/day and smoked 12 -24 cigarettes. After the therapy, they are not enjoying coffee and cigarette that much, the consumption of coffee 2 – 3 cups /day and 3-6 cigarettes/day. MF had stable level of sugar in his blood since the therapy given until now. IA does not feel the pain in his left arm anymore. All subjects feel their health is getting better. They also feel that their relations with family member are improving. MR now spent a lot of time with his son than he ever done. Others have better way of communication with wives and other relatives. The withdrawal condition could not been measure as they continue using the methadone. The doze of methadone reduced as per doctor's prescription.

## V. CLOSING

Based on this study, people with substance use disorder who have made their decision to stop using drugs facing difficult times avoiding from relapse. They need social support and psychotherapy to help them maintain their motivation to stay away from drugs. The psychotherapy concept that including the medical aspects, good nutrition, social support, counseling and psychotherapy are needed to accelerate their healing process to be free from drug or methadone. Transpersonal Psychotherapy made some changes of attitude and behavior as there is an integration result between body, physiological, mind, soul and spirit. Psychotherapy Transpersonal with relaxation, meditation and pure awareness healing gave significant change in the subject's life. The greatest contribution to the addiction conditions is the addicted to caffeine and nicotine that reduce significantly while the reduction of level dependency of drugs and methadone do not show the significant results yet. The improvement of overall health's condition increase their productivity in work area, better communication with family and more calm in dealing with their addictions. They have become more optimistic to be able to get better and free from addiction.

## VI. REFERENCE

- BNN RI (2009) Pencegahan Penyalahgunaan Narkoba Sejak Usia Dini. Jakarta
- Choopra, D (1990). *Quantum Healing*. USA: Bantam Books
- Effendy, N. (2008). Pengaruh Psikoterapi Transpersonal terhadap Kualitas Hidup Pasien HIV & AIDS. Disertasi
- Ekman, P. (2003). *Emotions Revealed*. New York: Henry Holt and Company, LLC.
- Firman, J. (2010). *Psychotherapy of Love*. New York: State University of New York Press
- Fragar, R. (1999). *Heart, Self, & Soul*. Wheaton, IL. USA: Theosophical Publishing House.
- Hadi, S. (2004). *Metodologi Research Jilid 4*. Yogyakarta: Andi.
- Hafen, B.Q., Karren, K.J., Frandsen, K.J., & Smith, N.L. (1996). *Mind, Body, Health. The Effects of attitudes, Emotions, and Relationship*. Massachusetts: Allyn & Bacon
- Hart, T. (2000). *Transformation as Process and Paradox. The Journal of Transpersonal Psychology*, 32(2), 157-164.
- Hawari, D. (2004). *Terapi dan Rehabilitasi Mutakhir Pasien NAZA*. Universitas Indonesia Press
- Hawkin, D.R. (2002). *Power vs Force. The Hidden Determinants of Human Behavior*. Arizona: Veritas Publisher.
- Rowan, J. (2002). *The Transpersonal*. New York: Brunner-Routledge.
- Rueffler, M. (1995). *Our Inner Actor*. New York: Psycho Political Peace Institute Press.
- Suryani, L.K dan Wrycza, P.J. (2003). *Living in the Spirit*. Denpasar: Pustaka Bali Post
- Stone, T. (2007). *Pure Awareness*. Great Life Technologies, Carlsbad, CA.
- Strohl, J.E. (1998). Transpersonalism: Ego Meets Soul. *Journal of Counseling & Development*, 76, 397-403.
- Tart, C.T. (1975). *Transpersonal Psychologies*. London: Harper & Row
- Wilber, K. (2004). *The Simple Feeling of Being*. Shambala Publication
- Wilber, K. (2000). *Integral Psychology*. Boston: Shambhala Publication.
- Wilber, K. (2002). *The Spectrum of Consciousness*. Delhi: Motilal Banarsidass

Wilber, K. Engler, J., & Brown, D.P. (1986). *Transformations of Consciousness*. Massachusetts: Shambala Publications, Inc.





*A Developing Second-order Measurement Model of Thai Adolescent's Desirable  
Characteristic*

Panidaporn Jongrache, Puntip Sirivunnabood, Penpilai Rithakananone

Chulalongkorn University, Thailand

0167

The Asian Conference on Psychology & the Behavioral Sciences 2013

Official Conference Proceedings 2013

Abstract

Over the past decades in Thailand, some educators fixed the students' desirable characteristics in order to becoming the primary educational indicators for teachers' measurement. However, those characters did not cover all domains in developmental psychology and had no systematic and scientific research conducted to develop such a measured instrument. The present study adopted a comprehensive and rigorous procedure to develop a multifaceted scale for Thai adolescent's desirable characteristic through an empirical investigation. The definition and measurement of adolescent's desirable characteristic (ACD) were important for comprehensive understanding of Thai adolescences. The conceptualization of ACD integrated different streams of literature. Furthermore, ACD simultaneously considered first-order and second-order measurement models as well as the structural model comprising 5 primary domains: physical, cognitive, emotional, social and moral, and emphasized on developing expanded conceptualizations of these characters by modeling them as second-order factors and expressing their defining constituent domains of content as first-order factors. The fit indices showed that the model fitted the data well. The major findings were (a) ACD was a multidimensional constructs and scale indicating good psychometric properties for reliability, a content, convergent and predictive validity, and (b) factor consisting of 5 domains, each of which consisted of 4,6,4,7, and 8 indicators. The empirical findings provided a more succinct picture of ACD, and the well-validated scale could be used as a basis for further research and theoretical groundwork in the field of adolescent's desirable characteristic.

**Keywords:** desirable characteristics, Thai adolescences, second-order measurement model

## 1. Introduction

A characteristics is similar to the words “attribute” or “trait” and desirable is close to the term “worth having”. So, the term “desirable characteristics” refers to the specific traits of an individual that are defined as good or ethical human behaviors including beliefs, values, and acts.

Thai society has been affected from foreign cultures over the past decades, which influences toward development of Thai youth personality. In order to reform the country, Thai government realizes that she has to start with developing people as the first goal. The direct way to reconstruct characteristics is through education. Therefore, Ministry of Education, Thailand (2002) has proposed that education management needs to emphasize both knowledge and virtue for developing Thai student as a complete person, fulfilled with good manners, intelligence, happiness and Thai value. Moreover, some educators in Thailand have attempted to fix the 8 good characters: patriotism, honesty, orderliness, seeking knowledge, sufficiency living, working hard, love in Thainess and public mind, in Standard-based curriculum (2008) as the primary educational indicators for measurement (Ministry of Education, 2010). According to the theory of developmental psychology (Hurlock, 1955; Santrock, 2007; Boonprakob, 2002; Rithakananone, 2007), those characteristics do not cover all domains in developmental psychology: physical, emotional, social, and intelligence. In order to improve Thai students in accordance with desirable characteristics, the researcher recognizes the importance of a good measurement. From many research about character measurement in Thailand, the researcher has found that most of measurements are quite similar in measuring morality without the systematic development of the full multi-dimensional measurement model as stated in developmental psychology.

Therefore, the purpose of this study was to develop a multifaceted, 5-dimensional scale for Thai adolescent students’ desirable characteristics based on developmental psychology as an empirical investigation. These students were both male and female from extra large secondary schools in Bangkok, Thailand. Hence, understanding Thai adolescent students’ desirable characteristics structure could help the teachers, their parents and the psychologists promote personality development and character formation of Thai secondary school’s students.

## 2. Literature review

In the field of developmental psychology and education, desirable characteristics are important indicators of how individuals have good manners or believe. Sirivunnabood (2002) classified the Thai behaviors supporting the country development in 5 fields: social behaviors, political behaviors, personal behaviors, environmental behaviors and economic behaviors. Chareonwongsak (2003) framed the future image about desirable characteristics of Thai people in 5 domains: physical, mind, knowledge, skill and existence. The Office of Basic Education Commission (2004) studied the qualities of desirable Thai children from 2,150 people and analyzed contents as Thai traits framework, the results of which were concluded in 9 indicators; personality and behavior, intelligence and skill, moral and virtue, responsibility, occupation, love in Thainess, health and sanitation, technology and civic duty.

Among the various researches and frameworks in Thailand, the definition and measurement of adolescent's desirable characteristics (ACD) were important for comprehensive understanding of Thai adolescences. The conceptualization of ACD integrated from different streams of literature. The researcher summarizes the Thai adolescent's desirable characteristics in 5 domains; physical domain, intelligence and skill domain, emotional domain, social domain and moral domain, based on student's desirable characteristics from the National Education Act (2002), Fundamental Education Curriculum (2005) and Standard-Based Curriculum (2010) accompanied with research of Chareonwongsak, K. (2003), Pienchob, S. (1982), Nickanong, C. (2001) and Department Of Mental Health (2000) to formulate the ACD model, presented as a hypothesized second-order measurement model of adolescence's 5-dimensional desirable characteristics in Fig.1.

The logo for 'iafor' is centered on the page. It consists of the lowercase letters 'iafor' in a light blue, serif font. The text is enclosed within a circular graphic composed of two overlapping, thick, brush-stroke-like arcs. The upper arc is light blue and the lower arc is light red, creating a partial circular frame around the text.

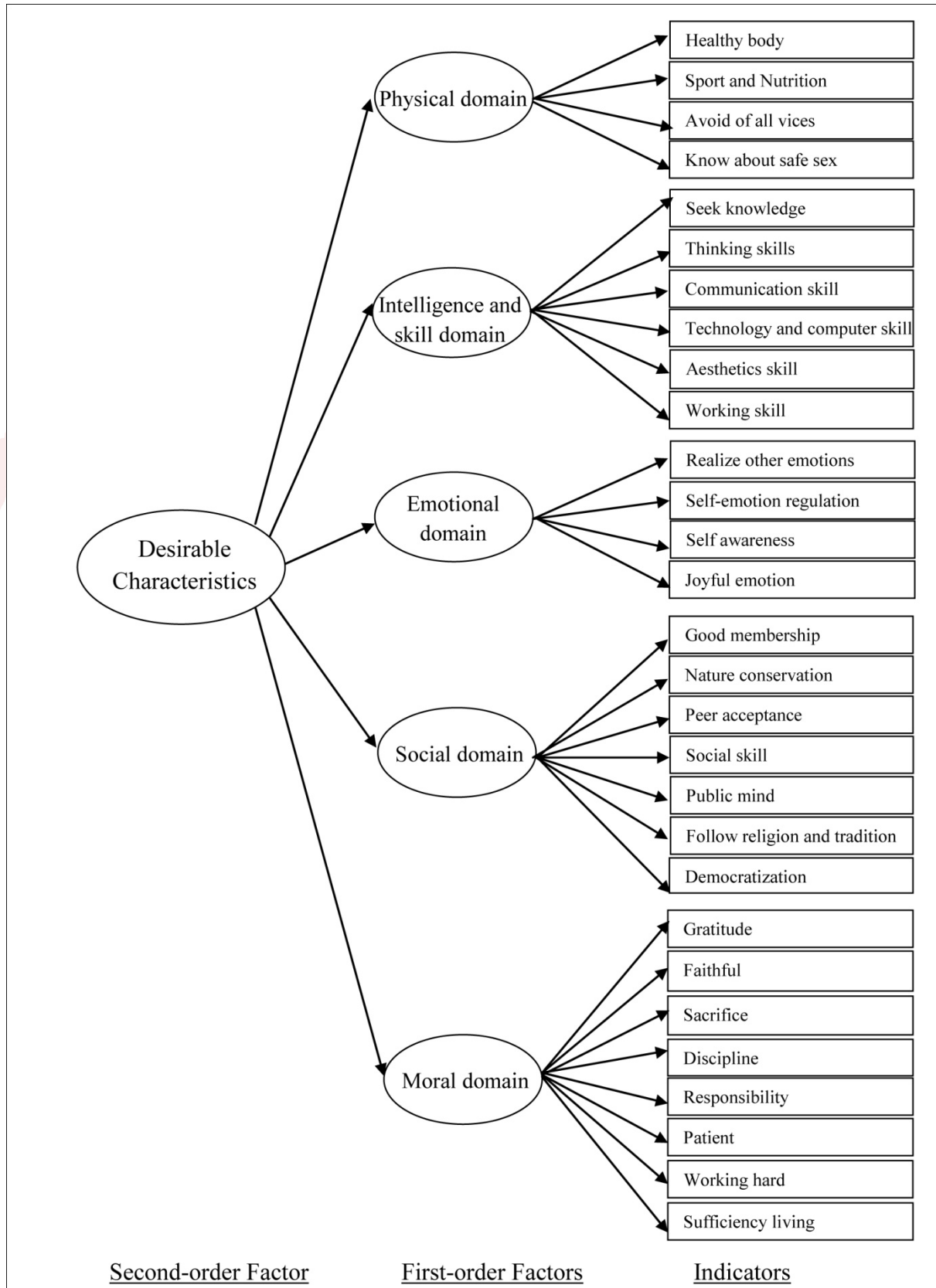

Fig.1 Hypothesized second-order measurement model  
 of Thai Adolescence's Desirable Characteristics

### **3. Method**

#### *3.1 Participants*

There was 194 students participated in this study. These students studied in Grade 8 and 11 from 2 extra large secondary schools in Bangkok; Surasakmontree School and Wat Nuannoradit School. We randomly selected the schools by using Lottery method. The 194 students consisted of 90 male students and 104 female students, aged from 155 to 213 months with a mean of 183.98 (SD = 18.56).

#### *3.2 Survey and procedure*

The design of 5-dimensional ADC scale in Thai version for measuring Thai adolescence's desirable characteristics (ADC) was a self-report questionnaire with five-point Likert-type scale ranging from 'mostly have' to 'least/never have' consisted of 5 factors and 29 indicators, based on the evidences from literature review. The ADC scale consisted of 5 subscales that are aimed at assessing physical, cognitive, emotional, social and moral domains following the theory of developmental psychology and Thai social context. The scale development process comprised of the following stages: a) defining the theoretical and operational definition, b) drafting of 200 items, 5-7 items for each of the 29 indicators, c) checking for content validity by 3 experts possessing professorship in developmental psychology, d) pre-testing the scale with 122 students from 2 Bangkok secondary schools, and estimating for Cronbach's alpha reliability, the result of which were very good with .79, .92, .90, .95, and .94 for the those 5 indicators respectively, e) screening of the three best items, as suggested by Jöreskog and Sörbom (2001), for each of the 29 indicators to develop the short form of the scale, using the corrected item-total correlation (CITC). As a result the final developed ADC scale consisted of 5 factors, 29 indicators and 100 items.

The next step was to validate the measurement model of the developed ADC scale. Firstly, the short form of the ADC scale was examined for face and content validity by 4 professors in developmental psychology, 1 professor in educational psychology and 1 secondary school teacher in educational conduction. Secondly, the ADC scale was used to collect the data by means of a survey. We set the sample size based on the criteria suggested by Hair et al. (1998) of at least 5 units for each parameter in the measurement model. Since our model had 63 parameters, therefore the sample size should be 315. Unfortunately, we could get only 194 students (82 in Grade 8 and 112 in Grade11), from two secondary schools in Bangkok as our research sample.

#### *3.3 Data analysis*

Data were analyzed in three following stages: Firstly, we estimate for Cronbach's alpha reliability of the 5 factors underlying the ADC scale. Secondly, we analyzed the data using the second order factor analysis using LISREL to check for construct validity. Prior to the analysis, we used normality test and Bartlett's test for sphericity to check for the required statistical assumptions.

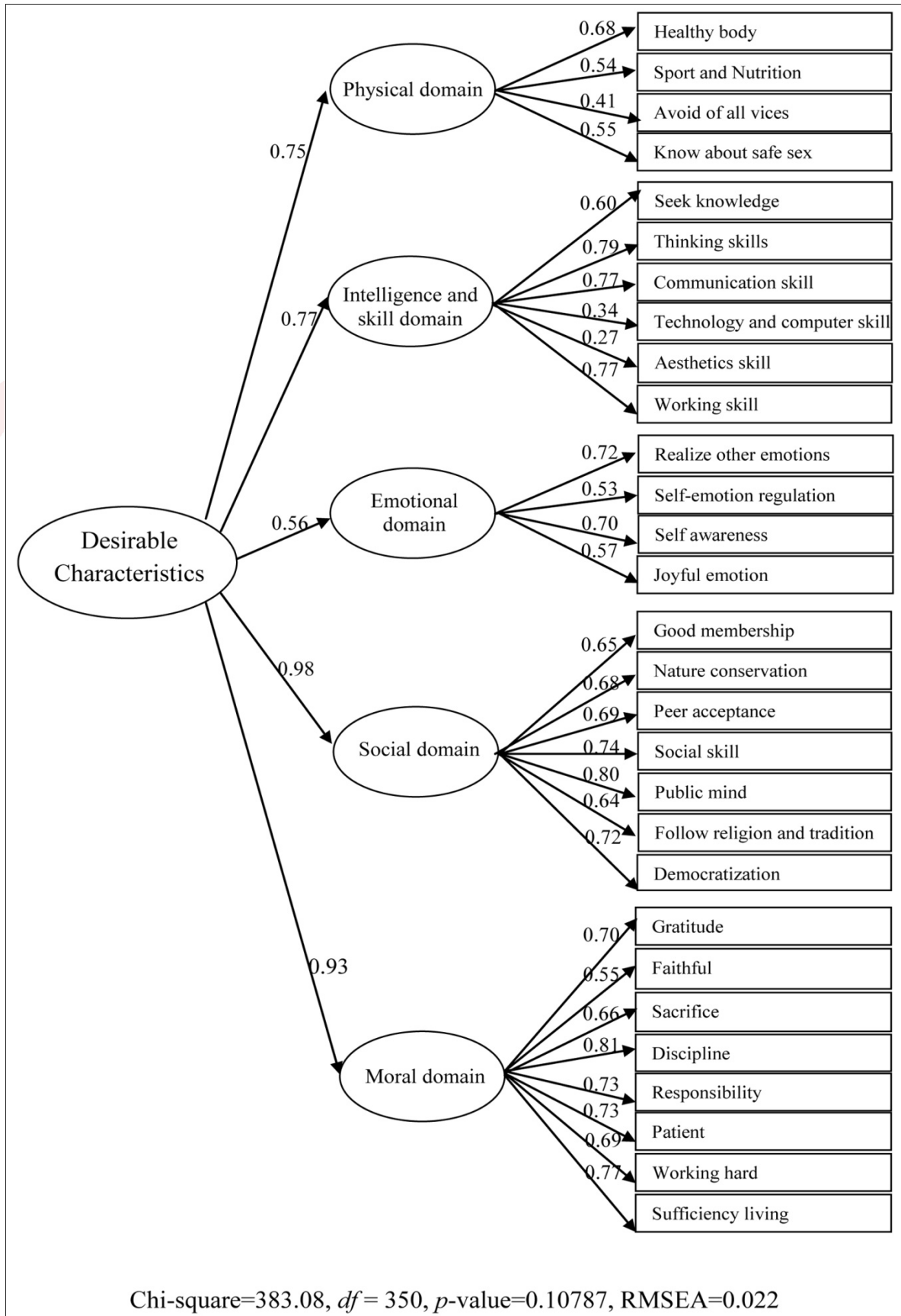

Fig.2 Final second-order measurement model of Thai adolescent's desirable characteristics



## 4. Results

### 4.1 Reliability analysis

The values of Cronbach's alpha for each of the five factors of the ADC short form scale were .73, .87, .84, .93, and .92, respectively, indicating quite good internal consistency of the developed ADC scale.

### 4.2 Confirmatory factor analysis

The underlying structure of the measurement model of the ADC short form was displayed in the above Fig.1. The tests of skewness and kurtosis indicated the normal distribution of all 29 indicators. The Bartlett test of sphericity (2898.740,  $df = 406$ , at  $p = .000$ ) and the Kaiser-Meyer-Olkin measure of sampling adequacy ( $KMO = .923$ ) indicated that there were sufficient relationships among all 29 indicators to conduct factor analysis. The result of the second order factor analysis using LISREL indicated that the measurement model of the ADC short form scale was satisfactory valid or fit to the empirical data with chi-square value = 383.08,  $df = 350$ ,  $p < 0.05$ , RMSEA = 0.022, RMR = 0.21, CFI = 1.00, GFI = 0.88, AGFI = 0.85, as shown in Fig.2.

The confirmatory factor analysis results revealed the highest significant and the lowest loadings of the indicators for the first-order factors as follows: healthy domain (.64) and avoid of all vices (.41) for physical domain, thinking skills (.79) and technology and computer skills (.34) for intelligence and skills domain, realize other emotions (.72) and self emotion regulation (.53) for emotional domain, public mind (.80) and follow religion and tradition (.64) for the social domain, and discipline (.81) and faithful (.55) for moral domain.

## 5. Discussion and conclusion

We present a new questionnaire to assess desirable characteristics in Thai adolescents; the ADC scale. The main purpose of this study was to develop a multifaceted scale of desirable characteristics in adolescent students. The ADC was designed to cover the domains in the theory of developmental psychology. The measurement model supports our idea that the ADC could assess more specific domains. In addition to its favorable psychometric properties, the ADC is short in length, making it easy and cheap to administer.

The importance of desirable characteristics has been documented in the literature of educational and developmental psychology. And it is used as an index of an individual's behavior and development. However, very few studies in the educational and psychological literature have examined the basic structure of the desirable characteristics. If the teachers understand the students' characteristics, the teachers can then develop effective program for students to improve good personalities and increase positive thoughts.

Data were collected from 194 students enrolled in Grade 8 and 11 in Bangkok secondary schools, Thailand. CFA were conducted to confirm students' desirable

characteristics structure. The results of CFA confirmed the presence of a second-order measurement model of desirable characteristics. The fit indices provided empirical evidence of a well-fitted model.

The structure model contains five primary factors/domains and one second-order factor with relations that correspond to ADC constructs and scale demonstrates good psychometric properties for reliability, and content validity and factors consisting of 5 domains, the indicators of which were 4,6,4,7, and 8 of observed variables measuring from 3-5 items respectively. Moreover, the secondary-order factorial structure helps provide a more parsimonious framework to explain the ADC.

This study shows that secondary school students' desirable characteristics centered on social and moral domains ( $\gamma = .98$  and  $.93$ ), which indicates that students value the behaviors that affected other people are good characters. They are less concerned about self ( $\gamma$  for physical, intelligence and skill was  $.75$  and  $.77$ ). The emotional domain was the lowest contributor among students' desirable characteristics ( $\gamma = .56$ ). This could be due to the influence of culture and tradition in Thai society, which encourages sympathy and considerateness among youth.

Moreover, the influence of the Thai culture is shown in how the students' characters affect the other's perceptions upon themselves. They also care about self-concept but it was not as important as social and moral domains. Like several researches on desirable characteristics of Thai students (Pienchob, 1982; Nickanong, 2001; Limchumroon, 2008), the mostly good characters in youth and teachers' opinions are moral attributes and behaviors that make people happy or are gained acceptance from others.

It is also important for future researchers to compare students' desirable characteristics with those of adolescents in other provinces, regions or different ages (age group). A study on the similarities and differences in desirable characteristics among adolescents with different regions will enable teachers, educators, parents and developmental psychologists to understand which characters are unique among adolescence students. This can help educators and who concerned with developing practical programs or activities to promote and retain good characters of students. In addition, understanding how much desirable characteristics in adolescence students can help the teachers improve students with completed developmental domains.

The strength of this study was that it utilized (was the utilization of) the second-order CFA to validate structure of desirable characteristics and ADC scale which demonstrated good psychometric properties for reliability, and content validity. However, the main limitation of this study is in the generalizability of desirable characteristics. Because the data were collected in Thailand, the factor structure can only represent Thai adolescents' desirable characteristics perceptions. It is suggested that cross-cultural comparison studies be conducted to examine the possibility of generalizing the second-order factor structure onto different subjects with different cultural backgrounds.

## 6. Acknowledgements

I would like to thank the Graduate School and Faculty of Psychology of Chulalongkorn University, Thailand for giving me the opportunity to present this paper. Furthermore, I would also like to acknowledge Associate Professor Dr.Puntip Sirivunnabood and Associate Professor Dr.Penpilai Rithakananone, my advisor and co-advisor for encouraging me and paying attention to this research and all of the students who provided me with the information for this study. Last but certainly not least, thank you to my family for emotional support throughout my doctoral project.

## References

- Boonprakon, W. (2002). *Development of children and adolescent's personalities*. Bangkok, Thailand: Beyond enterprise.
- Chareonwongsak, K. (2003). *Picture of the future and desirable characteristics of Thai people*. Bangkok, Thailand: Thai study project.
- Hair, J.F. et al. (1998). *Multivariate data analysis* (5<sup>th</sup> ed). Upper Saddle River, NJ: Prentice-Hall.
- Hurlock, E. B. (1955). *Adolescent development* (2<sup>nd</sup> ed). New York: McGraw-Hill Book Co., Inc.
- Jöreskog, K. & Sörbom, D. (2001). *LISREL 8: User's reference guides* (2<sup>nd</sup> ed.). Lincolnwood: Scientific software international.
- Limchumroon, P. (2008). *The development of a toolkit to measure desirable characteristics of lower secondary school students*. Educational research Program, Faculty of Education, Chulalongkorn University, Thailand.
- Ministry of Education. (2002). *The National Education Act (1999) and 2th revised version (2002)*. Bangkok, Thailand.
- Ministry of Education. (2005). *A study of standard of Thai children that society desired*. Bangkok, Thailand: Bureau of academic affairs and educational standards.
- Ministry of Education. (2005). *Fundamental Education Curriculum (2001)*. Bangkok, Thailand: Office of the basic education commission.
- Ministry of Education. (2010). *Standard-Based Curriculum (2008)*. Bangkok, Thailand.
- Nickanong, C. (2001). *The development of the causal model of desirable characteristics of Thai males and females as perceived by upper secondary school students in Bangkok Metropolis*. Bangkok, Thailand: Educational research Program, Faculty of Education, Chulalongkorn University.
- Pienchob, S. (1982). *Desirable characteristics of Thai youth*. Bangkok, Thailand: Chulalongkorn University.
- Rithakananone, P. (2007). *Human development* (2<sup>nd</sup> ed). Bangkok. Thailand: Thammasada Press.
- Santrock, J.W. (2007). *Adolescence* (11<sup>th</sup> ed.). Boston: McGraw-Hill
- Sirivunnabood, P., et al. (2002). *Study of pattern of relationships between contemporary behaviors of Thai people and socialization process of Thai families in relation to the development of the country*. Bangkok, Thailand: Chulalongkorn University.

*An Analysis of Film Voice-Over and Sound Interpretation Techniques from a Cross-Cultural Perspective*

Chun-Wen Fang\*<sup>1</sup>, Li-Chieh Chen\*<sup>1</sup>, Chin Shin Chen\*<sup>2</sup>

\*<sup>1</sup>Tatung University, Taiwan, \*<sup>2</sup>China University of Technology, Taiwan

0281

The Asian Conference on Psychology & the Behavioral Sciences 2013

Official Conference Proceedings 2013

Abstract

While using the element, "cross-culture", as the movie theme, the part that is easy to bring about debate and discussion mainly consists in the movie's presentation techniques that may or may not fully present its respect and understanding to the interpreted cultures. This essay took two movies, *Good Men*, *Good Women* and *Café Lumière*, directed by Taiwan movie producer, Hou Hsiao-Hsien, as examples to investigate, through the aspect of cross-culture, how "Film Voice-Over" and "Sound" can interpret cultural conflicts and cultural integration and whether the application techniques of "Film Voice-Over" and "Sound" interpret specific cross-cultural implications.

By using interview method, this essay analyzed and investigated the interactive relationship between "Film Voice-Over" and "Sound" during the narration of the movie among different cultures. From results obtained from the interview and as well as from the structure of film text, this essay also analyzed the implication and correlations among different administrative levels. Besides, from the cross-cultural issue reflected in film text, this essay, through movie's perspective, observed and probed into the implicated meanings.

Keywords: Cross-culture, Film Voice-Over, Sound, Hou Hsiao-Hsien, Cultural conflict, Cultural integration

## Introduction

Movie producer, Hou Hsiao-Hsien, is one of the most important representative figures for Taiwan's new movies in 1980s. Ever since 1983 till today, his movies have received many international awards in various film festivals including the Cannes Film Festival and the Venice Film Festival. His filming aesthetic style not only is unique but often reflects and reviews Taiwan's past history in his productions to provide audiences with opportunities to understand Taiwan's history. Screenwriter, Chu Tien-Wen, who has been worked with him for a long time, once mentioned that Hou uses an alternative way to observe the world in different angles. His movies are comprehensions and as well as expressions of interpretations. (Chu Tien-Wen 1985)

*A City of Sadness* (1989), *Puppet Master* (1993), and *Good Men, Good Women* (1995) are called "Taiwan Trilogy". In *A City of Sadness*, Hou illustrates Taiwan's transition period from Japanese Administration to Kuomintang Administration. The movie brings many frictions and identifications on national identity and attributes. In *Puppet Master*, by national treasure class hand puppet master Li Tien-Lu's autobiographical movie, Hou states stories of Taiwan during Japanese Administration Period. *Good Men, Good Women* is a movie that describes stories in staggered time frame among the past and the modern time. The movie is composed of three stories and presented in the way of "drama in drama". It describes theatre actress Chiang Bi-Yu's physiological feelings and persecutions in reality as a political victim in about 1940 to 1950. Patriotic youth, Chung Hao-Dong and Chiang Bi-Yu were politically purged due to their presence in the left-wing political activity. Chung Hao-Dong in the end was shooting-executed by the government. Besides, the past story between Liang Ching and her ex-boyfriend were also brought up. By staggered time reflection, the movie shows the unique Hou-style movie language.

*Good Men, Good Women* is the last movie in "Taiwan Trilogy" by Hou Hsiao-Hsien. This movie states the different political atmosphere and society status in Taiwan history at the time when Kuomintang Government took over the administration power from Japanese, and it also reviews the important white terror issue in Taiwan history through the case of "Keelung High School Guangming News", where Chung Hao-Dong, Chiang Bi-Yu and others were involved. Hou uses the main actress's voice narration to run through and connect three different time and space backgrounds. And the staggered use of different languages like Mandarin, Taiwanese, Japanese, and Hakka language reflects the use and identity of complicated cross-cultural languages. (Wu Chia-Chi 1997)

Themed at family relationship, in *Café Lumière* the main actress Yoko (played by Hitoto Yo) has a Taiwanese boyfriend. She plans to have a child without marriage relationship and raise the child by herself. The whole movie depicts the connection and interaction between friends and parents, the destined and inseparable emotions about Taiwan, her persistence in searching for deceased Taiwanese musician Chiang Wen-Yeh's past footprints, and her silent supports to her special friend, who loves recording the sound of tram cars everywhere. Voice expression in this movie is considered having important position. With Hou's commonly-used "long take" approach, all the details including all kinds of sounds in the tramway station and inside the tram cars are smoothly, calmly, and slowly presented in the frame. *Café Lumière* is a production to commemorate Japanese movie producer Ozu's(小津安二郎) 100 years old birthday in the nether world. Very often, Hou Hsiao-Hsien's movies are used for comparison with Ozu's works.

In the film seminar in Hong Kong Baptist University in 2007, Hou Hsiao-Hsien once mentioned that Ozu's specialized in placing the simplest issues and elements in our daily lives into his movies that transmit all the messages in a gradual and implicative way. (Cho Po-Tang 2009)



## Interviewees

There are two interviewees in this essay. One is Taiwan's famous director, Mr. Yu Kan-Ping, who invests himself into Taiwan's new movie production in the corresponding period of time with Hou Hsiao-Hsien. He has been engaged in film and television work for nearly four decades and has served as a judge and chief of the jury in Taiwan's Golden Horse Award and a full-time professor in universities. Currently he is the dean of the Department of Popular Performing Arts, Chungyu Institute of Technology, Taiwan.

Mr. Chen Wen-Pin is a screenwriter and also a movie producer. He has put efforts into studying Hou Hsiao-Hsien's movies for a long time. The directed "Everlasting Moments" was nominated for competition in Singapore International Film Festival and Heidelberg International Film Festival in 2011. The directed "No Puedo Vivir Sin Ti" was elected the Best Actor in Taipei Film Festival and the Best Original Screenplay in the Golden Horse Award in 2009. Currently he is a deputy professor in the Department of Motion Pictures and Video Communication, Chung Chou University of Science and Technology, Taiwan.

Both interviewees, using Hou Hsiao-Hsien's two films, *Good Men, Good Women* and *Café Lumière* as example; focusing on cultural conflict, cultural integration and whether the films expressing the specific cross-cultural implications section; provide their views and resolve different levels of special film language.

## Cultural Integration

As for cultural integration, Director Chen is of the opinion that *Café Lumière* expresses issues relating to the main actress, her parents and her family. It is similar to Ozu's style that often brought up the concepts of family and traditions. In this film, because of giving birth to a child without marriage, the main actress had different views with her parents. The filming technique is similar to the illustration of daughter and father's relationship in Ozu's movies *Early Spring* and *An Autumn Afternoon*, only that *Café Lumière* has even richer family dramatic tension. The author think, this film is very popular in Taiwan. People in Taiwan have high degree of cultural integration toward Japanese culture. For example, the tram car and domesticity that show up in the film are not new for Taiwan people. Suite that was composed by Taiwanese composer Chiang Wen-Yeh in the film drew the main actress's feelings and echoed to the real life, i.e. the environment Chiang Wen-Yeh was at and the cross-national cultures that go across Taiwan, Japan, and China, for historical comparisons.

Different cultural integration: vulnerable due to pregnancy as a metaphor of being in the busy city, Yoko's dream implicating the meaning of movie, and the paintings of leading actor, Hajime, baby surrounded by layer of trains, presenting individual and urban space, complex relationship of intimacy and alienation; while tram with the familiar sound of the rhythm, becoming a symbol of the global city, also plays an important role in the film. (Wenchi Lin 2007)

The author think for a long time Hou Hsiao-Hsien often bring up questions in film to probe into cross-cultural issues and subjects relating to Taiwan's plight. From the selection of actors, *Café Lumière* makes an even clearer expression on cross-cultural awareness. The choice of the main actress (Hitoto Yo) clearly presents the story's background across Taiwan and Japan. The film was taken in Japan and was recorded in Japanese. Many scenes were taken inside tram cars. The process of sounds includes Hitoto Yo's vocal, tram car's sound elements like the sounds of tram car and the broadcasting, and main actor's (played by Asano Tadanobu) vocal to state his own feels and the warm atmosphere between himself and the main actress. The sounds of tram cars



are particularly obvious in the film. While in the final scene, where leading actor Hajime, with his handheld equipment recording the sound of passing train on the platform, in fact, this scene was shot by the film crews who camouflaged as the passengers on the platform. This also shows a Hou's style filming technique: filming without rehearsals, can not be predicted. (Zhang Liang Bei 2009)

As for cultural integration, Director Yu mentioned that Director Hou Hsiao-Hsien has very strong humanitarian color. In *Good Men, Good Women*, Hou views and handles the relationship between people, extensively to the whole family and then ultimately to different nations and races with humane and tolerant mindset. People's helplessness and compromise to their destiny is confronted by challenges and tests of the times. Sometimes, there exist certain degree of criticisms about the authority of the time; however, Hou Hsiao-Hsien often chooses not to name the names directly. And the film voice-over is presented by the technique of natural language, which is considered a kind of cross-culture's cultural integration to truly present the realistic facets of different cultures and lives. Through realistic intention of showing a narrative style, the basic concern is the "human". Humane care becomes very important feature in Hou Hsiao-Hsien's film, through day-to-day life, the film slowly talking about the true face of the Taiwan society and history. (Wenchi Lin 2000)

### **Cultural Conflicts**

Some non-realistic style and sense of abstract are from Hou's rather special recording technology. Director Hou's mixing different layer of sound is one of methods for him to stay away realism. He transforms one sound source to another sound source. In *Good Men, Good Women*, *Café Lumière* and other Hou's films, the movie characters often appear in: listening carefully to the voice from other end of cell phone or deliberately maintaining a sense of mystery through the fax machine sound. (Adrian MARTIN 2008)

In the area of cultural conflicts, Director Chen is of the opinion that while speaking of the cultural conflicts in *Good Men, Good Women* in the sounds part, the director's cross-cultural presentation technique is to focus on the main actress, Chiang Bi-Yu, and relate to left-wing intellectual youth's activities in the Japanese Colonial Period. And there are three cultural conflicts and three cultural elements: 1) Japanese Culture - Intellectuals that received Japanese education in the Japanese Colonial Period (in Japanese). 2) Chinese Culture – In order to look for his motherland, the main actor came to China and participated in anti-Japanese activities. But he was considered a traitor in China (i.e. his motherland) (in Chinese). 3) Local Culture - the main actor and the supporting role was Hakka. They spoke Hakka in the rural area, where in between Guangdong and Fujian. By main actor and actress's destiny, the movie sets out the cultural conflicts among Taiwan, China, and Japan, and as well as Taiwan's plight in Japanese Colonial Period.

### **The implication to present specific cross-cultures**

A long time partner of Ho in film making and an extremely important sound designer in Taiwan, Tu Du-Chih has excellent performance in handling sound; from as early as *The Boys from Fengkuei* (1983) till now. Tu creates an unique and expressive sound aesthetics. Started from the *A City of Sadness*, Hou Hsiao-Hsien used live recording during the filming to express the realism of different sound in different space. Such technique has appeared in the narrations of several Hou Hsiao-Hsien's movies. It transforms the element of text with cross-media and express that with sound. (Ling Zhang 2010)

Director Chen is of the opinion there are songs in different languages, including Hakka, Taiwanese, and Mandarin, in *Good Men, Good Women*. Among which, some songs, like “*Why don't we sing*”, were forbidden songs at that time. In the music part, Hou Hsiao-Hsien likes to use songs that are sung by Taiwan local singers like Tsai Chen-Nan and Tsai Chiu-Feng. And most of these songs are very popular among people of the underlying social class and synthesize the dreams of both the people from underlying social class and the intellectuals (the dream of intellectuals refers to songs that were prohibited at the time when Kuomintang held the authority). Some Taiwanese songs were even not heard or considered not existed before Hou's movie came out.

The author thinks that Hou Hsiao-Hsien choose film songs, we can see his affections and attitudes toward Taiwan are inclined to the life of left-wing underlying social class. The presentation of main actor's OS and VO shows Hou Hsiao-Hsien's unique movie language. In the area of sounds processing, the title of *Good Men, Good Women* comes the sound of fax machine, and the television in the living room is playing Director Ozu's movie. Director Chen think, the appearance of main actress's vocal is just like a key to open up the whole film and lead audiences to go into Chiang Bi-Yu's world in the past. Through the design of sounds, the film guides audiences go into different scenes or time frames. The technique just shows a typical Hou Hsiao-Hsien film. Hou often puts important figures and issues in Taiwan's history into his story, such as Wen-Yeh Chiang in the *Café Lumière*, Chiang Bi-Yu and Chung Hao-Tung in *Good Men, Good Women* (although these people are not mainstream figures, but they did have important position in Taiwan's history).

Director Yu mentioned that as for sounds utilization, because of social environment, natural language is customary used to increase the film's factuality. This depends on a style, which uses first-person to subjectively illustrate the issue to present specific cross-cultural implications. Chu Tien-Wen is a screenwriter that Hou has been worked with for a long time. He provides many helps on the writing languages, i.e. uses the first person to narrate the story. Sounds were produced in the recording studio. And the narration is done in the way of voice-over, so the audiences can connect fragments into one complete story by the sense of hearing.

## **Conclusion**

From a higher level of cultural perspective, Hou Hsiao-Hsien utilize Taiwan's history and her status as the main theme of thinking on the structure of the movies to present cross-cultural related issues. To deal with the changing of time (for example from 1940s to 1960s) in his movies, Hou uses elements of sound to render the time, spatial variability and issues related to cross-cultural. It is Hou Hsiao-Hsien's unique filming style to extensively use voice-over and monologue. Using different local language or dialogue in the movie to truly present a reality and diversity of the story. The use of local language in the movie, Hou Hsiao-Hsien wish to imply the complicated racial and social issues of different identity, conflict and reconciliation in the society. His goal is to present a truly cross-cultural level of meaning.

Two of his movies *Good Men, Good Women* and *Café Lumière* represent the special film culture in Taiwan from early 80s to early 2000s. It was the time when Taiwanese consciousness on the rise and Taiwanese society was seeking its true identity from her own history. In the mix of Taiwanese consciousness and transnational culture, this different historical cultural experience give birth a unique film language and cultural implications. In his films, Hou Hsiao-Hsien touched the somewhat then forbidden and still sensitive topics of "white terror" and tragic February 28 incident in Taiwan's modern history. This can be follow-up study relate to the current research by adding social ideological element to explore Hou Hsiao-Hsien's unique way

to tell a historical and social sensitive story. Furthermore, analyzing and comparing the filming style of realism and means of interpretation between Hou Hsiao-Hsien and late Japanese director Ozu(小津安二郎) can provide a direction of additional research in the future.



## References

Adrian MARTIN. 2008. What's happening? Story, scene and sound in Hou Hsiao-Hsien. *Inter-Asia Cultural Studies*.9(2), 267. ISSN 1464-9373.

朱天文, 1995. *好男好女：侯孝賢拍片筆記、分場、分鏡劇本*. 台北：麥田. ISBN 9577082890

卓伯棠, 2009. *HOU Hsiao-Hsien Master Class*. Guangxi Normal University Press. ISBN 978-7-5633-8401-3.

Ling Zhang. 2010. Through the Acoustic Membrane of Memory: Voice-over and Soundscape in Hou Hsiao-hsien's *The Puppetmaster*. *Film Appreciation Academic Journal*.7(2),34-35. ISSN 1018-1245.

林文淇, 2000. 侯孝賢早期電影中的寫實風格與敘事. In: 林文淇、沈曉茵、李振亞. *戲戀人生-侯孝賢電影研究*. 台北：麥田, pp.101. ISBN 957-708-953-4.

吳佳琪, 2000. 剝離的影子-談《好男好女》中的歷史與記憶. In: 林文淇、沈曉茵、李振亞. *戲戀人生-侯孝賢電影研究*. 台北：麥田, pp.314. ISBN 957-708-953-4.

張靚蓓, 2009. *聲色盒子：音效大師杜篤之的電影路*. 台北：大塊文化. ISBN : 9789862131459.

iafor

*Medical Morality in Islamic Civilization*

Gholamreza Montazeri

Gorgan Agricultural and Natural Sciences, Iran

0379

The Asian Conference on Psychology & the Behavioral Sciences 2013

Official Conference Proceedings 2013

Abstract

Medical ethics is based on two principles: science and ethical commitment and it presents a clear image of ethical values and tasks appropriate for a doctor in a community. Physicians' commitment to these spiritual principles – derived from religious lessons and experiences of well-known scholars of Islamic civilization – increases rate of their success in treatment of patients and plays an important role in effective communication between colleagues and social environment. In this article it has been tried to explain ethical values and principles briefly such as virtue and piety, trusteeship, respect and compassion, sacrificing, building trust, commitment, justice, modesty, meritocratic, avoiding jobbery, accepting critique and etc.

Keywords: medical ethics, Islamic civilization

## Introduction:

Health of human's Soul and body is very important in religious teachings. Healthy body is considered as a proper bed for growth and prosperity of mind and thought and perfection of human's spirit, for this reason it is regarded as "God's Gift" and due to its effective role in health and welfare of human society, medical science was placed as one of the most useful and noblest science after religious sciences.

Islamic civilization gave privileged status to medical science and profession and outstanding figures were scout of this science in Islam world including Abu Ali Sina, Zakaria Razi and Ismaeel Jorjani. With growth of medical knowledge, medical ethics is one of the subjects which has been considered by sages, philosophers and physicians of Islamic era and was established in well-known medical texts of this era such as: Ibn Sina "Law", Razi "Alhavi" and Ahvazi "Advice Book".

## Ethics in Islamic Civilization

"Ethics" lexically means habit and behavior and it is said to internal and spiritual features of mankind. Morality changes realm of human vision and directs to privacy and respect for others; hence it can be regarded as Model of successful communication with others. Medical ethics which is relied on dos and don'ts of doctor and his manner to others, includes principles and values that presents a clear image of internal commitment of doctor for environment (intrinsic and extrinsic). Commitment to these spiritual principles – which are derived from religious doctrines and experiences of well-known physicians and scholars of Islamic civilization – both increases the rate of success of physician in carrying out his job and plays an effective role in communication with colleagues in treating patients. It includes:

### 1- Virtue and piety:

The doctor who deals with life and property of people, for being protected from possible slips, he can trim himself with divine virtue.

### 2- Trust in God

Life and death are in power of god, so a doctor besides of his effort should rely on god for healing.

### 3- Commitment to religious values.

### 4- Secret-keeping and secrecy

Information of patients is trust to doctor, so his secrecy can protect personality and honor of patients. In a part of Hippocratic oath which muslim doctors and student of this field should take an oath by it, says: ".....those things which I see or hear at the time of treating my patients ... I avoid revealing them and I believe that we shouldn't reveal these kinds of things .." (History of Hospitals in Islam, p 54)

Zakaria Razi emphasized on it and said:" oh my son! It is worthy and important that a physician be a friend of people and be confident of their secrets, since some people hide their disease even from their closest relatives but they inevitably reveal it for doctors." (Advice and Promise in Medicine, p 67)

### 5- Skill and proficiency

Having knowledge, skill and capability are important conditions of entering this holly profession and a person without this skill and knowledge should avoid accepting this responsibility, since he threats health of patients and honour and dignity of doctors



would be deteriorated. Imam Sadeq mentions: “every owner of profession should have 3 characteristics: 1- He should be proficient in his work 2- he should be trustworthy 3- he should make interest in that person wants to apply. (Tohafol Oghool, p238)

In a contrastive and comparative expression, Razi reminded the threat of those doctor-like people who lack skill and expertise and wrote: “ ... you should know that robbers and thieves are better than those pretender doctors but not real doctors, because robbers steal properties but doctor-like people do many things to the life of people...”( Advice and Promise in Medicine, p 98)

6- Keeping training and researching

Exploiting new knowledge and continuous effort increase the success of doctor and facilitates treatment.

7- Avoiding jealousy

Jealousy makes piece away from doctor and it reinforces suspicion and mistrust in medical society.

8- Respecting patient

Respecting patient increases dignity of doctor and has positive effects on soul and body of patient.

9- Sacrificing:

Sacrificing shows dignity and honor of doctor and it is the highest human behavior.

10- Creating trust in action

Trust in doctor is the most important social capital for them. This capital is the result of honesty, precision, and ethical and practical report of doctors and it provides doctors to climb the summit of success.

11- sincerity (in case of women)

It is worthy to doctor treat women with decency.

12- Humility and modesty

Modesty towards patient and co-workers makes doctor glorify and popular among people. Based on religious teachings, Razi emphasized on modesty and kindness in increasing attraction and success of doctors and said: “...you should know that in this job modesty in the form of soft and nice words and avoiding bad-tempered is art and beauty. Every doctor who behaves like this will be prosperous.” ( Advice and Promise in Medicine, p 100)

13- Kindness and compassion

Doctor is a friend of patient and with kindness and courtesy he brings hope and mirth to patients. In an Islamic Hadith we read: “once Hippocrates said to his student: let your given love, your devotion to their work, your awareness about their conditions be your behavioral tools to people.” (p 208)

14- Commitment to accountability culture

Believing in responding to society is an important medical ethics.

According to it, society has the right to ask doctor about his behavior and doctor should consider answering it as his ethical duty.

15- Accepting criticism

Accepting criticism prepares development and rejecting criticism begins Stagnation and inaction.

16- Feeling of responsibility and commitment

Doctor is responsible of patient and he knows his treatment as his duty.

17- Justice –oriented

Doctor should be fair in treating rich and poor patient. His effort should not increase or decrease. Patient is a human whether poor or rich. We can see from practical report of Islamic doctors that they helped poor people more and if they needed, doctors gave them monthly salary for treatment.

18- Abstain from alcohol

Vinosity reduces doctor's personality and it increases his error and slip during treatment.

19- Avoiding Jobbery

In belief of Islamic scholars, medicine is not a business and a physician is not a business man. Therefore it is not appropriate for a doctor to consider just material things and fame-seeking. Rahavi, author of Adib-otabib or "Practical Ethics of Doctor" believes that: "Art of medicine is honourable and a doctor is not trying to get money but he tries to get everlasting joy, reputation and infinite rewards of god." (Advice and Promise in Medicine, pp 214-215)

20- Respecting patient's privacy

References:

- 1- Ibn-abi asibe'e, Aun-ilbana bel-akhbar-ol-hokama, Research, "Nazar Reza, Beirut: Dar ol-maktaba al-ahya 1965"
- 2- Qafti, Akhbar ol-olama bel-akhbar ol-hokama. Cairo: first edition, 1329 "
- 3- Ahmad Isa Bek, History of Hospitals in Islam, Translation by Noorollah Kasae – first edition – 1992 scientific and cultural publication
- 4- Saket, Mohammad Hossein, Advice and Promise in Medicine, first edition, 1999 – VajIran
- 5- Morteza Aameli, Jafar, Customs of Medical Science, translation by Latif Rashedi
- 6- Najmabadi, Mohammad, History of Medicine in Iran, Tehran, Tehran University Publication, second edition, 1987
- 7- SHalbi, Ahmad, History of Education in Islam, translation by Mohammad Hossein Saket, Islamic Culture Publication, Tehran, 1981
- 8- Medical Ethics, Collection of Articles, first edition, 1991

The logo for 'iafor' is centered on the page. It consists of the lowercase letters 'iafor' in a light blue, serif font. The text is enclosed within a large, light blue circular arc that is partially visible at the top and bottom. A faint, light red circular arc is also visible behind the blue one, creating a layered effect.

*Bilingualism Helps Asian Families Flourish*

Gina Ko

Athabasca University, Canada

0441

The Asian Conference on Psychology & the Behavioral Sciences 2013

Official Conference Proceedings 2013



iafor

iafor  
The International Academic Forum  
[www.iafor.org](http://www.iafor.org)

## A Literature Review: Bilingualism Helps Asian Families Flourish

Some first or second generation Asian immigrants choose to teach and immerse their children in their native language, while others choose not to. This literature review investigates some possible reasons behind this decision. The advantages of immersing children in their first language will be discussed. To present a balance, it is important to present the disadvantages of doing so. In addition, the disproportionate number of advantages versus disadvantages, as evidenced by the literature, will be highlighted. For the purpose of this paper, native language is defined as the first language spoken by parents, other than English. Furthermore, references to culture will be specifically to ethnic culture. By the end of this paper, I hope to present that it would be beneficial for Asian immigrants to immerse their children in their native language due to the significant cultural and cognitive benefits this would harvest.

### Advantages of Immersing Children in a Native Language

#### The Cultural Perspective

When immigrants come to Canada, they have to make a decision regarding the extent to which they wish to preserve their distinct cultural uniqueness (Arthur, Merali, & Djuraskovic, 2010). In addition, they need to decide how much they want to connect with others who do not share their cultural traditions. In this section, the positive cultural benefits of immersing children in a native language will be explored. One such benefit is that it may make the acculturation process of family members go more smoothly (Boutakidis, Chao, & Rodriguez, 2011; Costigan & Dokis, 2006). By being familiar with one's native language, it may help one remain bicultural (Costigan & Dokis; Kim & Omizo, 2006; LaFromboise, Coleman, & Gerton, 1993). The ability of speaking the family's native tongue, may aid one to connect more deeply with their ethnic culture (Boutakidis et al; Costigan & Dokis). It may also assist in reducing the generational gap experienced by immigrant families (Costigan & Dokis, 2006; Boutakidis et al., 2011; Wu & Chao, 2011).

**The process of acculturation.** Some immigrants may be more acculturated (Berry, 2005); whereas others may be slower to adapt to the greater culture. Berry defined acculturation as, "the dual process of cultural and psychological change that takes place as a result of contact between two or more cultural groups and their individual members" (p. 698). In other words, acculturation involves the progression of how one becomes comfortable with living in a new and foreign environment. The rate of acculturation is different for each individual and each family who immigrates. Costigan and Dokis (2006) found that immigrants who settle in Canada generally fair well. In this study, families were drawn from the community and acculturation was measured with independent results from parents and children. In general, the child participants reported low intensities of struggles, low depressive indicators, and high achievement incentive. This occurred despite different experiences of acculturation compared to their parents. Furthermore, immersing children in their native language strengthened the bond of the family. For instance, when children adjust to the Canadian culture at a faster rate, their parents may feel they are losing their ethnic identity. However, with the common spoken

language of Chinese, they are able to share a more collective experience, regardless of the rate of acculturation (Boutakidis et al., 2011).

**The bicultural experience.** Biculturalism is, “the integration of the home and host cultures in terms of both lifestyles and interaction patterns” (Arthur et al., 2010, p. 289); the aim is to remain in the midpoint between isolation from other groups, and complete assimilation into the greater culture. Therefore, when Asian immigrants immerse their children in their native language, whilst continuing to encourage them to learn English, it could create an optimal balance. As mentioned above, Costigan and Dokis (2006) conducted a study of immigrant Chinese families; they wanted to find the relationship between parent and child rates of acculturation, and individual and family adjustment in the host country. Results of the study indicated that it is vital to offer programs to uphold immigrant children’s sustained participation in their ethnic culture, while, at the same time, they also attain the skills needed to blossom in the new country.

In addition, Kim and Omizo (2006) voiced that developing an affirmative Asian American identity is connected to engaging in Asian behavioural norms. This includes the use of the Asian language. Furthermore, they also suggested that Asian Americans should participate in European American norms to remain bicultural. Consequently, LaFromboise and colleagues (1993) concurred that it is essential to hold both cultural groups in a positive light. They relayed that, without positive views about both groups, one may be inhibited by the ability to feel good about interacting with both cultures. In essence, the teaching of a native language to preserve the ethnic culture, and the encouragement of learning English, allows children to appreciate both cultures.

**The sense of connection.** There are many words in Chinese that are not equivalent in English. When one speaks English with a parent, the connection is not as profound, as there are many ways he or she is not expressing the exact sentiment. A study conducted by Boutakidis and colleagues (2011) agreed with this assertion. They found that Chinese and Korean adolescents, who were able to communicate with their parents in their native language, had a better understanding of their native culture. This is because they were, “able to understand and express these values within the cultural and linguistic context in which they originated, further aiding their understanding of the parent’s values and perceptions” (Boutakidis et al., p. 130 ). In this light, language is more than a medium of communication; it offers a deeper level of sharing within a culture.

Moreover, when parents and children are able to share their native language, the process of learning about their customs and traditions become more ingrained. Costigan and Dokis (2006) relayed that when mothers speak Chinese, and the children do not, their difficulties in communicating with each other, make it challenging to share emotional concerns. On the other hand, children who were more analogous to their mothers in adhering to the Chinese culture, such as showing a willingness to learn and speak Chinese, may experience more support in their families (Costigan & Dokis, 2006). Hence, this study emphasized the emotional benefits of being able to communicate in a native language.



**Minimizing the generational gap.** The benefits of being able to speak the native language may transpire into communicating more effectively with parents. As indicated above, Berry (2005) voiced that older and younger people may acculturate at different rates. For example, parents may lag behind their children in terms of getting acquainted with the host culture. A study conducted by Wu and Chao (2011) asked participants in grades 10 to 12 to complete a 50 minute questionnaire; this measured parental warmth, parental-adolescent open communication, Chinese parent-adolescent relationships, and adolescents' internalizing symptoms. The questionnaire was completed by 249 Chinese American (95 first-generation and 154 second-generation) adolescents and 385 European-American adolescents in the greater Los Angeles region. First-generation pertains to adolescents born outside of the United States to immigrant parents; and, second-generation pertains to adolescents born in the United States to immigrant parents. The results indicated that second-generation adolescents experienced higher levels of adjustment problems when they answered questions regarding parental warmth, when compared with European Americans. The difference was not indicative when comparing first-generation adolescents and European Americans. In addition, second-generation adolescents were more prone to experience internalizing symptoms.

Overall, there was a greater degree of cultural dissonance in the second-generation group, such as in parental warmth and open communication; there was also an increased rate of behavioural problems for these Chinese youth (Wu & Chao, 2011). For this group, greater discrepancies were associated with generational gaps encompassing two types of stress. These were, "acculturative pressures and normative generational gaps" (Wu & Chao, p. 503). As indicated above, when adolescents were able to share a common native language with their parents (Costigan and Dokis, 2006), and were able to communicate fluently in the native language, it was possible for the adolescent and the parent to share a collective sociocultural perspective (Boutakidis et al., 2011). In essence, more unity may be possible, and therefore decreases the generational gap experienced by adolescents. The benefits of teaching children a native language include the possibility of bringing the rates of acculturation closer for the parent and the child. It fosters the youth's biculturalism to a greater degree. In addition, the sense of connection becomes stronger. Furthermore, it may help to close up the generational gap experienced by many immigrant families.

### **The Cognitive Perspective**

In contrast to the early twentieth century (Hakuta & Garcia, 1989), there is presently an array of research that points to the cognitive benefits of bilingualism. First, bilinguals have more choice in language expression (Gollan & Ferreira, 2009; Rodriguez-Fornells, Balaguer, & Munte, 2006). Second, another benefit is that proficient bilinguals, ones who are equally as proficient in two languages, may perform above monolinguals in terms of mathematics and language classes (Kempert, Saalbach, & Hardy, 2011). Subsequently, they have higher functioning in executive control (Bialystok, Craik, & Luk, 2008; Kempert et al., 2011); which will be defined below. Lastly, their brains are more fit and may delay the onset of dementia (Adesope, Lavin, Thompson, & Ungerleider, 2010; Bialystok, et al., 2008; Mechelli et al., 2004).

**The bilingual brain has more choice.** Rodriguez-Fornells and colleagues (2006) found that fluent bilinguals interchange from one language to the other, and are able to isolate both languages entirely without much struggle. Later, Gollan and Ferreira (2009) agreed that knowing two languages offers advantages such as the ability to communicate to a wider audience, and function in a larger diversity of language situations. They also communicated that bilinguals have the power of choice when speaking with other bilinguals; they have the flexibility of selecting whichever language most straightforwardly and distinctively convey their thoughts. In essence, bilinguals enjoy more freedom of expression when it comes to language use.

**Proficient bilinguals have advantages in academics.** In Kempert and colleagues' (2011) study, they found that students of Turkish and German elementary bilingual schools had to keep two languages separate by recurrent usage and exposure. The students, who were proficient bilinguals, indicating that they were skillful in both languages, performed better in math problems with distractors, compared to students who were monolinguals. Furthermore, bilingual students were apt to have more attentional control than monolingual students. Positive attentional control involves the degree of flexibility in interchanging attention between, and within tasks to make the most out of performance (Derakshan & Eysenck, 2009). In Kempert et al.'s study, proficient bilinguals had higher scores compared to their monolingual peers on these tasks. It may be significant to underscore the relationship between performing well in mathematics and also excelling in learning languages. Hence, Kempert and colleagues' study is an important one to note in regards to the benefits offered to proficient bilinguals.

**Bilinguals have higher executive control.** Furthermore, Kempert and colleagues (2011) found that bilingual children possess cognitive benefits such as executive control. Pessao (2009) defined executive control as a set of, "functions, typically believed to depend on the frontal cortex (and probably the parietal cortex), which are needed when non-routine behaviors are called for – namely, when 'control' is required" (p. 160). In other words, executive control provides one with the ability to set and reach goals, inhibit a tendency to do wrong, and keep focus when attention is needed (Hughes & Ensor, 2007). In Kempert et al.'s findings, even immigrant students with a weak grasp of the German language (language of instruction), performed at an equal level in executive control tasks compared to their monolingual peers. Therefore, even nonbalanced bilinguals (one's who are more proficient in one language compared to the other), profit from being bilingual.

In another study, Bialystok et al. (2008) also found that bilinguals performed better in tasks that require executive control compared to monolinguals. This study incorporated the Stroop task. Miller et al. (2001) indicated that the Stroop task incorporates, "asking the subjects to either read words or name the colour in which they were written" (p. 168). For example, if the word is green, however, is written in red, the reader would be asked to name the colour; this requires one to focus on only one attribute at a time. In Bialystok and colleagues' study, bilingual subjects fared better than monolingual subjects in these tasks. In combination with other tests, they were found to have higher executive control in general. Hence, both Kempert and colleagues' (2011) and Bialystok and colleagues' studies pointed toward the positive benefits in terms of having higher functioning in executive control tasks.

**The bilingual's brain is more fit.** Mechelli and colleagues (2004) indicated that when one learns a second language, the grey matter in the left inferior cortex becomes bigger. This may help in the postponement of dementia for an average of four years. Furthermore, Bialystok and

colleagues' (2008) study found that knowing two or more languages enhances the progress, as well as defers the decline, of executive control on a number of tasks; this was evident across the lifespan. Specifically these results were found in nonverbal tasks as well, which were not knowingly related to language processing.

In addition, Adesope et al. (2010) performed a meta-analysis research of 63 studies and found that balanced bilinguals were, "associated with several cognitive outcomes, including increased attentional control, working memory, metalinguistic awareness, and abstract and symbolic representation skills" (p. 207). Therefore, they exceeded monolinguals in metalinguistic and metacognitive awareness. In addition, in this project, attentional control was strongly correlated with bilingualism. Subsequently, Adesope and colleagues found that these advantages were present regardless of participants' socioeconomic status (SES). Therefore, the bilingual brain may benefit from being exercised beyond the ones that are only exposed to one language.

The bilingual brain has shown to be more flexible in that it may function in multiple language environments. In proficient bilinguals, they were found to perform more effectively in certain mathematical concepts. In regards to executive control tasks, bilinguals also outperformed monolinguals in certain tasks. Furthermore, being proficient in two or more languages may help suspend the arrival of dementia.

## **Disadvantages of Immersing Children in a Native Language**

### **The Cultural Perspective**

Although the cultural benefits are apparent, as presented earlier; still, some studies found some drawbacks of insisting children speak a native language (Costigan & Dokis, 2006; Hwang, Wood & Fujimoto, 2010). This includes that the parent and child may disagree on the value of retaining the language (Costigan & Dokis, 2006; Hwang et al., 2010). Young people may be self-conscious to speak it and fear being judged by people from the host culture (Weyant, 2007). When people from different ethnic cultural backgrounds unite and form a family, they may decide to only teach English to their children. (AhnAllen & Suyemoto, 2011; Hynie, Lalonde, & Lee, 2006; Mok, 1999).

**Differences in values.** Insisting children to speak a native language may cause rift in the family if the child resists doing so. Some young people may not see the value in keeping their native language. Hwang et al. (2010) introduced the term *acculturative family distancing* (AFD). This is the distancing that transpires among immigrant parents and their children; it is triggered by breakdowns in communication and cultural value differences. This may be due to the different degrees with which parents and children obtain characteristics of the host culture at different rates (Berry, 2005). This study indicated that larger numbers of youth and mothers reports of AFD were associated with higher depressive symptoms and risk for clinical depression. Therefore, enforcing the native language to be spoken may cause further distancing between the parent and child.

Furthermore, Costigan and Dokis (2006) relayed that when Chinese Canadian parents were more adamantly in favour of the Chinese culture and desired to speak Chinese, a decreased level of Chinese cultural and linguistic participation by the children was related to instability in the relationship. When parents and children do not assign the same value to learning and speaking Chinese, disagreements may ensue. In the long run, these disagreements may cause the family to be divided.

**Being self-conscious.** Children may not desire to speak a native language due to not wanting to digress from the host culture. The younger generation may feel that speaking a native language may not be the prevalent thing to do. Weyant's (2007) study found that participants favoured people who speak English without an accent. After listening to an audiotape of various speakers with different accents, they rated the pure English speaker higher in areas of ability and accomplishment. Hence, participants thought they were more intelligent than the speakers who spoke with an accent. Young people may pick up on this negative stigma and feel self-conscious about their native language. Therefore, when parents push too hard for them to learn and use the language, they may further resist doing so.

**Interracial relationships.** In unions in which one partner does not speak the language, the couple may choose not to teach their children one of the parent's native languages. This may be due to thinking that a language barrier between one parent and the children may be unfair. A study conducted by AhnAllen and Suyemoto (2011), found that when Asian women and White men date, they experience barriers such as reconciling how to communicate effectively, facing unacceptance by family members, and the weight of having to challenge racism. When marriage becomes a reality, it may be more difficult to navigate whether to teach children a native language, since one partner would not understand the language.

According to Costigan and Dokis' (2006) study mentioned earlier, Chinese women were more likely to teach language. Hence, when a Chinese man marries outside of his ethnic culture, the likelihood of preserving the native language may be lower. However, women may still have the tendency to immerse their children in the language, due to wanting to preserve the culture. In interracial relationships, the dynamics are different since one partner would not speak Chinese (AhnAllen & Suyemoto, 2011). Again, it becomes more challenging to decide whether to teach the Chinese language, out of consideration for the spouse who does not speak or understand it.

Furthermore, Hynie and colleagues (2006) study suggested that Chinese immigrant parents and children may be at odds with one another about their choice of partners. Parents in this study preferred their children to marry someone with traits related to the traditional family construction, function, and role. Subsequently, they wanted their daughters to marry someone with a higher status. Many children in this study aligned with their parent's views, and when this occurred, conflict was absent. In addition, Mok (1999) found that the probability of Asian Americans dating White Americans is partial to higher levels of acculturation rather than lower levels of ethnic identity. One may question, if an individual is more acculturated, then would he or she be less likely to appreciate their native language? Further studies may be needed to address this point. In essence, these studies speak to the conflict that may arise in interracial families when deciding whether or not to introduce, teach, and immerse children in a native language.



In families where the parent speaks a native language, and is diligent in enforcing this spoken language to their children, the children may feel less need to comply, since mainly English is spoken in the host culture. This may cause conflict of interest in the family. Some young people may feel self-conscious when others hear them speak another language; they may feel that they are not blending in with the host culture. In addition, in interracial relationships, one partner may not want to enforce a native language due to not wanting to exclude the other partner.

### **The Cognitive Perspective**

Studies have also shown some cognitive drawbacks to bilingualism. Bilinguals who are more proficient in one language (dominant bilinguals) may lag behind their peers in the performance of lexical tasks (Bialystok et al., 2008; Gollan & Ferreria, 2009); of which will be defined below. When two languages differ in their linguistic structure, students may be more challenged to learn the language of instruction (Kempert et al., 2011; Yeong & Rickard Liow, 2011). The fluency of the chosen spoken language may also suffer (Gollan & Ferreria, 2005).

**Dominant bilingual children and lexical tasks.** Hakuta and Garcia (1989) proclaimed that in the early 1900s, the performance on standardized tests highly disfavoured bilingual children; bilingualism was interpreted as a mental burden that caused inferior levels of intellect. Over a century later, Bialystok and colleagues (2008) also found that bilinguals may fall behind monolinguals in lexical tasks including verbal fluency. These tasks include the Peabody Picture Vocabulary Test (PPVT), Boston naming task, and category fluency task from the verbal task battery. David E. Meyers and Roger Schvaneveldt worked together in the 1970s to determine whether lexical-decision tasks affect reaction times (RT) in cognition. It was found that, “lexical-decision RTs are significantly shorter for words (e.g., butter) immediately preceded by other associated words (e.g., bread)” (David E. Meyers, 2002, p. 833). In Bialystok and colleagues’ study, the subjects who were bilinguals were slower in these lexical-decision tasks compared to the monolinguals. In essence, lexical tasks have shown to be more challenging for bilinguals because both languages are active; this creates the need to attend and select during these tasks, thus decreasing retrieval time.

In fact, Gollan and Ferreira’s (2005) study demonstrated this specific retrieval time. For instance, they indicated that Spanish-English bilinguals, where English was usually the stronger language, named pictures in English at a slower rate than English monolinguals. This may have to do with needing to draw from a bank of two languages, thus, slowing down the retrieval time. Therefore, it is significant to note that dominant bilingual children may spend more time on lexical tasks.

### **Bilingual students may experience difficulty when two languages are dissimilar.**

Kempert and colleagues (2011) conveyed that, when ESL students have a weak understanding of the language taught in school, their academic success will be negatively affected. A six-month longitudinal study by Yeong and Rickard Liow (2011) can attest to this, as they found that children with Mandarin, as their first language, favoured syllable awareness as opposed to phoneme awareness. For instance, in Mandarin, each character forms a word, and knowing each syllable, by memorization, helps in reading, whereas in English, children are encouraged to sound out the letters of the alphabet that form words (phoneme system); these differences are

fundamental to note when teaching Mandarin-speaking students the English language. This aforementioned study incorporated 50 kindergarten participants, whereby English was their first language, and 50 kindergarten participants, whereby Mandarin was their first language. During the first trial, the children were administered the parallel version of the English and Mandarin tasks; subsequently, the second time around, their spelling intricacy scores were computed from a 52-item experimental task. Since English is phoneme-based, this makes it more difficult for the Mandarin speakers to learn to spell in English. This points to the importance of Chinese ESL learners being exposed to aural English in the early years, as opposed to children who have a grasp of language with a comparable linguistic organization, such as Spanish and French. In essence, one may decide to not teach children Mandarin due to this disadvantage during primary school age years.

**The fluency disadvantage.** Gollan and Ferrera (2009) found that bilinguals face the challenge of needing to choose to only speak one language when conversing with monolinguals or multilinguals (with different language combinations), although both languages may be useful to communicate the envisioned meaning. In this study, 73 Spanish-English undergraduate bilinguals contributed for course credit, the goal was to name as many pictures as possible, shown on a computer, without making mistakes. The Spanish group was allowed to name the pictures in Spanish only, the English group, in English only, and there was one group who was allowed to choose the language of choice. Results showed that bilinguals may have a more difficult time when needing to retrieve synonyms. Whereas a monolingual needs to access words for which may not be commonly spoken in everyday language usage, the bilingual has to do so with almost every word they speak because they have to completely eliminate one language when speaking the other. The cost of voluntarily switching from one language to another was substantial in that retrieval time was slower. In this light, bilinguals may have an obvious disadvantage, in terms of fluency, when required to only speak one specific language at a time.

Bilinguals, who are not balanced (more proficient in one language, compared to the other), have a more difficult time completing lexical tasks. Furthermore, when the native language, such as Mandarin, is completely different in syllabic and phonemic organization compared to English, the Mandarin speaker may lag behind in learning English. In addition, bilinguals may fall behind compared to monolinguals in terms of language fluency skills. Despite these drawbacks, in the next section, the reasons for the advantages to overshadow the disadvantages of teaching children a native language will be discussed.

## **Reasons for the Advantages to Outweigh the Disadvantages**

### **The Cultural Perspective**

The literature presented so far, has indicated the various benefits, which are worth the time and care, of teaching children a native language. In this section, the emphasis of the benefits of bringing up a well-rounded bilingual individual (Knafo & Schwartz, 2001; LaFromboise et al., 1993) will be explored. In addition, the strategy of perspective taking may help alleviate the fears of adolescent's becoming embarrassed to speak their native language (Weyant, 2007). Furthermore, the level of communication may prosper when the parent and child both view the importance of preserving the native language (Hwang et al., 2010).



**The bilingual as a whole person.** LaFromboise et al. (1993) found the multicultural model to be a positive representation of one who is bicultural. This model deems that an individual can uphold an affirmative identity as a participant of his or her ethnic culture of origin, while concurrently cultivating a positive identity by engaging and partaking in activities with other cultural groups. In addition, the pressure to resolve internal struggles caused by bicultural stress does not need to result in undesirable psychological impacts, but could, instead, lead to personal and emotional development. Therefore, one may reason that keeping two languages active makes it easier to achieve this growth.

It is important to note that parents who want their children to learn their native language do not negate the importance of learning English. Knafo & Schwartz (2001) found that many immigrant parents want their children to succeed; this includes their encouragement for children to master a host language, and be familiar with the host culture. This could be done simultaneously with speaking the native language at home. Moreover, LaFromboise et al. (1993) suggested that, to successfully meet the demands of the majority culture, one should have the ability to communicate in both cultures. This underscores the significance of keeping the native language alongside learning English.

**Perspective-taking.** Furthermore, Weyant (2007) tested a hypothesis of whether a technique called perspective-taking would help reduce the negative stigma associated with perceiving people who speak English with an accent. He found when participants took the speaker's perspective, when listening to an audio tape, he or she rated the speaker more favourably even when an accent was present. In the absence of this technique, many rated the speaker as less intelligent than that of the native English speaker. Since Canada is a multicultural society, people are exposed to different cultural groups on a daily basis; some may appreciate this technique to fully acknowledge the diversity of our country. When adolescents are taught to take on the perspective of others, prejudice and discrimination, are likely to decrease.

**The united family.** In 2010, Hwang and colleagues found that programs that target the improvement of parent-child communication barriers may help decrease family struggle. When adolescents take the initiative to learn more about their ethnic culture, family conflict was likely to decrease. Moreover, when a spouse in an interracial marriage teaches children Chinese, it provides a greater opportunity for the other spouse to learn a new language. As Rodriguez-Fornells et al. (2006) indicated, language acquisition is possible across the lifespan. From the lens of the cultural perspective, these benefits derived from teaching children a native language are immense. The literature indicates that the family is more united and young people profit from speaking the native language, as well as learning English.

### **The Cognitive Perspective**

The cognitive benefits also outweigh its drawbacks. When children learn two languages, simultaneously at a young age, their brains become more flexible (Adesope et al, 2010). The benefits are well-established, even for those students from a lower SES (Kempert et al., 2010).

**The critical period.** Adesope et al. (2010) indicated bilinguals who learn a second language, at an earlier age, have greater metacognitive and metalinguistic traits than those who learn it at a

later age. In addition, bilinguals fared better than monolinguals in both domains. This points to the significance of immersing children in a native language, from a young age. Children are more prone to learn the language because they feel that it is natural to speak it. When they get older, they may be more self-conscious about speaking a new language.

**Cognitive rewards.** In several studies (Hakuta & Garcia, 1989; Kempert et al., 2011), the authors discussed the drawbacks of being bilingual, however, in these same studies, the conclusion communicated that the benefits outweighed the costs of teaching children a native language. For example, in Kempert and colleagues' study, the summary section communicated that the, "cognitive advantages of speaking two languages may compensate for some of the disadvantages that occur with lower skills in instructional language as well as with low SES" (p. 551). In other words, with the advantages indicated in the above section, it is worth the time to teach children a native language, since it also benefits this group regardless of the family's SES. In addition, the results indicated that children who speak two languages, and who are immigrants should be considered a resource rather than an encumbrance. This is due to the many cognitive benefits that bilinguals encompass, as indicated earlier. Furthermore, Hakuta and Garcia's literature review concluded that two languages do not contend for mental resources with one another; on the contrary, there are numerous cognitive rewards for bilingualism.

The research shows that language acquisition at a young age removes the barriers associated with learning it later in life. Even when people are in different SES categories, the benefits of knowing two languages is present. Contrary to the belief in previous years, the brain does not compete for resources when speaking two languages. It is apparent, that the cognitive advantages outweigh some of the struggles of learning two languages.

## **Conclusion**

As is presented in this literature review, there are numerous benefits in teaching and immersing children in a native language. Within the cultural perspective, this includes confronting the challenges in different rates of acculturation experienced by the parent and the child. It helps foster a bicultural identity in that both the Asian and Western cultures become important to one's development. The feeling of connection becomes more ingrained when parents and children share a common language that celebrates their tradition. It also works to close the generational gap. From a cognitive perspective, the brains of bilinguals are offered more choice in ways to communicate. Bilinguals, who are proficient in both languages, have shown to fare better in mathematics. They also perform better in executive control tasks compared to monolinguals. With the added benefit of slowing down the onset of dementia, these cognitive advantages may be well desired.

On the other side, the drawbacks are also supported by research. The parent and the child may have different views in what each party values, thus disagreements may ensue. The young person may feel uncomfortable and awkward when speaking the native language in public. In interracial relationships, one partner may not pursue this teaching with the child, due to not wanting to leave out the spouse. In relation to the cognitive framework, students who are less proficient in one language, such as the language of instruction, may fall behind in performing lexical tasks. When the two languages are quite different in syllabic and phonemic structure, students may experience a more difficult time when learning to spell in English. In situations

where the individual is only required to speak one language, it may inhibit the fluency of conversations.

Above all, however, the advantages compensate for the disadvantages. An individual may feel more whole when he or she is able to communicate and connect with both cultures. When individuals learn to be less self-conscious about how society, at large, views their spoken language, there is more room for growth. The family would bond more intricately when the parent and child are able to share more than one language. In the cognitive realm, the child would think it is natural to speak the native language when exposed to it at a young age. In essence, the cognitive rewards are paramount and outweigh the drawbacks in many respects.

One limitation of this literature review is that not all studies are specific to Asian immigrants. In addition to studies specific to Asian families (AhnAllen & Suyemoto, 2011; Boutakidis et al., 2011; Costigan & Dokis, 2006; Hynie et al., 2006; Kim & Omizo, 2006; Mok, 1999; Wu & Chao, 2011, Yeong & Rickard Liow, 2011), in several sections, bilinguals who speak Spanish-English (Gollan & Ferreira, 2009; Rodriguez-Fornells et al., 2006), German-Turkish (Kempert et al., 2011), and Hebrew-Russian (Knafo & Schwartz, 2001), were included. The reason for including these studies pertains to the fact that the bilingual experience and bilingual brain may have similarities. On the other hand, there are also differences such as the language structure of Chinese and English are completely different from one another. Therefore, one may not completely take this review and generalize it to the Asian experience.

In several studies (AhnAllen & Suyemoto, 2011; Gollan & Ferreira, 2009; Hwang et al., 2010; Hynie et al., 2006; Kempert et al., 2011; Yeong & Rickard Liow, 2011; Wu & Chao, 2006), the sample size may not be sufficient to make the findings generalizable. For instance, in Wu and Chao's project, there was a relatively smaller sample size of the Chinese American youths, particularly the first generation group. In addition, this was a questionnaire based on the adolescents' reports and negated to ask the parents for their perspective. In the future, both sides should be attained to gain a better picture of the parent-child relationship. Moreover, further longitudinal studies may benefit in addressing age-related variations.

Future studies need to address some strategies for parents who want to teach, and help their children retain, their native language. In addition, gender differences need to be acknowledged, since there is an assumption that females acquire language at faster rate than males. The learning of differences between genders would help parents foster a positive learning experience for both girls and boys. Furthermore, there lacks research on whether bilingualism benefits children with special needs. One may come to question whether adding another language would support or hinder children's development if they already have learning challenges. In light of these limitations and future directions, this literature review explored and presented numerous advantages of teaching and immersing children in a native language.

## References

- Adesope, O. O., Lavin, T., Thompson, T., & Ungerleider, C. (2010). A systematic review and meta-analysis of the cognitive correlates of bilingualism. *Review of Educational Research, 80*(2), 207–245. doi:10.3102/0034654310368803
- AhnAllen, J. M., & Suyemoto, K. L. (2011). Influence of interracial dating on racial and/or ethnic identities of Asian American women and white European American men. *Asian American Journal of Psychology, 2*(1), 61-75. doi:10.1037/a0023325
- Anonymous, 2002. David E. Meyer: Award for distinguished scientific contributions. (2002). *American Psychologist, 57*(11), 831-834. doi:10.1037/0003-066X.57.11.831
- Arthur, N., Merali, N., Djuraskovic, I. (2010). Facilitating the journey between cultures: Counselling immigrants and refugees. In N. Arthur & S. Collins (Eds.), *Culture-infused counselling* (2nd ed., pp. 285-314). Calgary, Canada: Counselling Concepts.
- Berry, J. W. (2005). Acculturation: Living successfully in two cultures. *International Journal of Intercultural Relations, 29*, 697-712. doi:10.1016/j.ijintrel.2005.07.013
- Bialystok, E., Craik, F., & Luk, G. (2008). Cognitive control and lexical access in younger and older bilinguals. *Journal of Experimental Psychology: Learning, Memory, and Cognition, 34*(4), 859-873. doi:10.1037/0278-7393.34.4.859
- Boutakidis, I. P., Chao, R. K., & Rodríguez, J. L. (2011). The role of adolescents' native language fluency on quality of communication and respect for parents in Chinese and Korean immigrant families. *Asian American Journal of Psychology, 2*(2), 128-139. doi:10.1037/a0023606
- Costigan, C. L., & Dokis, D. P. (2006). Relations between parent–child acculturation differences and adjustment within immigrant Chinese families. *Child Development, 77*(5), 1252–1267. doi: 10.1111/j.1467-8624.2006.00932.x
- Derakshan, N., & Eysenck, M. W. (2009). Anxiety, processing efficiency, and cognitive performance: New developments from attentional control theory. *European Psychologist, 14*(2), 168-176. doi:10.1027/1016-9040.14.2.168
- Gollan, T. H., & Ferreira, V. S. (2009). Should I stay or should I switch? A cost–benefit analysis of voluntary language switching in young and aging bilinguals. *Journal of Experimental Psychology: Learning, Memory, and Cognition, 35*(3), 640-665. doi:10.1037/a0014981
- Hakuta, K., & Garcia, E. E. (1989). Bilingualism and education. *American Psychologist, 44*(2), 374-379. doi:10.1037/0003-066X.44.2.374
- Hughes, C., & Ensor, R. (2007). Executive function and theory of mind: Predictive relations from ages 2 to 4. *Developmental Psychology, 43*(6), 1447-1459. doi:10.1037/0012-1649.43.6.1447
- Hwang, W., Wood, J. J., & Fujimoto, K. (2010). Acculturative family distancing (AFD) and depression in Chinese American families. *Journal of Consulting and Clinical Psychology, 78*(5), 655-667. doi:10.1037/a0020542
- Hynie, M., Lalonde, R. N., & Lee, N. S. (2006). Parent-child value transmission among Chinese immigrants to North America: The case of traditional mate preferences. *Cultural Diversity and Ethnic Minority Psychology, 12*(2), 230-244. doi:10.1037/1099-9809.12.2.230
- Kempert, S., Saalbach, H., & Hardy, I. (2011). Cognitive benefits and costs of bilingualism in elementary school students: The case of mathematical word problems. *Journal of Educational Psychology, 103*(3), 547-561. doi:10.1037/a0023619

- Kim, B. K., & Omizo, M. M. (2006). Behavioral acculturation and enculturation and psychological functioning among Asian American college students. *Cultural Diversity and Ethnic Minority Psychology, 12*(2), 245-258. doi:10.1037/1099-9809.12.2.245
- Knafo, A., & Schwartz, S. H. (2001). Value socialization in families of Israeli-born and Soviet-born adolescents in Israel. *Journal of Cross-Cultural Psychology, 32*(2), 213 – 228. doi:10.1177/0022022101032002008
- LaFromboise, T., Coleman, H. L., & Gerton, J. (1993). Psychological impact of biculturalism: Evidence and theory. *Psychological Bulletin, 114*(3), 395–412. doi:10.1037/0033-2909.114.3.395
- Mechelli, A., Crinion, J. T., Noppeney, U., O'Doherty, J., Ashburner, J., Frackowiak, R. S., et al. (2004, October 14). Structural plasticity in the bilingual brain [Abstract]. *Nature, 431*, 757. doi:10.1038/431757a
- Miller, E. K., & Cohen, J. D. (2001). An integrative theory of prefrontal cortex function. *Annual Review of Neuroscience, 24*(1), 167–202. Retrieved from EBSCOhost.
- Mok, T. A. (1999). Asian American dating: Important factors in partner choice. *Cultural Diversity and Ethnic Minority Psychology, 5*(2), 103-117. doi:10.1037/1099-9809.5.2.103
- Pessoa, L. (2009). How do emotion and motivation direct executive control? *Trends in Cognitive Sciences, 13*(4), 160–166. Retrieved from, <http://0-www.sciencedirect.com.aupac.lib.athabascau.ca/science/journal/13646613/13/4>
- Rodriguez-Fornells, A. A., De Diego Balaguer, R. R., & Münte, T. F. (2006). Executive Control in Bilingual Language Processing. *Language Learning, 56*, 133-190. doi:10.1111/j.1467-9922.2006.00359.x
- Weyant, J. M. (2007). Perspective taking as a means of reducing negative stereotyping of individuals who speak English as a second language. *Journal of Applied Social Psychology, 37*, 703–716. doi: 10.1111/j.1559-1816.2007.00181.x
- Wu, C., & Chao, R. K. (2011). Intergenerational cultural dissonance in parent–adolescent relationships among Chinese and European Americans. *Developmental Psychology, 47*(2), 493-508. doi:10.1037/a0021063
- Yeong, S. M., & Rickard Liow, S. J. (2011). Cognitive–linguistic foundations of early spelling development in bilinguals. *Journal of Educational Psychology, 103*(2), 470-488. doi:10.1037/a0022437



# 2013/2014 upcoming events

## 2013

October 23-27, 2013 - ACE2013 - The Fifth Asian Conference on Education

October 23-27, 2013 - ACETS2013 - The Inaugural Asian Conference on Education, Technology and Society

November 8-10, 2013 - MediAsia2013 - The Fourth Asian Conference on Media & Mass Communication

November 8-10, 2013 - FilmAsia2013 - The Second Asian Conference on Film and Documentary

November 21-24, 2013 - ABMC2013 - The Fourth Asian Business & Management Conference

November 21-24, 2013 - ACPEL2013 - The First Asian Conference on Politics, Economics & Law

## 2014

March 27-30, 2014 - ACP2014 - The Fourth Asian Conference on Psychology and the Behavioral Sciences

March 27-30, 2014 - ACERP2014 - The Fourth Asian Conference on Ethics, Religion and Philosophy

April 3-6, 2014 - ACAH2014 - The Fifth Asian Conference on Arts and Humanities

April 3-6, 2014 - LibrAsia2013 - The Fourth Asian Conference on Literature and Librarianship

April 17-20, 2014 - ACLL2014 - The Fourth Asian Conference on Language Learning

April 17-20, 2014 - ACTC2014 - The Fourth Asian Conference on Technology in the Classroom

May 29 - June 1, 2014 - ACAS2014 - The Fourth Asian Conference on Asian Studies

May 29 - June 1, 2014 - ACCS2014 - The Fourth Asian Conference on Cultural Studies

June 12-15, 2014 - ACSS2014 - The Fifth Asian Conference on the Social Sciences

June 12-15, 2014 - ACSEE2014 - The Fourth Asian Conference on Sustainability, Energy and the Environment

October 28 - November 2, 2014 - ACE2014 - The Sixth Asian Conference on Education

October 28 - November 2, 2014 - ACSET2014 - The Second Asian Conference on Society, Education and Technology

November 13-16, 2014 - MediAsia2014 - The Fifth Asian Conference on Media & Mass Communication

November 13-16, 2014 - FilmAsia2014 - The Third Asian Conference on Film and Documentary

November 20-23, 2014 - ABMC2014 - The Fifth Asian Business & Management Conference

November 20-23, 2014 - ACPEL2014 - The Second Asian Conference on Politics, Economics & Law

## 2013

July 4-7, 2013 - ECSS2013 - The Inaugural European Conference on the Social Sciences

July 4-7, 2013 - ECSEE2013 - The Inaugural European Conference on Sustainability, Energy and the Environment

July 11-14, 2013 - ECE - The Inaugural European Conference on Education

July 11-14, 2013 - ECTC2013 - The Inaugural European Conference on Technology in the Classroom

July 18-21, 2013 - ECAH2013 - The Inaugural European Conference on Arts and Humanities

July 18-21, 2013 - ECLL2013 - The Inaugural European Conference on Language Learning

japan

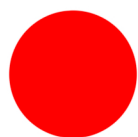

uk



iafor