

# MORSE THEORY ON MANIFOLDS WITH BOUNDARY

PETYA PUSHKAR

ABSTRACT. Main subject of the paper is a (strong) Morse function on a compact manifold with boundary. We generalize classical Morse inequalities.

## INTRODUCTION

*0.1.* Classical Morse theory studies the relationship between the set of critical points of a Morse function on a manifold and the topology of the manifold. In this paper we consider the case of a manifold with boundary. In particular, we solve the problem posed by V.I. Arnold of estimating from below the number of critical points of a generic extension to the whole manifold of a given generic germ of a function along the boundary.

We consider so-called strong Morse functions. Recall that a function  $F$  defined on a compact manifold  $M$  with boundary  $\partial M$  is called a Morse function if

- (1) all of its critical points are non-degenerate and are contained in the interior of  $M$ ;
- (2) the restriction  $F|_{\partial M}$  is Morse function on the closed manifold  $\partial M$ .

Denote by  $\text{Crit}(F)$  the set of all critical points of the function  $F$ . A Morse function  $F$  is called a *strong Morse function* if for any  $x, y \in \text{Crit}(F) \cup \text{Crit}(F|_{\partial M})$  we have  $F(x) \neq F(y)$ . We will refer to a germ of a strong Morse function along the boundary as a *strong Morse germ*.

Let  $F$  be a strong Morse function on  $M$ , and let  $\mathbb{E}$  be a field. The main result of this paper is the existence of powerful combinatorial structure on  $\text{Crit}(F)$ . Part of this structure is the decomposition of  $\text{Crit}(F)$  into two canonical disjoint subsets. We call the first subset the *topologically essential subset* and denote it by  $\text{Top}_{\mathbb{E}}(F)$ . We call the second subset the *additional subset* and denote it by  $\text{Add}_{\mathbb{E}}(F)$ . Accordingly, the Morse polynomial  $P(F)$  of the function  $F$  is decomposed into sum of two polynomials

$$P(F)(t) = \sum_{x \in \text{Crit}(F)} t^{\text{ind } x} = \sum_{x \in \text{Top}_{\mathbb{E}}(F)} t^{\text{ind } x} + \sum_{x \in \text{Add}_{\mathbb{E}}(F)} t^{\text{ind } x},$$

where  $\text{ind}$  denotes the Morse index of a critical point and the first equality is the definition of the Morse polynomial. We denote the first

sum from the right hand side of the equality above by  $P_{\mathbb{E}}(F)(t)$ . We show that the subset  $\text{Add}_{\mathbb{E}}(F)$  decomposes in a canonical way into pairs of critical points of consecutive Morse indices. Thus the second sum from the right hand side of equality above is equal to  $(1+t)K_{\mathbb{E}}(F)(t)$  for a polynomial  $K_{\mathbb{E}}(F)$  with nonnegative integer coefficients.

Let  $f$  be a strong Morse germ along the boundary  $\partial M$  of a manifold  $M$ . We will construct a finite set  $\mathcal{P}_{\mathbb{E}}(f, M)$  of polynomials with nonnegative integer coefficients depending on  $f$ ,  $(M, \partial M)$  and  $\mathbb{E}$  only. The crucial property of  $\mathcal{P}_{\mathbb{E}}(f, M)$  is that for any strong Morse function  $F$  extending the germ  $f$ , the polynomial  $P_{\mathbb{E}}(F)(t)$  belongs to the set  $\mathcal{P}_{\mathbb{E}}(f, M)$ . Thus we have the following theorem:

**Theorem 0.1** (Generalized Morse inequalities). *Suppose that  $f$  is a strong Morse germ. Each strong Morse function  $F: M \rightarrow \mathbb{R}$  extending  $f$  determines a polynomial  $P_{\mathbb{E}}(F) \in \mathcal{P}_{\mathbb{E}}(f, M)$  and a polynomial  $K_{\mathbb{E}}(F)$  with nonnegative integer coefficients so that*

$$P(F)(t) = P_{\mathbb{E}}(F)(t) + (1+t)K_{\mathbb{E}}(F)(t).$$

The set  $\mathcal{P}_{\mathbb{E}}(f, M)$  is explicitly constructed (see Sec. 7.1, 6.1, 6.2 and 6.4) from topological data described in sec. 0.4 below.

Concerning the problem of estimating the number of critical points of an extension of a germ along the boundary we obtain the following theorem, which is a corollary of Theorem 0.1.

**Theorem 0.2.** (Generalized weak Morse estimates) *Suppose  $f$  is a strong Morse germ and let  $F$  be a Morse function extending  $f$ . Then,*

(1) *the number of critical points of the function  $F$  is greater than or equal to  $\min_{P \in \mathcal{P}_{\mathbb{E}}(f, M)} P(1)$ ;*

(2) *the number of critical points of the function  $F$  of index  $i$  is greater than or equal to the minimal coefficient of  $t^i$  among all the coefficients of  $t^i$  of polynomials in the set  $\mathcal{P}_{\mathbb{E}}(f, M)$ .*

*0.2. Relation with the classical Morse inequalities.* We will briefly recall the celebrated Morse inequalities for manifolds with boundary [10]. Consider a germ  $f$  of a function along the boundary of a manifold  $M$ . We say that a critical point of the function  $f|_{\partial M}$  is *outward directed* (respectively, *inward directed*) if the derivative of  $f$  in the direction of the outer normal to the manifold at this point is positive (respectively, negative). For a function  $F$  on  $M$  the outward (respectively, inward) directed critical point of  $F|_{\partial M}$  are defined as those of the germ of  $F$  along  $\partial M$ . We denote the number of critical points of the function  $F$  of index  $i$  by  $m_i(F)$  and the number of inward directed critical points of the function  $F|_{\partial M}$  by  $m_i^{\partial}(F, M)$ .

For any field  $\mathbb{E}$  and Morse function  $F$  the numbers  $M_i = m_i(F) + m_i^{\partial}(F, M)$  and the numbers  $b_i^{\mathbb{E}}(M) = \dim H_i(M; \mathbb{E})$  satisfy the Morse

inequalities [10] for a manifold with boundary

$$(0.1) \quad M_k - M_{k-1} + \dots + (-1)^k M_0 \geq b_k^{\mathbb{E}}(M) - b_{k-1}^{\mathbb{E}}(M) + \dots + (-1)^k b_0^{\mathbb{E}}(M)$$

where  $k \in \{0, \dots, n-1\}$ , as well as

$$M_n - M_{n-1} + \dots + (-1)^n M_0 = b_n^{\mathbb{E}}(M) - b_{n-1}^{\mathbb{E}}(M) + \dots + (-1)^n b_0^{\mathbb{E}}(M).$$

It is known that this system of inequalities is equivalent to the following statement, similar to the statement of Theorem 0.1. Namely, there exists a polynomial  $k_{\mathbb{E}}(F)$  having nonnegative coefficients such that

$$\sum M_i t^i = P_{\mathbb{E}}(M)(t) + (1+t)k_{\mathbb{E}}(F)(t),$$

where  $P_{\mathbb{E}}(M)(t) = \sum b_i^{\mathbb{E}} t^i$  is Poincaré polynomial of the manifold  $M$ . This equality is equivalent to the following equality

$$P(F)(t) = P_{\mathbb{E}}(M)(t) - P_-(F, M)(t) + (1+t)k_{\mathbb{E}}(F)(t),$$

where  $P_-(F, M)(t) = \sum m_i^{\partial}(F, M)t^i$ . Note that the polynomial  $P_{\mathbb{E}}(M)(t) - P_-(F, M)(t)$  depends only on the manifold  $M$  and the germ  $f$  of  $F$  along  $\partial M$ , we will denote  $P_-(F, M)$  by  $P_-(f, M)$ .

We will show (see Sec. 8.1) that, given a strong Morse germ  $f$  and a polynomial  $P \in \mathcal{P}_{\mathbb{E}}(f, M)$  there exists a polynomial  $Q$  with nonnegative integer coefficients such that  $P(t) = P_{\mathbb{E}}(M)(t) - P_-(f, M)(t) + (1+t)Q(t)$ . Thus the classical Morse inequalities are consequences of the Theorem 0.1. For  $M$  closed, we show in Sec. 7.2 that the set  $\mathcal{P}_{\mathbb{E}}(f, M)$  consists of a single element, namely, the Poincaré polynomial  $P_{\mathbb{E}}(M)$  of  $M$ . Hence in the case of closed manifolds Theorem 0.1 is equivalent to the classical Morse inequalities.

*0.3. Simplest example.* For certain important classes of germs the classical Morse inequalities yield adequate estimates for Arnold's problem. More often, however, the estimate derived from classical Morse inequalities are weak or even vacuous.

Consider, for example, the simplest manifold with boundary — a closed interval — and a function  $F$  shown on Fig. 1. Let  $f$  be the germ of  $F$  along the boundary. It is clear that any extension of  $f$  will have at least two critical points. However, the polynomial  $P(f) = P_{\mathbb{E}}(M) - P_-(F, M)$  is equal to zero. Hence, the classical Morse inequalities estimate the number of critical points of a generic extension of  $f$  from below by 0. We show (see Sec. 7.2) that the set  $\mathcal{P}_{\mathbb{E}}(f, M)$  consists of a single polynomial,  $\mathcal{P}_{\mathbb{E}}(f, M) = \{1+t\}$ , which guaranties at least two critical points by Theorem 0.2.

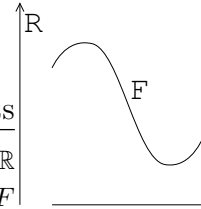

Figure 1.

*0.4. Topological data.* The set  $\mathcal{P}_{\mathbb{E}}(f, M)$  constructed in Sec. 7.1 by an explicit procedure starting from the following data (all the homologies are counted with coefficients in  $\mathbb{E}$ ):

(1) The dimensions of the homologies  $H_k(M)$ ,  $H_k(M, \partial M)$ , and  $H_k(\partial M)$  for any  $k$ .

(2) The critical values, indices and types (inward or outward) of critical points of the function  $f|_{\partial M}$ .

Let  $c_1 < \dots < c_N$  be all the critical values of the function  $f|_{\partial M}$ . We fix a choice of numbers  $a_1, \dots, a_{N+1}$ , such that  $a_1 < c_1 < a_2 < \dots < a_{N+1}$ .

(3) For any pair  $i, j$ , such that  $1 \leq i < j \leq N + 1$ , and for any  $k$  the dimension of the  $k$ -th homology of the pair  $(\{f|_{\partial M} \leq a_j\}, \{f|_{\partial M} \leq a_i\})$ .

(4) For any  $j \in \{1, \dots, N + 1\}$  and nonnegative  $k$  the dimension of the subspace

$$\iota_*(H_k(\{f|_{\partial M} \leq a_i\})) \cap \partial^* H_{k+1}(M, \partial M) \subset H_k(\partial M)$$

is known. The mapping  $\iota_*$  is induced by the natural inclusion  $\{f|_{\partial M} \leq a_i\} \hookrightarrow \partial M$  and  $\partial^*$  is the connecting homomorphism from an exact subsequence of the pair.

The construction of  $\mathcal{P}_{\mathbb{E}}(f, M)$  is independent of the other parts of the paper.

*0.5. Plan of the paper.* In Section 1 we consider an Arnold's example, generalizing example of Sec. 0.3, of a germ of a function along the boundary of  $n$ -dimensional ball and explain methods and techniques of the paper. In Section 2 we correspond to a strong Morse function an algebraic object — a pair of chain complexes with a preferred basis. This pair is defined up to some equivalence.???

*0.6. Previous results.* The problem of finding the condition under which a germ of a function along the boundary can be extended into the interior without critical points was considered in [5] and [6].

The Arnold's problem for a closed  $n$ -dimensional ball was considered by Barannikov [2]. In this case the results of [2] imply estimates which coincide with ours.

BLAGODARNOSTI????

## 1. ON RESULTS AND TECHNIQUES OF THE PAPER

*1.1. Arnold's problem and classical Morse inequalities.* One can show that the algebraic number of critical points of a generic extension of a strong Morse germ  $f$  to  $M$  is independent of the extension and equals to  $\chi(M) - \sum_i (-1)^i m_i(f)$ , where  $m_i(f)$  is the number of inward directed critical points of  $f|_{\partial M}$  of index  $i$ . Denote the number  $\chi(M) - \sum_i (-1)^i m_i(f)$  by  $\chi(M, f)$ . The absolute value of  $\chi(M, f)$  gives a rough estimate for Arnold's problem. This estimate could be deduced from the classical Morse inequalities which give, in general, a stronger estimate in Arnold's problem. We also note here, that Arnold's question of estimation of a number of critical points from below is vacuous without boundary conditions. Indeed, for a connected compact manifold  $M$  of the dimension  $n > 1$ , such that  $\partial M \neq \emptyset$ , and

any collection  $m_0, \dots, m_n$  of non-negative integers can construct a strong Morse function  $F$  on  $M$  such that  $m_i(F) = m_i$ .

The example considered in 0.3 is a particular case of more general construction due to Arnold. For a given constant  $C$  and  $n > 1$  the construction produces a germ  $h$  along the sphere  $S^n$  bounding the closed ball  $B = B^{n+1}$  such that  $\chi(B, h) = 0$  and the number of critical points of a generic extension of  $h$  to the ball bounded is at least  $C$ . The construction starts from an auxiliary closed connected manifold  $N$  of dimension  $n + 1$  such that  $\sum b_i^{\mathbb{E}}(N) \geq C$  and  $\chi(N) = 0$  and a function  $H$  on  $N$  having a finite number of critical points. Consider an embedding  $e: B \hookrightarrow N$  such that all the critical points of  $H$  are contained in the interior of the image of the embedding. Denote by  $h$  the germ of  $e^*H$  along the sphere  $S^n$ . After a slight perturbation of  $e$  we can assume that  $h$  is a strong Morse germ.

The germ  $h$  has the desired properties. Indeed, let  $F$  be a generic extension of  $h$  to  $B$ . Let  $G$  denote the function on  $N$  uniquely determined by  $G|_{N \setminus e(B)} = H$  and  $G \circ e = F$ . The function  $G$  is a Morse function, hence, by Morse theory the number of critical points of  $G$  is at least  $\sum b_i^{\mathbb{E}}(N) (\geq C)$ . By construction, all the critical points of  $G$  are contained in the interior of  $e(B)$ . Therefore, the number of critical points of  $F$  is equal to the number of critical points of  $G$ . The number  $\chi(B, h)$  is equal to the algebraic number of critical points of  $G$ , which equals to  $\chi(N) (= 0)$  by Morse theory.

We show (see Sec. 8.3) that, if  $N$  is a product of a closed manifold with a circle, the classical Morse inequalities do not guarantee existence of critical points of a generic extension of  $h$  to the ball. At the same time our inequalities estimate the number of critical points from below by the sum of Betti numbers of the manifold  $N$ .

*1.2. Pairs of complexes.* The construction of the set  $\mathcal{P}_{\mathbb{E}}(M, f)$  is a byproduct of study of pairs of chain complexes of vector spaces over  $\mathbb{E}$  equipped with additional structure. A pair of chain complexes arises in the following way. Using Morse theory one associates to each strong Morse function  $F$  on  $M$  (see ??? below) a pair  $(X, Y)$  of  $CW$ -complexes which is homotopy equivalent to the pair  $(M, \partial M)$ . We note here, that the pair  $(X, Y)$  is not uniquely defined in general, it depends on choices of cell approximation in the construction. It turns out that cells contained in  $Y$  are in one-to-one correspondence with the critical points of  $F|_{\partial M}$ . Cells of  $X$  which are not contained in  $Y$  are in one-to-one correspondence with the union of the set of critical points of the function  $F$  with the set of outward directed critical points of the function  $F|_{\partial M}$ . It turns out that there is a natural order on all cells of  $X$ , such that cellular boundary of each cell is a linear combination of cells of lower order or zero.

Consider the pair of cellular chain complexes with coefficients in  $\mathbb{E}$  of the pair  $(X, Y)$ . This pair is a pair of graded vector spaces  $(L_1, L_2)$  with

the differential  $\partial$ . The pair  $(L_1, L_2)$  is independent of  $(X, Y)$  and has a preferred ordered basis which depends only on the function  $F$ . The differential  $\partial$ , in general, depends on the pair  $(X, Y)$ . The value of  $\partial$  on a basis element is either a linear combination of basis elements having lower order or zero. We say that such a differential is a  $M$ -differential.

The arbitrariness in a choice of  $(X, Y)$  leads to an arbitrariness of  $M$ -differentials. We refer to an upper triangular group a group of all graded automorphisms of  $L_1$  preserving  $L_2$  with upper triangular matrices in the preferred basis. Upper triangular group acts on  $M$ -differentials by conjugation.

Let  $\partial, \partial_1$  be two  $M$ -differentials on  $(L_1, L_2)$  given by Morse theory. We show (see ???) that there exists upper triangular automorphism  $S$ , such that  $\partial = S^{-1}\partial_1 S$ .

*1.3. Partition of  $M$ -differentials.* By the consideration above, each strong Morse function  $F$  corresponds to an orbit  $O_F$  of the action of upper triangular group on the space of  $M$ -differentials.

We consider the space of all  $M$ -differentials acting on a pair of graded vector spaces equipped with an ordered basis and the action by conjugation of upper triangular group on this space. Additional conditions motivated by topological reasons determine a subspace  $\mathcal{D}$  of the space of all  $M$ -differentials which is invariant under the action of upper triangular group. Our main result (see ???) is a partition of the set of orbits of this action on  $\mathcal{D}$  into a finite number of subsets. We show that each set in the resulting partition has a canonical representative which decomposes into a direct sum of differentials of sixteen different types.

Thus, it turns out that there is a remarkable combinatorial structure on the set  $\text{Crit}(F) \cup \text{Crit}(F|_{\partial M})$ : the critical points of the function and its restriction to the boundary can naturally be divided into sets (consisting of one, two, three, and four elements) of the sixteen different types. This combinatorial structure is a generalization to the case of a manifold with boundary of the division of the critical points of a strong Morse function on a closed manifold into pairs and points “responsible for homologies”. In particular, this combinatorial structure gives rise the partition  $\text{Crit}(F) = \text{Top}_{\mathbb{E}}(F) \cup \text{Add}_{\mathbb{E}}(F)$  mentioned in sec. 0.1.

In addition, to an orbit  $O$  of the action of upper triangular group on  $\mathcal{D}$  we associate a finite graph  $\Gamma(O)$ . Let  $f$  be a strong Morse germ along the boundary  $\partial M$  of a manifold  $M$  and let  $F$  is a strong Morse function on  $M$  extending the germ  $f$ . We show that the graph  $\Gamma(O_F)$  depends only on the manifold  $M$  and the germ  $f$ ,  $\Gamma(O_F) = \Gamma_{\mathbb{E}}(M, f)$ . The topological data needed for construction of  $\Gamma_{\mathbb{E}}(M, f)$  is described below???

??? Skazat' (snova - proverit' snova li eto) chto mnogohleny stroqtsq po grafu

Denote the number of vertices of the graph  $\Gamma$  by  $v(\Gamma)$ . Recall that a matching is a collection of edges without common vertices. Let  $m(\Gamma)$  equals two times the maximal number of edges in a matching.

We show that the number  $\min_{P \in \mathcal{P}_{\mathbb{E}}(M, f)} P(1)$  from Theorem 0.2 has the following interpretation in terms of  $\Gamma_{\mathbb{E}}(M, f)$ .

**Theorem 1.1.** *The number of critical points of a Morse function continuing a strong Morse germ  $f$  is greater then or equal to*

$$v(\Gamma_{\mathbb{E}}(M, f)) - m(\Gamma_{\mathbb{E}}(M, f)) = \min_{P \in \mathcal{P}_{\mathbb{E}}(M, f)} P(1).$$

The set of vertexes of  $\Gamma_{\mathbb{E}}(M, f)$  are, by definition, graded by integers. A  $k$ -th component of the set of vertexes of  $\Gamma_{\mathbb{E}}(M, f)$  is, by construction, the disjoint union of five sets  $A_k, B_k, C_k, D_k$  and  $E_k$ . The following theorem generalize (in terms of  $\Gamma_{\mathbb{E}}(M, f)$ ) weak Morse inequalities  $m_k(F) \geq b_k^{\mathbb{E}}(M) - m_k(f, \partial M)$  ( $m_k(f, \partial M)$  is the number of index  $k$  inward critical points of  $f$ ).

**Theorem 1.2.** *The number  $m_i(F)$  of critical points of index  $k$  of a Morse function continuing a strong Morse germ  $f$  is greater then or equal to*

$$\#B_k + \#C_k + \#D_k + \#E_k - \#A_{k-1}.$$

## 2. FUNCTIONS ON MANIFOLDS WITH BOUNDARY AND PAIRS OF COMPLEXES

The standard procedure of Morse theory [7] associates a  $CW$ -complex to a Morse function on a closed manifold. Starting from a strong Morse function on a manifold  $M$  with the boundary  $\partial M$  we construct a pair  $(X, Y)$  of  $CW$ -complexes which is homotopy equivalent to the pair  $(M, \partial M)$ . In general, the pair  $(X, Y)$  is not defined uniquely. It depends on cellular approximations used in the construction below. We study (at the level of cellular differential) the arbitrariness in our construction.

*2.1. Bifurcations of sublevel sets.* Let  $F$  be a strong Morse function on a manifold  $M$  with the boundary  $\partial M$ . We denote a sublevel set  $\{F \leq c\}$  by  $F_c$ , and the set  $\{F|_{\partial M} \leq c\}$  by  $F_c^{\partial}$ . Let  $c_1 < \dots < c_N$  be critical values of the functions  $F$  and  $F|_{\partial M}$ . For a topological space  $X$  and a continuous map  $\varphi: S^{k-1} \rightarrow X$  we denote by  $X \cup_{\varphi} e^k$  the result of attaching a cell  $e^k$  of the dimension  $k$  along  $\varphi$  to the topological space  $X$ . Recall that a pair of topological spaces  $(A, B)$  is a strong deformation retract of the pair  $(A_1, B_1)$ , if  $(A_1, B_1) \supset (A, B)$  and there exists a family  $f_{t, t \in [0, 1]}: A_1 \rightarrow A_1$  of continuous maps such that  $f_0 = Id$ ,  $f_t(B_1) \subset B_1$ ,  $f_t|_A = Id$  for any  $t \in [0, 1]$  and  $f_1(A_1) = A$ ,  $f_1(B_1) = B$ .

The topology of pair  $(F_c, F_c^{\partial})$  changes when the parameter  $c$  goes through critical values as follows:

**Proposition 2.1.** (0) *If an interval  $[a, b]$  does not contain critical values  $c_1, \dots, c_N$ , then the pair  $(F_a, F_a^\partial)$  is strong deformation retract of the pair  $(F_b, F_b^\partial)$ .*

*Let  $c \in \{c_1, \dots, c_N\}$  and the number  $\varepsilon > 0$  is sufficiently small. Consider pairs  $(F_{c-\varepsilon}, F_{c-\varepsilon}^\partial) \subset (F_{c-\varepsilon} \cup F_{c+\varepsilon}^\partial, F_{c+\varepsilon}^\partial) \subset (F_{c+\varepsilon}, F_{c+\varepsilon}^\partial)$ .*

(1) *Let  $c$  be a critical value of the function  $F$  at the critical point of index  $k$ . The pair  $(F_{c-\varepsilon}, F_{c-\varepsilon}^\partial)$  is a strong deformation retract of the pair  $(F_{c-\varepsilon} \cup F_{c+\varepsilon}^\partial, F_{c+\varepsilon}^\partial)$ . There exist an attaching map  $\varphi$  and a homotopy equivalence*

$$h: (F_{c+\varepsilon}, F_{c+\varepsilon}^\partial) \rightarrow ((F_{c-\varepsilon} \cup F_{c+\varepsilon}^\partial) \cup_\varphi e^k, F_{c+\varepsilon}^\partial),$$

*which equals to the identity map on  $F_{c-\varepsilon} \cup F_{c+\varepsilon}^\partial$ .*

(2) *Let  $c$  be a critical value of the function  $F|_{\partial M}$  at the inward directed critical point of index  $k$ . There exist an attaching map  $\varphi$  and a homotopy equivalence*

$$h: (F_{c-\varepsilon} \cup F_{c+\varepsilon}^\partial, F_{c+\varepsilon}^\partial) \rightarrow (F_{c-\varepsilon} \cup_\varphi e^k, F_{c-\varepsilon}^\partial \cup_\varphi e^k),$$

*which equals to the identity map on  $F_{c-\varepsilon}$ . The pair  $(F_{c-\varepsilon} \cup F_{c+\varepsilon}^\partial, F_{c+\varepsilon}^\partial)$  is a strong deformation retract of the pair  $(F_{c+\varepsilon}, F_{c+\varepsilon}^\partial)$ .*

(3) *Let  $c$  be a critical value of the function  $F|_{\partial M}$  at the outward directed critical point of index  $k$ . There exist an attaching map  $\varphi$  and a homotopy equivalence*

$$h: (F_{c-\varepsilon} \cup F_{c+\varepsilon}^\partial, F_{c+\varepsilon}^\partial) \rightarrow (F_{c-\varepsilon} \cup_\varphi e^k, F_{c-\varepsilon}^\partial \cup_\varphi e^k),$$

*which equals to the identity map on  $F_{c-\varepsilon}$ . There exist an attaching map  $\varphi_1$  and a homotopy equivalence*

$$h_1: (F_{c+\varepsilon}, F_{c+\varepsilon}^\partial) \rightarrow ((F_{c-\varepsilon} \cup F_{c+\varepsilon}^\partial) \cup_{\varphi_1} e^{k+1}, F_{c+\varepsilon}^\partial),$$

*which equals to the identity map on  $F_{c-\varepsilon} \cup F_{c+\varepsilon}^\partial$ . The space  $F_{c-\varepsilon}$  is a strong deformation retract of the space  $F_{c+\varepsilon}$ .  $\square$*

Proposition 2.1 is a relative version of standard [7] results from Morse theory. Proof is parallel to standard considerations, it follows from the relative version Morse lemma, saying that for each inward (respectively, outward) critical point  $F|_{\partial M}$  with the critical value  $c$  there exist a local coordinates  $(x, y)$  ( $y \in \mathbb{R}_+$ ) centered at the critical point such that  $F(x, y) = c + y + Q(x)$  (respectively,  $F(x, y) = c - y + Q(x)$ ) where  $Q$  is a ‘‘sum of squares’’, and from an explicit for that coordinates choice of cells and retractions. We omit the details.

*2.2. Remark.* There exists a surgery on a strong Morse function eliminating its outward (respectively, inward) critical points and does not change a restriction to the boundary. This surgery is local, i.e. defined in a collection of neighbourhoods of critical points of the restriction to the boundary. Two-dimensional examples of such a surgery are shown on 2. Each surgery adds an additional critical point inside the manifold. Surgery eliminating all inward points was used



in [10]. It is easy to obtain the classical Morse inequalities by combining this surgery with the results of part (0),(1) and (3) of Proposition 2.1.

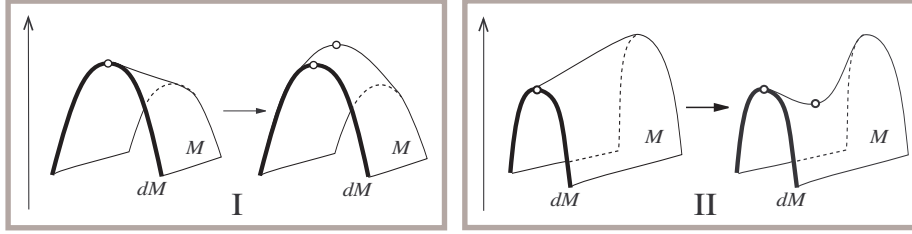

Figure 2. Surgery on a strong Morse function

*2.3. Morse chain.* We continue in the notations introduced in sec. 2.1. The function  $F$  takes its maximal value at the point belongs the set  $\text{Crit}(F) \cup \text{Crit}(F|_{\partial M})$ . Hence, values of the function  $F$  lies in the interval  $[c_1, c_N]$ . We fix numbers  $a_0, \dots, a_N$  such that  $a_0 < c_1 < a_1 < \dots < a_N < c_N < a_N$ . Consider the chain of inclusions of topological spaces:

$$\begin{aligned} (\emptyset, \emptyset) &= (F_{a_0}, F_{a_0}^\partial) \subset (F_{a_0} \cup F_{a_1}^\partial, F_{a_1}^\partial) \subset (F_{a_1}, F_{a_1}^\partial) \subset \dots \\ &\dots \subset (F_{a_{N-1}}, F_{a_{N-1}}^\partial) \subset (F_{a_{N-1}} \cup F_{a_N}^\partial, F_{a_N}^\partial) \subset (F_{a_N}, F_{a_N}^\partial) = (M, \partial M). \end{aligned}$$

There are  $2N + 1$  pairs in the chain, we denote them as  $(U_0, V_0) \subset (U_1, V_1) \subset \dots \subset (U_{2N}, V_{2N})$ .

According to Proposition 2.1 either  $U_{i+1}$  is homotopy equivalent to  $U_i$  or  $U_{i+1}$  is homotopy equivalent to  $U_i$  with a cell attached. Applying standard techniques (see [7]) one can construct a chain of inclusions of pairs of  $CW$ -complexes

$$(\tilde{X}_0, \tilde{Y}_0) \subset (\tilde{X}_1, \tilde{Y}_1) \subset \dots \subset (\tilde{X}_{2N}, \tilde{Y}_{2N})$$

and homotopy equivalences  $\tilde{h}_i: (U_i, V_i) \rightarrow (\tilde{X}_i, \tilde{Y}_i)$  for  $i \in \{0, \dots, 2N\}$  such that the following diagram

$$\begin{array}{ccccccc} (U_0, V_0) & \subset & (U_1, V_1) & \subset & \dots & \subset & (U_{2N}, V_{2N}) \\ \tilde{h}_0 \downarrow & & \tilde{h}_1 \downarrow & & \dots & & \tilde{h}_{2N} \downarrow \\ (\tilde{X}_0, \tilde{Y}_0) & \subset & (\tilde{X}_1, \tilde{Y}_1) & \subset & \dots & \subset & (\tilde{X}_{2N}, \tilde{Y}_{2N}) \end{array}$$

is commutative and satisfies the following: for  $i \in \{0, \dots, 2N - 1\}$   $\tilde{Y}_i = \tilde{Y}_{2N} \cap \tilde{X}_i$  and  $\tilde{X}_{i+1}$  is either equal to  $\tilde{X}_i$  or is the result of attaching of a single cell to  $\tilde{X}_i$ .

We recall standard topological notions. Let  $(A_0, B_0) \subset (A_1, B_1) \subset \dots \subset (A_K, B_K) = (A, B)$  and  $(C_0, D_0) \subset (C_1, D_1) \subset \dots \subset (C_K, D_K) = (C, D)$  be filtered pairs of topological spaces. A filtered (continuous) map is a map of pairs  $h: (A, B) \rightarrow (C, D)$  such that  $h(A_i) \subset C_i$ ,

$h(B_i) \subset D_i$  for any  $i \in \{0, \dots, 2N\}$ . A filtered homotopy between filtered maps  $h_j : (A, B) \rightarrow (C, D)$ ,  $j \in \{0, 1\}$  is a filtered map  $H : (A \times I, B \times I) \rightarrow (C, D)$  such that  $H|_{A \times \{j\}} = h_j$ ,  $j \in \{0, 1\}$ . Two filtered maps  $h_j : (A, B) \rightarrow (C, D)$ ,  $j \in \{0, 1\}$  are called filtered homotopic if there exists a filtered homotopy between them. A filtered map  $h : (A, B) \rightarrow (C, D)$  is a *filtered homotopy equivalence* if there exist a filtered map  $g : (C, D) \rightarrow (A, B)$ , such that mappings  $h \circ g$  and  $g \circ h$  are filtered homotopic to  $Id_A, Id_B$  respectively. It easy to show along the lines of [7] pp. 20–23 that the map  $h_{2N}$  above is a filtered homotopy equivalence.

We say that a *Morse chain*  $\mathbf{M}$  of the function  $F$  is a following triple:

- (1) a *CW*-pair  $(X, Y)$ ;
- (2) a *CW*-filtration  $(\emptyset, \emptyset) = (X_0, Y_0) \subset \dots \subset (X_{2N}, Y_{2N}) = (X, Y)$ , such that for each  $i \in \{0, \dots, 2N - 1\}$   $Y_i = Y_{2N} \cap X_i$  and  $X_i$  is either equal to  $X_{i-1}$  or is the result of attaching a single cell to  $X_i$ ;
- (3) a filtered homotopy equivalence  $h : (M, \partial M) \rightarrow (X, Y)$ .

We will assume below that orientation of cells in Morse chain is somehow fixed.

In general (see sec. 2.5), the complexes  $X_i, Y_i$  from a Morse chain are not uniquely defined. However, for any  $i \in \{0, \dots, 2N\}$  the number of cells of a given dimension in  $X_i, Y_i$  is determined by the function  $F$  only. According to Proposition 2.1 the total number  $T = T(F)$  of cells in the complex  $X_{2N}$  is equal to the sum of the number of outward critical points of the function  $F|_{\partial M}$  and the number of critical points of the function  $F$ . The total number of cells in the complex  $Y_{2N}$  is equal to the number of critical points of the function  $F|_{\partial M}$ .

*2.4. Remark.* Starting from a Morse function and a generic Riemannian metric on a closed manifold one can equip the manifold with a structure of a *CW*-complex (see. [13]). One can do it in the case of a manifold with a boundary also, but we do not use it in the paper. ???

*2.5. Example.* Consider an annulus which is a complement in a sphere  $S^2 \subset \mathbb{R}^3$  to two disks as shown in Fig. 3.I. Let  $F$  be the height function on this annulus. It has one critical point of index 2 with the critical value  $c_7$ ,  $c_1, c_2, c_3, c_5, c_6$  are critical values of  $F|_{\partial M}$  at inward directed critical points,  $c_4$  is the critical value at the outward directed critical point. In Fig. 3.II, Fig. 3.III we shown cells from Morse chains  $\mathbf{M}, \mathbf{M}'$  corresponding to the function.

!!!!???PEREDELAT' risunok podpisat'  $e_1(\mathbf{M}), \dots, e_8(\mathbf{M})$

*2.6. Upper-triangularity.* Consider a Morse chain  $\mathbf{M}$  of a strong Morse function  $F$ . We enumerate the cells of  $\mathbf{M}$  by  $e_1(\mathbf{M}), \dots, e_T(\mathbf{M})$  with respect to their appearance in the subcomplexes  $X_i$  — a cell attached later has a bigger number then a cell attached on earlier step.

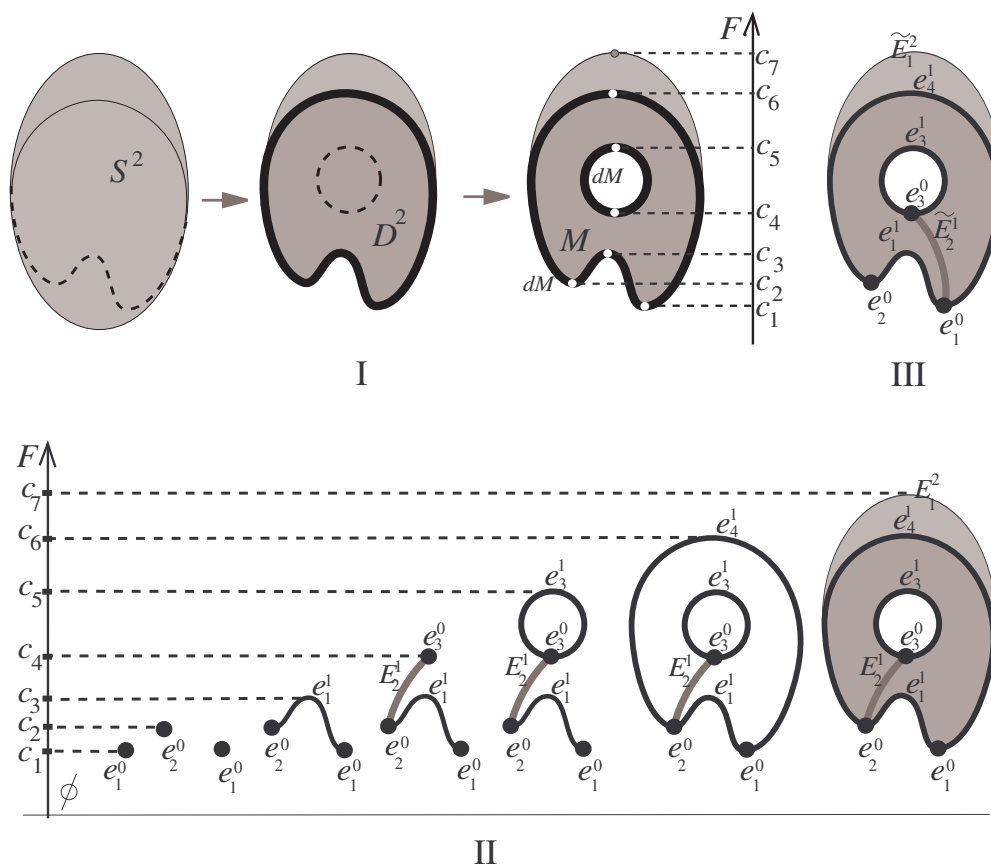

Figure 3. Height function on an annulus

Consider Morse chains  $\mathbf{M}$ ,  $\mathbf{M}'$  of the strong Morse function  $F$ . Let  $\mathbf{M}$  consists of pairs  $\{(X_i, Y_i)\}$  and a filtered homotopy equivalence  $h$ ,  $\mathbf{M}'$  consists of pairs  $\{(X'_i, Y'_i)\}$  and a filtered homotopy equivalence  $h'$ . Consider a filtered homotopy inverse  $g: (X_{2N}, Y_{2N}) \rightarrow (U_{2N}, V_{2N})$  of the filtered map  $h$ . Let  $S$  denote the composition  $h \circ g$ . The map  $S$  induces a cellular homotopy equivalence  $S_i: X_i \rightarrow X'_i$  for any  $i \in \{1, \dots, 2N\}$ . Let  $S_i^\#$  denote the induced map of cellular chain complexes.  $S_{2N}^\#$  is an isomorphism of complexes, moreover, the following statement holds.

**Proposition 2.2.** *Matrix of  $S_{2N}^\#$  with respect to the bases  $(e_1(\mathbf{M}), \dots, e_L(\mathbf{M}))$  and  $(e_1(\mathbf{M}'), \dots, e_L(\mathbf{M}'))$  is upper-triangular with  $\pm 1$  on the diagonal.*

*Proof.* Consider a cell  $e_k(\mathbf{M})$ . Consider the minimal  $i = i(k)$  such that  $e_k(\mathbf{M}) \in X_i$ . By definition  $X_i$  consists of  $k$  cells  $e_1(\mathbf{M}), \dots, e_k(\mathbf{M})$ . The map  $S$  is filtered, hence  $S_{2N}^\#(e_k(\mathbf{M})) = S_i^\#(e_k(\mathbf{M}))$ . The number of cells in  $X'_i$  is equal to the number of cells in  $X_i$ . Therefore,  $S_i^\#(e_k(\mathbf{M}))$

is a linear combination of cells  $e_1(\mathbf{M}'), \dots, e_k(\mathbf{M}')$ . It proves that matrix of  $S_{2N}^\#$  is upper triangular.

A diagonal element  $(S_{2N}^\#)_{k,k}$  is the degree of the map

$$S^{\dim e_k(\mathbf{M})} = X_{i(k)}/X_{i(k)-1} \rightarrow X'_{i(k)}/X'_{i(k)-1} = S^{\dim e_k(\mathbf{M}')}$$

induced from  $S_{i(k)}$ .  $S_{i(k)}$  is a homotopy equivalence. It follows that this degree is equal to  $\pm 1$ .  $\square$

The considerations above motivates the following definitions.

*2.7. Definition of  $M$ -complex, isomorphisms.*  $M$ -complex is a following structure:

- (1) A finite complex of finite-dimensional vector spaces over a field  $\mathbb{E}$ :

$$0 \longrightarrow C_K \xrightarrow{\partial_K} C_{K-1} \xrightarrow{\partial_{K-1}} \dots \xrightarrow{\partial_{L+1}} C_L \xrightarrow{\partial_L} C_{L-1} \longrightarrow 0$$

(i.e. for all  $i$  holds  $\partial_i \circ \partial_{i+1} = 0$ ). We denote direct sum  $\oplus_i \partial_i$  by  $\partial$ .

- (2) Every space  $C_i$  is equipped with a fixed basis.  
(3) On the union  $A$  of all bases fixed linear order, satisfying the “decreasing order” condition: for any  $a \in A$  the vector  $\partial(a)$  is equal to linear combination of elements from  $A$  with order smaller then  $a$  or zero.

We will need also another equivalent definition of  $M$ -complex. Let  $A$  be a finite linearly ordered graded set  $\{a_1, \dots, a_N\}$ ,  $a_1 \prec \dots \prec a_N$ . A grading on  $A$  is a mapping to  $A \rightarrow \mathbb{Z}$ , we denote it by  $\deg$ . The number  $\deg(a)$  is called the *degree* of the element  $a \in A$ . The vector space  $\mathcal{F}(A) = \mathbb{E} \otimes A$  is naturally graded. A  $M$ -differential ( $M_A$ -differential) is a differential  $\partial$  on  $\mathcal{F}(A)$  of degree  $-1$ , such that  $\partial(\mathbb{E} \otimes \{a_1, \dots, a_i\}) \subset \mathbb{E} \otimes \{a_1, \dots, a_{i-1}\}$  for all  $i \in \{1, \dots, N\}$ . An  $M$ -complex is a graded vector space  $\mathcal{F}(A)$  with a  $M$ -differential  $\partial$ . We denote it by  $\mathcal{M}_{A,\partial}$ .  $M$ -complexes equipped with additional structure were considered in [2] and called framed Morse complexes.

We say that two  $M$ -complexes  $\mathcal{M}_{A_1,\partial_1}$  and  $\mathcal{M}_{A_2,\partial_2}$  are equal, if the sets  $A_1$  and  $A_2$  are graded ordered isomorphic and matrices of differentials  $\partial_1$  and  $\partial_2$  in bases  $A_1$  and  $A_2$  coincide. By  $\text{Aut}_T(A)$  we denote a group of all graded automorphisms of the space  $\mathcal{F}(A) = \mathbb{E} \otimes A$ , preserving each vector subspace  $\mathbb{E} \otimes \{a_1, \dots, a_i\}$ ,  $i \in \{1, \dots, N\}$ . Matrices in the basis  $A$  of operators from the group  $\text{Aut}_T(A)$  are upper-triangular. We say that  $M_A$ -differentials  $\partial_1, \partial_2: \mathcal{F}(A) \rightarrow \mathcal{F}(A)$  are equivalent (or  $A$ -equivalent), if there exists such a  $g \in \text{Aut}_T(A)$ , that  $\partial_2 = g\partial_1g^{-1}$ . We say that two  $M$ -complexes are isomorphic, if they are equal after replacing of one  $M$ -differential by an equivalent one.

*2.8. Pairs of  $M$ -complexes.* Let  $\mathcal{M}_{A,\partial}$  be an  $M$ -complex. For such a subset  $B$  of the  $A$ , that  $\partial(\mathbb{E} \otimes B) \subset \mathbb{E} \otimes B = \mathcal{F}(B)$ ,  $\mathcal{M}_{B,\partial|_{\mathcal{F}(B)}}$

is an  $M$ -complex (order and grading on  $B$  are induced from order and grading on  $A$ ). We will say that  $\mathcal{M}_{B, \partial|_{\mathcal{F}(B)}}$  is  $M$ -subcomplex of  $M$ -complex  $\mathcal{M}_{A, \partial}$  and will denote  $\partial|_{\mathcal{F}(B)}$  by  $\partial_B$ . A pair consisting from  $M$ -complex and its  $M$ -subcomplex we call a pair of  $M$ -complexes or  $M$ -pair. Differential  $\partial$  in that case we call  $M_{A, B}$ -differential. We denote an  $M$ -pair  $(\mathcal{M}_{A, \partial}, \mathcal{M}_{B, \partial_B})$  by  $\mathcal{M}_{A, B, \partial}$ . Consider the subgroup  $\text{Aut}_T(A, B)$  of the group  $\text{Aut}_T(A)$ , consisting from all elements  $g \in \text{Aut}_T(A)$ , such that  $g(\mathbb{E} \otimes B) = \mathbb{E} \otimes B$ .  $M_{A, B}$ -differentials  $\partial_1$  and  $\partial_2$  are called  $(A, B)$ -equivalent (or equivalent), if  $\partial_2 = g\partial_1g^{-1}$  for some  $g \in \text{Aut}_T(A, B)$ . Two  $M$ -pairs  $\mathcal{M}_{A_1, B_1, \partial_1}$  and  $\mathcal{M}_{A_2, B_2, \partial_2}$  are called isomorphic, if they are equal after the replacement of one  $M$ -differential on  $(A_1, B_1)$ -equivalent.

*2.9. Algebraic model of strong Morse function.* Let  $F$  be a strong Morse function and  $\mathbf{M}$  be a Morse chain of  $F$ . Cellular boundary of  $e_k(\mathbf{M})$  is zero or linear combination of cells with smaller indexes. Hence, Morse chain naturally generates a pair of  $M$ -complexes  $\mathcal{M}_{A_F, B_F, \partial}$  with  $M$ -differential  $\partial = \partial(\mathbf{M})$ . The set  $B_F$  could be identified with critical points of the function  $F|_{\partial M}$  graded by Morse index  $\text{ind}_M$  and ordered with respect to critical values. The set  $A_F$  is a result of the following operations. Firstly we add to  $B_F$  the set of critical points of function  $F$  graded by  $\text{ind}_M$ . Denote the resulting set by  $C_F$ . It is naturally ordered with respect to critical values. Denote by  $G_F \subset B_F$  a subset consists of all outward critical points of the function  $F|_{\partial M}$ . For each element  $b \in G_F$  we add to  $C_F$  an element  $b_+$  next to  $b$  with degree  $\text{ind}_M F|_{\partial M}(b) + 1$ . The resulting set is  $A_F$ .

The following statement summarizes the previous observations.

**Statement 2.3.** *Strong Morse function  $F$  naturally corresponds to a pair of  $M$ -complexes  $\mathcal{M}_{A_F, B_F, \partial}$ , which is defined up to an isomorphism.  $\square$*

An arbitrary pair of  $M$ -complexes  $\mathcal{M}_{A_F, B_F, \partial}$  isomorphic to an  $M$ -pair constructed by Morse theory from a strong Morse function  $F$  we call an *algebraic model of the function  $F$* . The boundary of 1-cell consists of at most two 0-cells. Hence, even if we consider integer coefficients and isomorphisms only then not every algebraic model corresponds to a Morse chain from sec. 2.3.

*2.10. Boundary homologically essential critical values.* Let  $h$  be a function on the boundary  $\partial M$  of a manifold  $M$ . The set of critical values of the function  $h$  contains naturally distinguished by the following construction subset.

Denote by  $h_c, c \in \mathbb{R}$  the under-level set  $\{h \leq c\}$ . Consider the subspace  $\iota_*(H_*(h_c; \mathbb{E}))$  of the space  $H_*(\partial M; \mathbb{E})$  ( $\iota_*$  is induced by inclusion). Denote by  $I_c$  an intersection of that subspace with a subspace  $\partial^*H_*(M, \partial M; \mathbb{E}) \subset H_*(\partial M; \mathbb{E})$ , where  $\partial^*$  is an operator from

the long exact sequence of a pair  $(M, \partial M)$ . The dimension  $\dim I_c$  is monotone non-decreasing function of the parameter  $c$  with integer values. According to Morse theory the dimension of  $I_c$  jumps only at critical values of the function  $h$ . We say that the critical value of the function  $h$  is boundary essential critical value if it is a point of discontinuity of the function  $\dim I_c$ . Boundary homologically essential critical value of a function  $F$  on  $M$  are those for  $F|_{\partial M}$ .

Boundary homologically essential critical points of a height function are marked by black circles on the Figure 4.

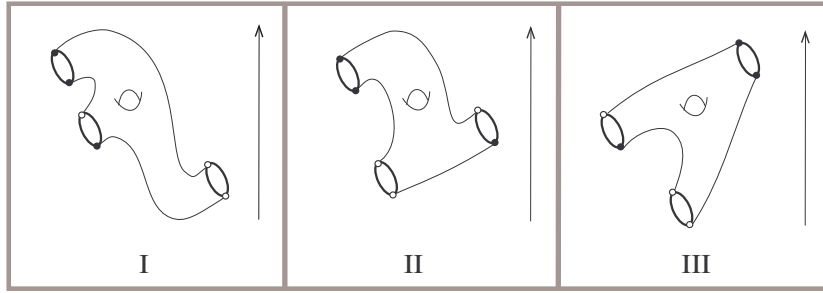
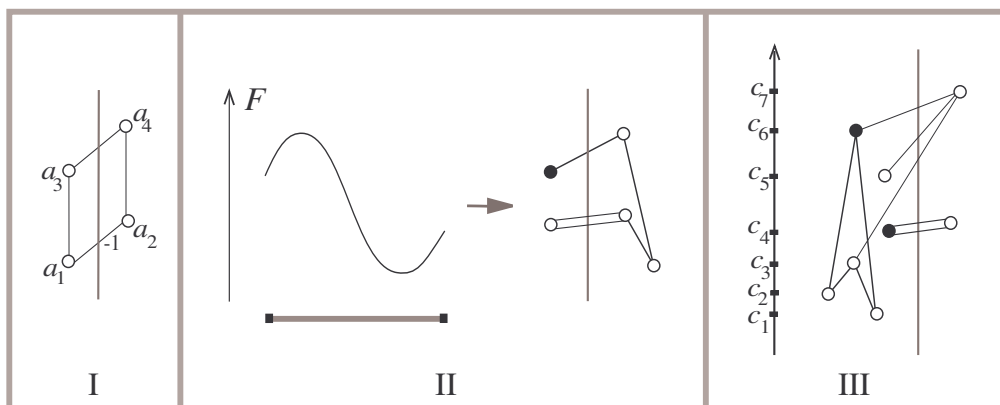

Figure 4. Boundary homologically essential critical values

*2.11. Drawing of a pair of  $M$ -complex.* An  $M$ -pair  $\mathcal{M}_{A,B,\partial}$  we will draw as follows. Elements of the set  $A$  we draw bi circles and place this circles along the vertical axis in correspondence with the order on  $A$ : a circle corresponding to an element  $a_i$  is higher then a circle corresponding to an element  $a_j$  if  $i > j$ . Circles corresponding to elements from the set  $B$  we draw left to the vertical axis, circles corresponding to elements from the set  $A \setminus B$  we draw right to the vertical axis. If  $\partial a_i = \sum_{k \in I} \lambda_k a_k$ ,  $\lambda_k \neq 0$  then we connect circles corresponding to elements  $a_i$  and  $a_k$ ,  $k \in I$  by segments labelled by  $\lambda_k$  if  $\lambda_k \neq 1$ . For example, an  $M$ -pair  $\mathcal{M}_{A,B,\partial}$ , where  $A = \{a_1, a_2, a_3, a_4\}$ ,  $B = \{a_1, a_3\}$ , and differential  $\partial$  defined on basis elements:  $\partial a_4 = a_3 + a_2$ ,  $\partial a_3 = a_1$ ,  $\partial a_2 = -a_1$ ,  $\partial a_1 = 0$  is shown on the Fig. 5.I.

For algebraic model of a strong Morse function  $F$  we draw circles corresponding to boundary critical values of  $F|_{\partial M}$  as black circles. We show below that each outward critical point  $b \in G_F$  appears with non-zero coefficient in  $\partial(b_+)$ . We will draw double segment connecting  $b$  with  $b_+$  instead of ordinary segment. On the Fig. 5.II is shown a graph of a function on a segment and its algebraic model with  $\mathbb{Z}_2$ -coefficients. On the Fig. 5.III we show the  $M$ -pair with  $\mathbb{Z}_2$ -coefficients, which corresponds to the Morse chain from Fig. 3.II.

 Figure 5. Examples of  $M$ -pairs

### 3. PAIR OF $M$ -COMPLEXES. FORMULATION OF $M$ -MODEL THEOREM.

In this section ???

An arbitrary  $M$ -pair, considered up to equivalence, is a difficult object to work with. We will stratify the set of all  $M$ -pairs into pieces such that each stratum contains relatively simple  $M$ -pair encoding the stratum. This  $M$ -pair will be called  $M$ -model of any  $M$ -pair in corresponding stratum.

*3.1. Boundary homologically essential elements of  $M$ -pairs.* The following notion is an algebraic analog of the notion of a boundary homologically essential critical value from 2.10. A filtration on topological space or on a complex defines a filtration on any subspace of its homologies. This simple observation leads us to the following definition. For a finite linearly ordered set  $X = \{x_1 < \dots < x_N\}$  we will denote the space  $\mathbb{E} \otimes \{x_1, \dots, x_k\}$  by  $\mathcal{F}_k(X)$ .

Consider a  $M$ -pair  $\mathcal{M}_{A,B,\partial}$ . Let  $B = \{b_1 < \dots < b_K\}$ . The space  $\mathcal{F}_k(B) = \mathbb{E} \otimes \{b_1, \dots, b_k\} \subset \mathcal{F}(B)$  is  $\partial_B$ -invariant, and hence graded space of homologies  $H_*(\mathcal{F}_k(B), \partial_B)$  is well defined. Let  $\iota_*: H_*(\mathcal{F}_k(B), \partial_B) \rightarrow H_*(\mathcal{F}(B), \partial_B)$  denote the map induced by an inclusion  $\mathcal{F}_k(B) \hookrightarrow \mathcal{F}(B)$ . Let  $\partial_*: H_{*+1}(\mathcal{F}(A), \mathcal{F}(B), \partial) \rightarrow H_*(\mathcal{F}(B), \partial_B)$  be the boundary map of the long exact sequence of the pair  $(\mathcal{F}(A), \mathcal{F}(B))$ . Denote by  $I_k$  an intersection

$$\iota_* H_*(\mathcal{F}_k(B), \partial_B) \cap \partial_* H_*(\mathcal{F}(A), \mathcal{F}(B), \partial) \subset H_*(\mathcal{F}(B), \partial).$$

Basis element  $b_k \in B$  is called  $(\partial)$ -boundary homologically essential, if  $I_k \neq I_{k-1}$  (we let  $I_0 = 0$ ).

We will denote by  $H(\partial)$  the set of all  $\partial$ -boundary essential elements. It is clear that if a  $M$ -differential  $\partial$  is  $(A, B)$ -equivalent to a  $M$ -differential  $\partial'$  then  $H(\partial) = H(\partial')$ .

*3.2.  $\partial$ -trivial elements.* Consider an  $M$ -pair  $\mathcal{M}_{A,B,\partial}$ ,  $A = \{a_1 \prec \dots \prec a_N\}$ . We call an element  $a_k \in B$   $\partial$ -trivial, if  $k < N$ ,  $a_{k+1} \in A \setminus B$  and  $a_k$  appears in the decomposition of  $\partial(a_{k+1})$  with respect to the basis  $A$  with nonzero coefficient.

**Lemma 3.1.** *Let  $\partial$  and  $\partial'$  be  $(A, B)$ -equivalent differentials. The set of all  $\partial$ -trivial elements coincides with the set of all  $\partial'$ -trivial elements.*

*Proof.* Let  $\partial' = g\partial g^{-1}$  for some  $g \in \text{Aut}_T(A, B)$ . We denote by dots linear combination of elements with indexes smaller than  $k$ . We have  $g^{-1}(a_{k+1}) = \lambda_1 a_{k+1} + \dots$ ,  $g(a_k) = \lambda_2 a_k + \dots$  for some  $\lambda_1, \lambda_2 \neq 0$ . Then  $\partial(a_{k+1}) = \mu a_k + \dots$  with  $\mu \neq 0$  implies  $\partial'(a_{k+1}) = \lambda_2 \mu \lambda_1 a_k + \dots$   $\square$

We denote by  $\mathcal{M}_{A,B,G,\partial}$  a  $M$ -pair  $\mathcal{M}_{A,B,\partial}$  with a fixed subset  $G$  of the set of  $\partial$ -trivial elements.

*3.3. Direct sum decomposition.* We say that a  $M$ -pair  $\mathcal{M}_{A,B,\partial}$  is decomposable into the direct sum of two  $M$ -pairs (or, equivalently, that differential  $\partial$  is decomposable into the direct sum), if there exists such a decomposition  $A = A_1 \cup A_2$  into disjoint nonempty subsets, that spaces  $\mathcal{F}(A_1)$  and  $\mathcal{F}(A_2)$  are  $\partial$ -invariant.

In this case spaces  $\mathcal{F}(A_i \cap B)$  are also  $\partial$ -invariant, so  $M$ -pairs  $\mathcal{M}_{A_1,B_1,\partial_1}$  and  $\mathcal{M}_{A_2,B_2,\partial_2}$  are well defined, where  $B_i = A_i \cap B$ ,  $i \in \{1, 2\}$  and  $\partial_i$  are restrictions of  $\partial$ . We will write  $\mathcal{M}_{A,B,\partial} = \mathcal{M}_{A_1,B_1,\partial_1} \oplus \mathcal{M}_{A_2,B_2,\partial_2}$  in this case. If  $\mathcal{M}_{A,B,\partial} = \mathcal{M}_{A_1,B_1,\partial_1} \oplus \mathcal{M}_{A_2,B_2,\partial_2}$  and  $G$  is a subset of all  $\partial$ -trivial elements then, obviously, the set  $G_i = B_i \cap G$  ( $i \in \{1, 2\}$ ) consists of  $\partial_i$ -trivial elements and we write  $\mathcal{M}_{A,B,G,\partial} = \mathcal{M}_{A_1,B_1,G,\partial_1} \oplus \mathcal{M}_{A_2,B_2,G,\partial_2}$  (or  $\partial = \partial_1 \oplus \partial_2$ ) in that case. Decomposition into the direct sum of greater number of summands is defined in a similar fashion.

Decomposition of an  $M$ -pair into the direct sum of indecomposable summands is unique up to a reordering of summands. The following lemma is obvious.

**Lemma 3.2.** *Let  $\mathcal{M}_{A,B,\partial} = \mathcal{M}_{A_1,B_1,\partial_1} \oplus \dots \oplus \mathcal{M}_{A_K,B_K,\partial_K}$ . Then  $H(\partial) = H(\partial_1) \cup \dots \cup H(\partial_K)$  and any  $\partial$ -trivial element  $a \in A_i$  is  $\partial_i$ -trivial element.*  $\square$

*3.4. Set  $\mathcal{D}_{A,B,G}$ ,  $G$ -equivalence.*  $M$ -complexes, considered up to an isomorphism, admit remarkable classification [2] (see also sec. 4.1 below).  $M$ -pairs do not admit such a classification (see sec. ??)???

We fix a triple  $A \supset B \supset G$  of finite sets and suppose that  $A$  is non-empty. The set  $A$  is graded and linearly ordered. Denote by  $\mathcal{D}_{A,B,G}$  the set of all  $(A, B)$ -differentials, such that any element of  $G$  is  $\partial$ -trivial for any  $\partial \in \mathcal{D}_{A,B,G}$ .



We say that two differentials  $\partial, \partial' \in \mathcal{D}_{A,B,G}$  are  $G$ -equivalent, if they satisfy the following conditions:

- (1) There exists a grading preserving automorphism  $S$  of  $\mathcal{F}(A)$  (which is not necessarily upper triangular) such that  $\partial' = S^{-1}\partial S$ ;
- (2) the space  $\mathcal{F}(B)$  is  $S$ -invariant and  $S|_{\mathcal{F}(B)}$  is upper triangular, i.e.  $S|_{\mathcal{F}(B)} \in \text{Aut}_T(B)$ .

*3.5. Weak equivalence.* Let  $(A, B)$  be a pair of finite ordered graded set and  $\partial \in \mathcal{D}_{A,B,G}$ . Let  $B = \{b_1 \prec \dots \prec b_K\}$ ,  $A \setminus B = \{a_1 \prec \dots \prec a_L\}$ . Denote by  $W_B(A)$  the ordered graded set which is equal (as graded sets) to  $A$  with the linear order  $\prec_n$  given by

$$b_1 \prec_n \dots \prec_n b_K \prec_n a_1 \prec_n \dots \prec_n a_L.$$

$M_{A,B}$ -differential  $\partial$  naturally induces the  $M_{W_B(A)}$ -differential  $w_B(\partial)$  which is equal (as ordinary differential) to  $\partial$ . Obviously the map  $\partial \mapsto w_B(\partial)$  preserves equivalence on  $M$ -differentials. We say that differentials  $\partial, \partial_1 \in \mathcal{D}_{A,B,G}$  are *weakly equivalent* if  $w_B(\partial)$  is equivalent to  $w_B(\partial_1)$ .

*3.6. Totally decomposable  $M$ -differentials.* Consider a picture corresponding to a  $M$ -pair with a  $M$ -differential  $\partial \in \mathcal{D}_{A,B,G}$ . Let element  $a = a_k$  belongs to the set  $G$ . To emphasize it we will draw double segment between a circle corresponding to  $a$  and the circle corresponding to the element  $a_+ = a_{k+1}$ . Elements of the set  $H(\partial)$  we draw as black circles. Grading of any  $M$ -pair  $\mathcal{M}_1 - \mathcal{M}_{16}$  shown on Figure 6 is defined uniquely up to a common shift.

We will call  $M$ -pairs of Figure 6 *glyphes*. We say that a  $M$ -differential  $\partial \in \mathcal{D}_{A,B,G}$  is *totally decomposable* if  $\partial$  is a direct sum of glyphes.

*3.7.  $M$ -model Theorem.*

**Theorem 3.3.** ( *$M$ -model Theorem*) *Let  $\partial \in \mathcal{D}_{A,B,G}$ . There exists a  $M$ -differential totally decomposable  $G$ -equivalent to  $\partial$ .*

*Moreover, for any  $M_{A,B}$ -differential  $\partial$  such  $G$ -equivalent differential may be chosen canonically. For each triple  $(A, B, G)$  there is defined a map  $\mathcal{P}_{A,B,G}: \mathcal{D}_{A,B,G} \rightarrow \mathcal{D}_{A,B,G}$  satisfying the following properties:*

- (1)  $\mathcal{P}_{A,B,G}(\partial)$  is totally decomposable;
- (2) for any  $\partial \in \mathcal{D}_{A,B,G}$  the differential  $\mathcal{P}_{A,B,G}(\partial)$  is  $G$ -equivalent to  $\partial$ ;
- (3) if differentials  $\partial, \partial' \in \mathcal{D}_{A,B,G}$  are weakly equivalent then  $\mathcal{P}_{A,B,G}(\partial) = \mathcal{P}(\partial')$ ;
- (4) if  $\partial$  is totally decomposable then  $\mathcal{P}_{A,B,G}(\partial) = \partial$ ;
- (5) if  $\mathcal{M}_{A,B,G,\partial} = \mathcal{M}_{A_1,B_1,G,\partial_1} \oplus \mathcal{M}_{A_2,B_2,G,\partial_2}$  then  $\mathcal{P}_{A,B,G}(\partial) = \mathcal{P}_{A_1,B_1,G_1}(\partial_1) \oplus \mathcal{P}_{A_2,B_2,G_2}(\partial_2)$ .

We say that  $\mathcal{P}(\partial) = \mathcal{P}_{A,B,G}(\partial)$  is the  $M$ -model of the differential  $\partial$ . The map  $\mathcal{P}$  is defined in the proof of the theorem.

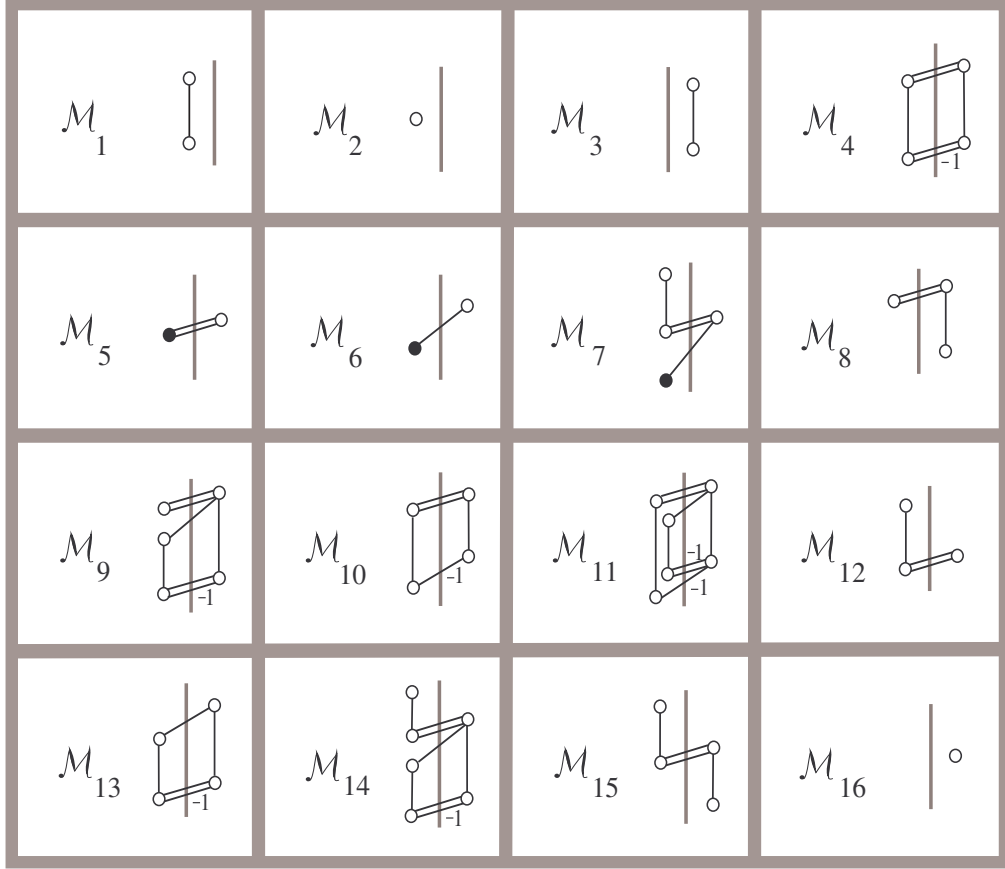

Figure 6. Glyphes

3.8. *Expressions for Poincaré and Morse polynomials.* Consider  $\partial \in \mathcal{D}_{A,B,G}$ . Poincaré polynomials  $P(\mathcal{M}_{A,\partial})(t)$ ,  $P(\mathcal{M}_{A,\partial}, \mathcal{M}_{B,\partial_B})(t)$  are by definition Laurent polynomials  $\sum_k \dim H_k(\mathcal{M}_{A,\partial})t^k$ ,  $\sum_k \dim H_k(\mathcal{M}_{A,\partial}, \mathcal{M}_{B,\partial_B})t^k$  correspondingly.

For an element  $x \in G$  we denote by  $x_+ \in A$  the minimal element in  $A$  bigger than  $x$ . The element  $x_+$  belongs to the set  $A \setminus B$ , denote by  $G_+$  the set of all elements  $x_+$  for  $x \in G$ . We define *Morse polynomial*  $P_M(\partial, G)(t)$  (???? -compare with Introduction!) to be equal  $\sum_{a \in A \setminus (B \cup G_+)} t^{\deg(a)}$ .

We index a glyph by a smallest degree of its basic elements. For a differential  $\partial \in \mathcal{D}_{A,B,G}$  we denote  $\#$  the number of glyphs of given type and index in  $M$ -model for  $\partial$ . In these notations we obtain the following expressions for Poincaré and Morse polynomials.

**Proposition 3.4.**

$$P(\mathcal{M}_{A,\partial})(t) = \sum_k \left( \# \begin{array}{c} \circ \\ | \\ \circ \\ | \\ \circ \end{array} \Big|_{k-1} + \# \begin{array}{c} \circ \\ | \\ \circ \\ | \\ \circ \\ | \\ \circ \end{array} \Big|_{k-1} + \# \circ \Big|_k + \# \Big|_k \circ + \# \begin{array}{c} \circ \\ | \\ \circ \\ | \\ \circ \end{array} \Big|_k \right) t^k,$$

$$P(\mathcal{M}_{A,\partial}, \mathcal{M}_{B,\partial_B})(t) = \sum_k \left( \# \begin{array}{c} \circ \\ | \\ \circ \\ | \\ \circ \end{array} \Big|_{k-1} + \# \begin{array}{c} \circ \\ | \\ \circ \\ | \\ \bullet \end{array} \Big|_{k-1} + \# \begin{array}{c} \circ \\ | \\ \bullet \end{array} \Big|_{k-1} + \# \begin{array}{c} \circ \\ | \\ \bullet \end{array} \Big|_k + \# \Big|_k \circ \right) t^k,$$

$$\begin{aligned} P(\partial, G) = \\ \sum_k \left( \# \begin{array}{c} \circ \\ | \\ \circ \\ | \\ \circ \end{array} \Big|_k + \# \Big|_k \circ + \# \begin{array}{c} \circ \\ | \\ \circ \\ | \\ \circ \end{array} \Big|_k + \# \begin{array}{c} \circ \\ | \\ \circ \\ | \\ \circ \\ | \\ \circ \end{array} \Big|_{k-1} + \# \begin{array}{c} \circ \\ | \\ \bullet \end{array} \Big|_{k-1} + \# \begin{array}{c} \circ \\ | \\ \circ \\ | \\ \circ \end{array} \Big|_{k-2} \right) t^k \\ + \sum_k \left( \# \Big|_k \circ \right) t^k (1+t). \end{aligned}$$

*Proof.* ?????? □

*3.9. Remark.* Notion of weak equivalence,  $G$ -equivalence and  $M$ -model theorem is a product of naive attempts of “simplifying” an  $M$ -differential.

#### 4. ON $M$ -COMPLEXES AND $M$ -PAIRS

This section contains preliminary results needed for the proof of Theorem 3.3. For a given  $M$ -differential we construct an equivalent  $M$ -differential having relatively simple form. We call the differentials of this type by quasi-elementary differentials. This construction is, in fact, the first step in the proof of Theorem 3.3. The proof of Theorem 3.3 involves subsequent simplifications of the constructed quasi-elementary differential.

*4.1. On a structure of  $M$ -complex.* Let  $A$  be a finite linearly ordered graded set. A  $M_A$ -differential  $\partial$  is called an *elementary differential*, if it satisfies the following two conditions:

- (1) for each  $a \in A$  either  $\partial(a) = 0$ , or there exists  $b \in A$ , such that  $\partial(a) = b$ ;
- (2)  $\partial(x) = \partial(y) = z$  and  $x, y, z \in A$  implies  $x = y$ .

**Theorem 4.1.** [2] *Let  $\mathcal{M}_{A,\partial}$  be an  $M$ -complex over a field  $\mathbb{E}$ . Any  $M$ -differential  $\partial$  is equivalent to a unique elementary  $M$ -differential.* □

*4.2. Partition of the basis of a  $M$ -complex into pairs and homologically essential elements.* Consider a  $M$ -complex  $\mathcal{M}_{A,\partial}$ ,  $A = \{a_1 \prec \dots \prec a_N\}$ . Let  $\partial_1$  denote the elementary  $M$ -differential equivalent to  $\partial$  (cf. Theorem 4.1). We say that basis elements  $a_i, a_j$  of an  $M$ -complex  $\mathcal{M}_{A,\partial}$  form a  $\partial$ -pair if  $\partial_1(a_i) = a_j$ . We say that a basis element is  $(\partial)$ -homologically essential element if it does not appear in a  $\partial$ -pair.

According to Theorem 4.1, any element of  $A$  is either a homologically essential element or a member of a unique  $\partial$ -pair. The following assertions describe this combinatorial structure on  $A$  in terms of  $M$ -differential  $\partial$ . We denote by  $\iota$  an inclusion  $\mathcal{F}_j(A) \rightarrow \mathcal{F}(A)$  and by  $\iota_*$  we denote the induced map in homology.

**Lemma 4.2.** (1) *An element  $a_j \in A$  of degree  $l$  is homologically essential, if and only if*

$$\dim \iota_*(H_l(\mathcal{F}_j(A), \partial)) = \dim \iota_*(H_l(\mathcal{F}_{j-1}(A), \partial)) + 1.$$

*The number of homologically essential elements of degree  $k$  is equal to  $\dim H_k(\mathcal{M}_{A,\partial})$*

(2) *An element  $a_i \in A$  is not homologically essential if and only if  $\iota_* H_*(\mathcal{F}_i(A), \partial) = \iota_* H_*(\mathcal{F}_{i-1}(A), \partial)$ .*

(3) *Elements  $a_m, a_n \in A$ ,  $m > n$  form a  $\partial$ -pair if and only if  $\dim H_*(\mathcal{F}_m(A), \mathcal{F}_n(A), \partial) = \dim H_*(\mathcal{F}_{m-1}(A), \mathcal{F}_{n-1}(A), \partial) = \dim H_*(\mathcal{F}_{m-1}(A), \mathcal{F}_n(A), \partial) + 1 = \dim H_*(\mathcal{F}_m(A), \mathcal{F}_{n-1}(A), \partial) + 1$ .*

*Proof.* The statement of lemma is obvious for an elementary differential. Hence, by Theorem 4.1 it holds for any  $M$ -differential, since the dimensions of homologies in the statement depend only on the equivalence class of the  $M$ -differential.  $\square$

*4.3. Homologically essential and boundary homologically essential basis elements.* Consider an  $M$ -pair  $\mathcal{M}_{A,B,\partial}$ . Some elements of the set  $B$  are  $\partial$ -boundary homologically essential elements (see 3.1).

**Lemma 4.3.** *Every  $\partial$ -boundary homologically essential element is  $\partial_B$ -homologically essential. The number of  $\partial$ -boundary homologically essential elements of degree  $k$  is equal to  $\dim \partial_*(H_{k+1}(\mathcal{F}(A), \mathcal{F}(B), \partial))$ .*

*Proof.* According to Lemma 4.2 applied to  $M$ -complex  $\mathcal{M}_{B,\partial_B}$ ,  $\iota_* H_*(\mathcal{F}_l(B), \partial_B) \neq \iota_* H_*(\mathcal{F}_{l-1}(B), \partial_B)$  if and only if  $b_l$  is  $\partial_B$ -homologically essential. For such  $l$  the dimensions of the spaces  $\iota_* H_*(\mathcal{F}_l(B), \partial_B)$  and  $\iota_* H_*(\mathcal{F}_{l-1}(B), \partial_B)$  differ by 1, so we get a full graded flag in  $\iota_* H_*(\mathcal{F}(B), \partial_B)$ , consisting of spaces  $\iota_* H_*(\mathcal{F}_k(B), \partial_B)$ ,  $k \leq l$ . The intersection of a graded subspace with a full flag is a full flag in the subspace. This proves the first claim of Lemma. Spaces  $\iota_* H_*(\mathcal{F}_l(B), \partial_B)$  and  $\partial_*(H_*(\mathcal{F}(A), \mathcal{F}(B), \partial))$  are direct sums of their homogeneous components. This proves the second claim.  $\square$

*4.4. Quotient  $M$ -complexes.* Consider a  $M$ -pair  $\mathcal{M}_{A,B,\partial}$ . We will identify the set  $A \setminus B$  with a basis of quotient complex  $\mathcal{M}_{A,\partial}/\mathcal{M}_{B,\partial_B}$ . The linear order and the grading induce in a natural way the linear order and grading on  $A \setminus B$ . It is clear that the induced differential on  $\mathcal{M}_{A,\partial}/\mathcal{M}_{B,\partial_B}$  is a  $M$ -differential with respect to the linear order and the grading on  $A \setminus B$ . We denote the induced differential by  $\partial_{A \setminus B}$  and

the quotient  $M$ -complex by  $\mathcal{M}_{A \setminus B, \partial_{A \setminus B}}$ . An isomorphism of  $M$ -pairs naturally induces an isomorphism of quotient  $M$ -complexes.

*4.5. The sets  $P, Q, R$  and  $D, E, F$  and bijections.* We will show below that each equivalence class of  $M_{A,B}$ -differential contains a convenient for our goals representative in an equivalence class of  $M_{A,B}$ -differential. To do that we need the following definitions. ??????????

Consider an  $M$ -pair  $\mathcal{M}_{A,B, \partial_0}$ . By Theorem 4.1, the  $M$ -differential  $\partial_0$  of the  $M$ -pair  $\mathcal{M}_{A,B, \partial_0}$  is  $(A, B)$ -equivalent to a  $M$ -differential  $\partial$ , such that  $\partial_B$  and  $\partial_{A \setminus B}$  are elementary  $M$ -differentials.

The differential  $\partial_B$  is elementary, hence, the set  $B$  is decomposed into a disjoint union of subsets  $P, Q, R$  such that  $\partial_B$  restricts to a bijection  $Q \rightarrow R$  and  $\partial_B$  to zero on  $P$ . Similarly, the differential  $\partial_{A \setminus B}$  is elementary, hence, the set  $A \setminus B$  is decomposed into a disjoint union of subsets  $D, E, F$  such that  $\partial_{A \setminus B}$  restricts to a bijection  $E \rightarrow F$  and  $\partial_{A \setminus B}$  to zero on  $D$ .

By Theorem 4.1, the sets  $P, Q, R$  and  $D, E, F$  and bijections  $Q \rightarrow R$  and  $E \rightarrow F$  depend only on equivalence class of the differential  $\partial_0$ .

*4.6. The definition of a quasi-elementary differential.* Consider a vector space  $L$  and a basis  $X$  of  $L$ . We say that  $v = \sum_{x \in X} v_x x \in L$  contains an  $x \in X$  (or  $x$  appears in  $v$ ) if  $v_x \neq 0$ .

We say that differential  $\partial$  is *quasi-elementary* if it satisfies following conditions:

- (1) differentials  $\partial_B$  and  $\partial_{A \setminus B}$  are elementary;
- (2) for each element  $d \in D$  vector  $\partial(d)$  contains at most one element of  $P$ ;
- (3) any element of the set  $P$  appears in at most one vector  $\partial(d)$  for  $d \in D$ .

*4.7. From  $M$ -differentials to quasi-elementary differentials.* Recall that  $H(\partial)$  denotes the set of  $\partial$ -boundary homologically essential elements of a  $M$ -differential  $\partial$  (see 3.1).

**Lemma 4.4.** (1) *Any  $M$ -differential is equivalent to a quasi-elementary  $M$ -differential.*

(2) *Suppose that  $\partial$  is a quasi-elementary  $M$ -differential. The set  $H(\partial)$  coincides with the set of all elements of  $P$  appearing in vectors  $\partial(d)$  for  $d \in D$ .*

(3) *Suppose that  $\partial, \partial_1$  are equivalent quasi-elementary differentials. For any  $d \in D$  and  $p \in P$   $\partial(d)$  contains  $p$ , iff  $\partial_1(d)$  contains  $p$ .*

Note that an equivalence class of  $M$ -differentials may contain more than one quasi-elementary differential. The proof of Lemma 4.4 is given in 4.9 below.

*4.8. The injection  $h_+$ .* Consider an  $M$ -pair  $\mathcal{M}_{A,B, \partial}$ . We define a map  $h_+ : H(\partial) \rightarrow D$  as follows. Let  $\partial'$  be a quasi-elementary differential

equivalent to  $\partial$ . For  $b \in H(\partial)$   $h_+(b)$  is, by definition, an element  $d \in D$  such that  $\partial'(d)$  contains  $b$ . By Lemma 4.4 the map  $h_+$  is defined correctly and depends only on the equivalence class of  $\partial$ . It is clear, that  $h_+$  is an injection. Note, that  $h_+$  increases degree by 1.

The following assertion is immediate corollary of Lemma 4.4.

**Statement 4.5.** *Partition of the set  $B$  into sets  $P, Q, R$ , partition of the set  $A \setminus B$  into sets  $D, E, F$ , bijections  $Q \rightarrow R$  and  $E \rightarrow F$ , subset  $H(\partial_1) \subset P$  and injection  $h_+: H \rightarrow D$  are invariants of an  $M$ -pair  $\mathcal{M}_{A,B,\partial_1}$ .  $\square$*

*4.9. Proof of Lemma 4.4.* We prove the first claim of Lemma. Consider a  $M$ -pair  $\mathcal{M}_{A,B,\partial}$ ,  $A = \{a_1 \prec \dots \prec a_N\}$ .

We assume that differentials  $\partial_B, \partial_{A \setminus B}$  are elementary differentials. If the set  $D$  is empty then the claim is obvious. Suppose now that  $D$  is not empty. Denote its elements by  $d_1 < \dots < d_I$  with respect to the order induced from the order on  $A$ . We will use induction to prove the following statement:  $\partial$  is equivalent to a differential  $\delta = \delta_k$ , having the property that for any  $i \in \{1, \dots, k\}$  vector  $\delta(d_i)$  contains at most one element from  $P$ , each element from  $P$  appears in at most one vector  $\delta(d_j)$  for  $j \in \{1, \dots, k\}$  and  $\partial_B = \delta_B, \partial_{A \setminus B} = \delta_{A \setminus B}$ .

Let  $k = 1$ . Vector  $\partial(d_1)$  may contain only elements from sets  $P, R$  since  $\partial_{A \setminus B}, \partial_B$  are elementary and  $\partial^2(d_1) = 0$ . Hence,  $\partial(d_1) = p + r$ ,  $p \in \mathcal{F}(P), q_1 \in \mathcal{F}(Q), r \in \mathcal{F}(R)$ . If  $p = 0$  then the first step of induction is proved. Consider the case  $p \neq 0$ . Let  $p_i$  be the maximal element of  $P$  which appears in  $p$ . Consider  $T_p \in \text{Aut}_T(A, B)$  such that  $T(p_i) = p$  and all rest basis elements are fixed by  $T_p$ . Then, the differential  $\delta_1 = T_p^{-1} \partial T_p$  has the desired properties. This establishes the base of induction.

Suppose that  $\partial$  is equivalent to  $\delta_k$  as above. We may assume that  $\partial = \delta_k$ . If  $\partial(d_{k+1})$  does not contain elements from  $P$  then  $\delta_{k+1} = \partial$  is the desired differential. Let  $d \in \mathcal{F}(\{d_1, \dots, d_k\})$ . Denote by  $T_d \in \text{Aut}_T(A, B)$  the automorphism which maps  $d_{k+1}$  into a sum  $d_{k+1} + d$  and fixed all rest of basis elements. For every  $d \in \mathcal{F}(\{d_1, \dots, d_k\})$  the differential  $T_d^{-1} \partial T_d$  satisfies the  $k$ -th induction hypothesis and for a suitable  $d_0 \in \mathcal{F}(\{d_1, \dots, d_k\})$  the vector  $T_{d_0}^{-1} \partial T_{d_0}(d_{k+1})$  does not contain elements from  $P$  which appears in  $T_{d_0}^{-1} \partial T_{d_0}(d_i)$  for  $i \in \{1, \dots, k\}$ . So, we may assume that  $\partial(d_{k+1})$  does not contain elements from  $P$  which appear in  $\partial(d_i)$  for  $i \in \{1, \dots, k\}$ . Let  $\partial(d_{k+1}) = p + q$ . Then, the differential  $\delta_{k+1} = T_p^{-1} \partial T_p$  has the desired properties. First claim of Lemma is proved.

Let  $\partial$  be a quasi-elementary differential. Then, the number  $\dim I_k = \dim(\iota_* H_*(\mathcal{F}_k(B), \partial_B) \cap \partial_* H_*(\mathcal{F}(A), \mathcal{F}(B), \partial))$  from the definition of  $\partial$ -boundary homologically essential elements is equal to the number of

elements  $b_i \in \{b_1, \dots, b_k\} \cap P$  appearing in vectors  $\partial(d)$  for  $d \in D$ . It proves the second claim of Lemma.

We are going to prove the third statement. Let  $(A, B)$  be a pair of finite ordered graded set. Let  $B = \{b_1 \prec \dots \prec b_K\}$ ,  $A \setminus B = \{a_1 \prec \dots \prec a_L\}$ . Denote by  $A'$  the ordered graded set which is equal (as graded sets) to  $A$  with the linear order  $\prec_n$  given by

$$b_1 \prec_n \dots \prec_n b_K \prec_n a_1 \prec_n \dots \prec_n a_L.$$

$M_{(A,B)}$ -differential  $d$  naturally induces the  $M_{A'}$ -differential  $\partial'$  which is equal (as ordinary differential) to  $\partial$ . Obviously this map preserves equivalence on  $M$ -differentials.

In view of Theorem 4.1 the third statement follows from the following assertion.

**Lemma 4.6.** *Let  $\partial$  be a quasi-elementary differential. If  $p \in H(\partial)$  appears in  $\partial(d)$  for  $d \in D$  then elements  $d, p$  generates  $\partial'$ -pair.*

*Proof.* It follows from the assumption of Lemma that  $\partial(d) = \lambda p + r$ , where  $\lambda \neq 0$  and  $r \in \mathcal{F}(R)$ . Let  $q \in \mathcal{F}(Q)$  satisfies  $\partial(q) = r$ . It easily follows from  $\partial^2 = 0$  that the element  $p \in H(\partial)$  does not appear in  $\partial(f)$ ,  $f \in F$ . Let  $e_1, \dots, e_k \in E$  be all elements, such that  $p$  appears in  $\partial(e_i)$  with a coefficient  $\lambda_i \neq 0$ . Let  $f_i$  denote  $\partial(e_i)$ . Consider a map  $T$  such that  $T(f_i) = f_i + \lambda_i p$  for  $i \in \{1, \dots, k\}$  and  $T$  fixes all other basis elements. Each  $f_i$  is bigger than  $p$  in the set  $A'$ . Hence,  $T \in \text{Aut}_T(A')$ . The differential  $\partial'_1 = T^{-1}\partial'T$  is  $M_{A'}$ -differential equivalent to  $\partial'$ . The element  $p$  appears in  $\partial'_1(d)$  and does not appear in  $\partial'_1$ -images of other basis elements. Denote by  $T_1$  an automorphism, such that  $T_1(d) = d - q$  and  $T_1$  fixes all other elements. Differential  $\partial'_2 = T_1^{-1}\partial'_1 T_1$  is equivalent to  $\partial'_1$  and the subspace  $\mathcal{F}(\{d, q\})$  is its direct summand.  $\partial'_2(d) = \lambda p$  hence  $d, p$  generates  $\partial'$ -pair.  $\square$

## 5. THE PROOF OF $M$ -MODEL THEOREM

We are proving Theorem 3.3. Let  $\langle \cdot, \cdot \rangle$  denotes standard scalar product on  $\mathcal{F}(A)$ , i.e.,  $\langle a_i, a_j \rangle = \delta_{i,j}$  ( $\delta_{i,j}$  is a Kronecker symbol).

*5.1. Similar  $M$ -pairs and differentials.* We call two  $M$ -pairs  $\mathcal{M}_{A,B,G,\partial}$  and  $\mathcal{M}_{A',B',G',\partial'}$  and differentials  $\partial, \partial'$  *similar* if triples  $(A, B, G)$  and  $(A', B', G')$  are graded ordered isomorphic and  $\langle \partial(a_i), a_j \rangle = 0$  if and only if  $\langle \partial'(a'_i), a'_j \rangle = 0$  for any  $i, j$  (in other words matrices of  $\partial$  and  $\partial'$  have zeroes at same places).

*5.2. Induction.* We will use induction. Suppose that  $\mathcal{P}_{A,B,G}$  is already constructed for all  $A$  such that  $\#A \leq k$  and satisfies the following property: if differentials  $\partial_1$  and  $\partial_2$  are similar quasi-elementary differentials then  $\mathcal{P}_{A,B,G}(\partial_1) = \mathcal{P}_{A,B,G}(\partial_2)$ .

We will denote  $\mathcal{P}_{A,B,G}$  by  $\mathcal{P}_k$ . The base of construction is the case  $\#A = 1$ . For such  $A$   $M$ -differentials are equal to zero ( $M$ -pairs are of

the type  $\mathcal{M}_2$  or  $M_{16}$  only), these differentials are totally decomposable and there is a unique way to define a value of  $\mathcal{P}$  on such differentials:  $\mathcal{P}_{A,B,G}(\partial) = \partial$ .

We will extend  $\mathcal{P}_k$  to  $\mathcal{P}_{k+1}$  satisfying the property mentioned above.

*5.3. From an  $M$ -differential to a minimal differential.* Consider a  $M$ -differential  $\partial \in \mathcal{D}_{A,B,G}$ . According to Lemma 4.4 there exists quasi-elementary differential  $\tilde{\partial}$  equivalent to  $\partial$ . By Lemma 3.1 all elements of the set  $G$  are  $\tilde{\partial}$ -trivial. Thus  $\tilde{\partial} \in \mathcal{D}_{A,B,G}$ . By  $P, Q, R, D, E, F$  and  $h_+$  we denote the sets and the map from Statement 4.5.

We will use the following simple Lemma. We leave the proof to the reader.

**Lemma 5.1.** *Suppose  $\tilde{\partial}$  is a quasi-elementary differential.*

*Let elements  $q \in Q, r \in R, e \in E, f \in F$  satisfy the conditions  $\tilde{\partial}(q) = r, \tilde{\partial}_{A \setminus B}(e) = f$ . Then  $\langle \tilde{\partial}(e), q \rangle = -\langle \tilde{\partial}(f), r \rangle$ .*

*Suppose elements  $e \in E, f \in F$  satisfy the condition  $\tilde{\partial}_{A \setminus B}(e) = f$  and  $x \in B$  appears in  $\tilde{\partial}(f)$ . Then  $x \in R$  and there exists  $q \in R$  such that  $\tilde{\partial}(q) = r$  and  $q$  appears in  $\tilde{\partial}(e)$ .  $\square$*

Recall, that we denote by  $x_+ \in A$  for an element  $x \in G$  the minimal element bigger than  $x$ . The element  $x_+$  belongs to the set  $A \setminus B$ ,  $G_+$  denotes the set of all elements  $x_+$  for  $x \in G$ . We say that elements  $x$  and  $x_+$  generate a  $G$ -pair (or  $(x, x_+)$  is a  $G$ -pair).

Next Lemma describes a (distinguished) subset of non-zero coefficients of the matrix of  $\tilde{\partial}$ .

**Lemma 5.2.** *Suppose that elements  $x \in A \setminus B, y \in B, y \prec x$  satisfy at least one of the following conditions:*

- (1)  $(y, x)$  is a  $G$ -pair;
- (2)  $x = h_+(\partial)(y)$ ;
- (3)  $x \in E, y \in Q$ , and elements  $\tilde{\partial}(y)$  and  $\tilde{\partial}_{A \setminus B}(x)$  generate a  $G$ -pair;
- (4)  $x \in F, y \in R$ , and elements  $q, e$  such that  $\tilde{\partial}(q) = y, \tilde{\partial}_{A \setminus B}(e) = x$  generate a  $G$ -pair.

*then  $\langle \tilde{\partial}(x), y \rangle \neq 0$ .*

*Proof.* If  $(x, y)$  satisfies to the condition (1) or (2) then  $\langle \tilde{\partial}(x), y \rangle \neq 0$  by definition of  $G$  and  $h_+$  correspondingly. If  $(x, y)$  satisfies the condition (3) then by Lemma 5.1  $\langle \tilde{\partial}(x), y \rangle = -\langle \tilde{\partial}(r_+), r \rangle$ . Since  $(r, r_+)$  is a  $G$ -pair we have  $\langle \tilde{\partial}(x), y \rangle \neq 0$ . For condition (4) we have  $\langle \tilde{\partial}(e), q \rangle = -\langle \tilde{\partial}(x), y \rangle$  and  $\langle \tilde{\partial}(x), y \rangle \neq 0$  since  $(q, e)$  is a  $G$ -pair.  $\square$

We say that quasi-elementary differential  $\tilde{\partial}$  is *minimal*, if any pair  $x \in A \setminus B, y \in B, y \prec x$  such that  $\langle \tilde{\partial}(x), y \rangle \neq 0$  satisfies at least one of



conditions of Lemma 5.2. We call the corresponding  $M$ -pair minimal as well.

**Lemma 5.3.** *For every differential  $\partial \in \mathcal{D}_{A,B,G}$  there exists a minimal differential  $\delta \in \mathcal{D}_{A,B,G}$  weakly equivalent to  $\partial$ . All such minimal differentials are similar.*

*If differentials  $\partial, \partial' \in \mathcal{D}_{A,B,G}$  are similar and  $\partial, \partial'$  are weakly equivalent (correspondingly) to minimal differentials  $\delta, \delta'$  then  $\delta, \delta'$  are similar.*

*Proof.* Let  $\partial_1$  be a quasi-elementary differential equivalent to  $\partial$ . We will construct a finite sequence of differentials  $\partial_1, \dots, \partial_m$  such that for any  $x \in A \setminus B, y \in B$   $\langle \partial_{i-1}(x), y \rangle = 0$  implies  $\langle \partial_i(x), y \rangle = 0$  for any  $i \in \{2, \dots, m\}$ , differential  $\partial_i$  is weakly equivalent to  $\partial_{i-1}$  and  $\partial_m = \delta$  is a minimal differential. We proceed by induction. Suppose that  $\partial_i = \rho$  is not a minimal differential and consider a pair  $x \in A \setminus B, y \in B$  such that  $\langle \rho(x), y \rangle \neq 0$  and  $(x, y)$  does not satisfy to any condition (1) – (4) of Lemma 5.2.

**Lemma 5.4.** *The pair  $(x, y)$  satisfies to one of the conditions:*

*N1.  $x \in E, y \in Q$  and each pair  $(y, x), (r, f)$  is not a  $G$ -pair, where  $r = \rho(y), f = \rho_{A \setminus B}(x)$ ;*

*N2.  $x \in E, y \in R$  and  $(y, x)$  is not a  $G$ -pair;*

*N3.  $x \in E, y \in P$  and  $(y, x)$  is not a  $G$ -pair;*

*N4.  $x \in F, y \in R$  and each pair  $(y, x), (q, e)$  is not a  $G$ -pair, where  $q \in Q$  and  $e \in E$  be such elements that  $\rho(q) = y, \rho_{A \setminus B}(e) = x$ ;*

*N5.  $x \in D, y \in R$  and  $(y, x)$  is not a  $G$ -pair.*

*Proof.* Consider the following cases  $x \in E, x \in F$  and  $x \in D$ .

Let  $x \in E$ . If  $y \in Q$  then  $(y, x)$  does not satisfy to conditions (1), (2) and (4) automatically. Since N1 holds, because it contradicts to the condition 3. If  $y \in R$  then  $(y, x)$  does not satisfy to conditions (2), (3) and (4) automatically. Hence N3 holds, because it contradicts to N1. If  $y \in P$  then  $(y, x)$  does not satisfy to conditions (2), (3) and (4) automatically and N3 holds.

Let  $x \in F$ . Then  $y \in R$ , because  $\rho^2 x = 0$  implies  $y \notin Q$  and  $y \notin P$ . The pair  $(y, x)$  does not satisfy to conditions (2) and 3 automatically. Hence it satisfies N4 since it contradicts to conditions (1) and (4).

Let  $x \in D$ . In that case  $y \notin P$  otherwise we have  $x = h_+(y)$ . The equality  $\rho^2 x = 0$  implies  $y \notin Q$ . Hence  $y \in R$  and we get the condition N5.  $\square$

For each case N1-N5 we define a subsequent differential  $\partial_{i+1}$  by the following Lemma.

**Lemma 5.5.** *Let  $\partial_{i+1}$  be a linear operator such that:*

*If  $(x, y)$  satisfies N1 then  $\partial_{i+1}(x) = \rho(x) - \langle \rho(x), y \rangle y$ ,  $\partial_{i+1}(f) = \rho(f) - \langle \rho(f), r \rangle r$ , where  $r = \rho(y), f = \rho_{A \setminus B}(x)$ , and  $\partial_{i+1}$  coincides with  $\rho$  on all other basis elements;*

If  $(x, y)$  satisfies N4 then  $\partial_{i+1}(x) = \rho(x) - \langle \rho(x), y \rangle y$ ,  $\partial_{i+1}(e) = \rho(e) - \langle \rho(e), q \rangle q$ , where  $y = \rho(q)$ ,  $x = \rho_{A \setminus B}(e)$ , and  $\partial_{i+1}$  coincides with  $\rho$  on all other basis elements;

If  $(x, y)$  satisfies either N2 or N3 or N5 then  $\partial_{i+1}(x) = \rho(x) - \langle \rho(x), y \rangle y$  and  $\partial_{i+1}$  coincides with  $\rho$  on all other basis elements;

In each these cases  $\partial_{i+1}$  is quasi-elementary differential,  $\partial_{i+1} \in \mathcal{D}_{A,B,G}$  and  $\partial_{i+1}$  is weakly equivalent to  $\rho$ .

*Proof.* If  $(x, y)$  satisfies N1 then  $\partial_{i+1}$  is equal to  $S_1 \rho S_1^{-1}$  for an automorphism  $S_1$  such that  $S_1(f) = f - \langle \rho(x), y \rangle y$  and  $S_1$  fixes all other basis elements. Thus  $\partial_{i+1}$  is differential ( $\partial_{i+1}^2 = 0$ ). Matrix elements  $\langle \partial_{i+1}(x), y \rangle$  and  $\langle \partial_{i+1}(f), r \rangle$  are equal to zero. Indeed

$$\langle \partial_{i+1}(x), y \rangle = \langle \rho(x) - \langle \rho(x), y \rangle y, y \rangle = \langle \rho(x), y \rangle - \langle \rho(x), y \rangle = 0$$

and

$$\langle \partial_{i+1}(f), r \rangle = \langle \rho(f + \langle \rho(x), y \rangle y), r \rangle = \langle \rho(x), y \rangle + \langle \rho(f), r \rangle = 0.$$

Obviously, all other matrix elements  $\langle \partial_{i+1}(a_m), a_n \rangle$  of  $\partial_{i+1}$  coincides with matrix elements  $\langle \rho(a_m), a_n \rangle$  of  $\rho$ . Hence the differential  $\partial_{i+1}$  belongs to the space  $\mathcal{D}_{A,B,G}$  and it is quasi-elementary differential. Automorphism  $S_1$  belongs to the group  $\text{Aut}_T(W_B(A))$ , hence  $\partial_{i+1}$  is weakly equivalent to  $\rho$ .

Proof for other cases is analogous to the considered one. If  $(x, y)$  satisfies  $N_j$  ( $j \in \{2, 3, 4, 5\}$ ) then  $\partial_{i+1} = S_j \rho S_j^{-1}$ . Operator  $S_4$  acts nontrivially on the element  $x$  only and  $S_4(x) = x + \langle \rho(x), y \rangle q$ . Operators  $S_2$  and  $S_5$  act nontrivially on  $x$  only:  $S_2(x) = S_5(x) = x + \langle \rho(x), y \rangle q$ , where  $\partial_B(q) = y$ . An operator  $S_3$  acts nontrivially only on element  $f = \rho_{A \setminus B}(x)$  and  $S_3(f) = f - \langle \rho(x), y \rangle q$ .

A set of non-zero matrix elements of minimal differential weakly equivalent to  $\partial$  is uniquely defined by sets  $P, Q, R, D, E, F$  and the map  $h_+$ . Hence all minimal differentials weakly equivalent to  $\partial$  are similar.

If differentials are weakly equivalent then sets  $P, Q, R, D, E, F$  and the map  $h_+$  coincide. It proves the second claim of Lemma.  $\square$

Next Lemma describes some properties of minimal differentials.

- Lemma 5.6.** (1) Let  $\partial = \partial_1 \oplus \partial_2$  and let  $\delta_i$  ( $i \in \{1, 2\}$ ) be a minimal differential weakly equivalent to  $\partial_i$ . Then  $\delta_1 \oplus \delta_2$  is minimal differential weakly equivalent to  $\partial$ ;
- (2) Let  $\partial_i \in \mathcal{D}_{A,B,G}$  ( $i \in \{1, 2\}$ ) be similar quasi-elementary differentials and  $\delta_i$  is a minimal differential weakly equivalent to  $\partial_i$ . Then  $\delta_1$  and  $\delta_2$  are similar.

*Proof.* First claim of Lemma is obvious. Second claim holds since sets  $P, Q, R, D, E, F$  and the map  $h_+$  generated by  $\partial_1$  coincide correspondingly with  $P, Q, R, D, E, F$  and the map  $h_+$  generated by  $\partial_2$ .  $\square$

5.4. *Construction of  $\mathcal{P}_{k+1}$ .* Let  $\#A = k + 1$  and  $\partial \in \mathcal{D}_{A,B,G}$ . Let  $\delta$  be a minimal differential weakly equivalent to  $\partial$ . If  $\delta$  is decomposable,  $\delta = \delta_1 \oplus \dots \oplus \delta_n$  is a decomposition into indecomposable summands, then we define  $\mathcal{P}_{k+1}(\partial)$  to be  $\mathcal{P}_k(\delta_1) \oplus \dots \oplus \mathcal{P}_k(\delta_n)$ .

The differential  $\mathcal{P}_{k+1}(\partial)$  is well defined. Indeed, if  $\delta'$  is another minimal differential weakly equivalent to  $\partial$  then  $\delta'$  is similar to  $\delta$ . Hence  $\delta'$  decomposes into indecomposable summands  $\delta'_1, \dots, \delta'_m$  such that  $\delta_i$  is similar to  $\delta'_i$  for any  $i$  by Lemma 5.3. By inductive hypothesis  $\mathcal{P}_k(\delta_i) = \mathcal{P}_k(\delta'_i)$ .

Now we are going to define  $\mathcal{P}_{k+1}$  for  $\partial$  such that a corresponding minimal differential  $\delta$  is indecomposable. We split the construction into two cases. In the first case  $\delta$  satisfies the property: for any  $q \in Q$ ,  $r \in R$  such that  $\delta(q) = r$  and  $q, r \in G$  holds  $\delta_{A \setminus B}(q_+) = r_+$ . The second case is the remaining possibility: there exist elements  $q \in Q$ ,  $r \in R$  such that  $\delta(q) = r$ ,  $q, r \in G$  and  $\delta_{A \setminus B}(q_+) \neq r_+$ .

We say that an  $M$ -pair is  $\mathcal{A}_i$ -glyph ( $i \in \{1, \dots, 4\}$ ) if its differential coincides with differential shown on Fig. 7.

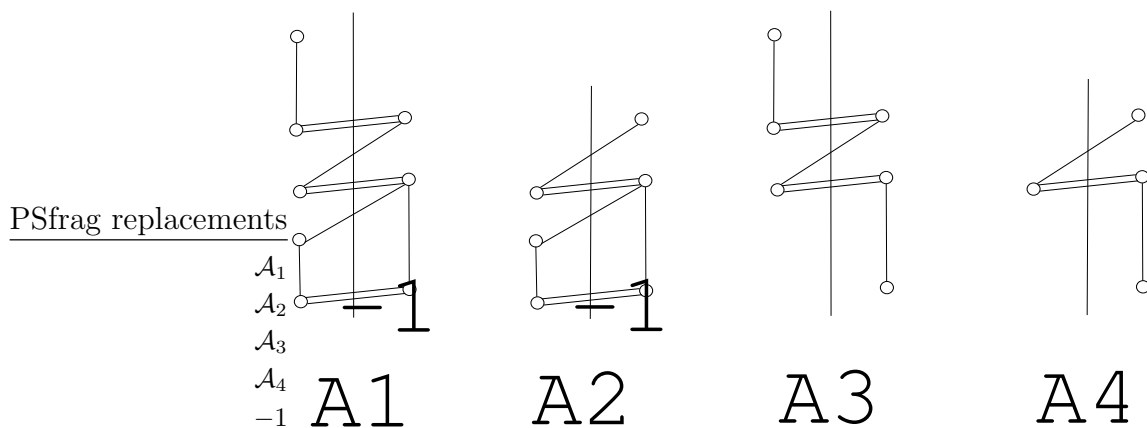

Figure 7. A-glyphes

Let  $\mathcal{M}_\delta = \mathcal{M}_{A,B,G,\delta}$  be an  $M$ -pair and  $\delta$  is a first case indecomposable minimal differential. For example, each  $\mathcal{A}_i$ -glyph or  $\mathcal{M}_i$ -glyph is such a differential. Next Lemma shows that it is only the case.

**Lemma 5.7.** *Differential  $\delta$  is either similar to a glyph or similar to an  $\mathcal{A}$ -glyph.*

Proof of Lemma 5.7 contains in sec. 5.7 below. Let  $\mathcal{M}_{A,B,G,\partial}$  be an  $M$ -pair such that minimal differential  $\delta$  weakly equivalent to  $\partial$  is similar to a differential of a glyph. Then we define  $\mathcal{P}_{k+1}(\partial) = \mathcal{P}_{A,B,G}(\partial)$  to be the differential of that glyph. Obviously,  $\mathcal{P}_{k+1}(\partial) = S\delta S^{-1}$  for a suitable diagonal automorphism  $S$ . Hence,  $\mathcal{P}_{A,B,G}(\partial)$  is  $G$ -equivalent (and even weakly equivalent) to  $\partial$ .

Let  $\mathcal{M}_{A,B,G,\partial}$  be an  $M$ -pair such that minimal differential  $\delta$  weakly equivalent to  $\partial$  is similar to a differential of a  $\mathcal{A}_i$ -glyph. In that case we define  $\mathcal{P}_{A,B,G}(\partial)$  to be a  $M$ -differential shown on the corresponding right part of Fig. 8. Obviously  $\mathcal{P}_{A,B,G}(\partial)$  is well defined. Let us prove that  $\mathcal{P}_{A,B,G}(\partial)$  is  $G$ -equivalent to  $\partial$ . Differential  $\delta$  is equivalent to the corresponding differential of  $\mathcal{A}_i$ , equivalence could be achieved by a suitable diagonal automorphism. It remains to show, that each  $M$ -differential  $\partial_i$  of  $\mathcal{A}_i$ -glyph is  $G$ -equivalent to  $\mathcal{P}(\partial_i)$ . We explicitly present an automorphism  $S_i^{-1}$  making  $G$ -equivalence ( $\mathcal{P}(\partial_i) = S_i \partial_i S_i^{-1}$ ). For  $i \in \{1, 3\}$   $S_i^{-1}$  is automorphism such that  $S_i^{-1}(p_+) = a - q$ ,  $S_i^{-1}(a) = p_+ - a + 2q$  and  $S_i$  fixes all other basis elements (see notations on Fig. 8). For  $i \in \{2, 4\}$   $S_i^{-1}$  is automorphism such that  $S_i^{-1}(p_+) = a - q$ ,  $S_i^{-1}(a) = p_+ - a$  and  $S_i$  fixes all other basis elements.

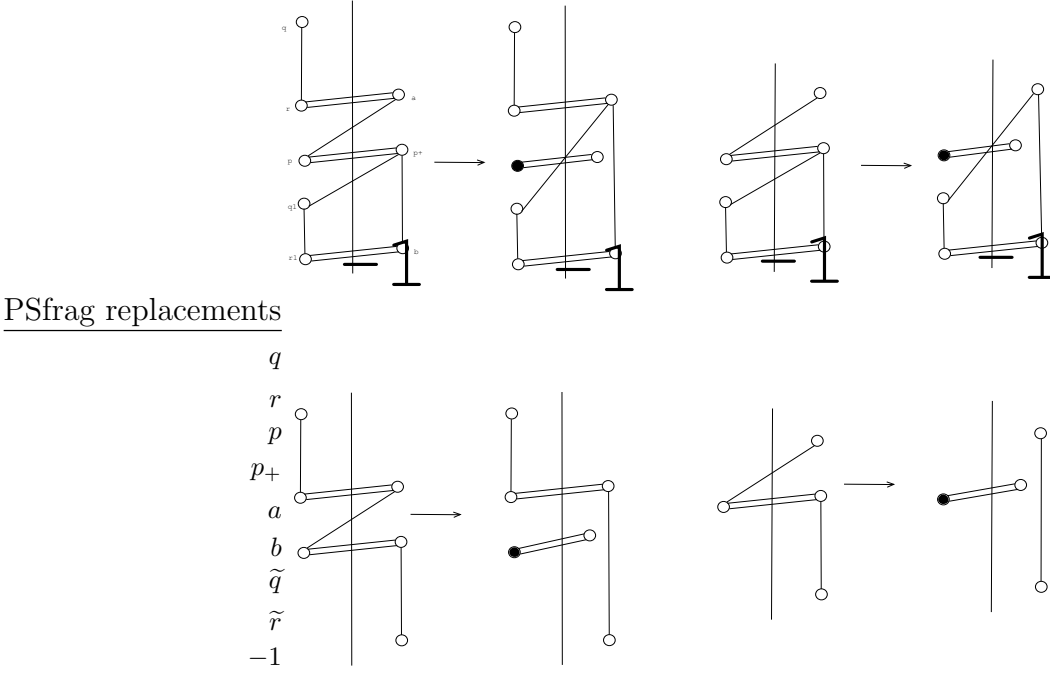

Figure 8. Decompositions

It remains to define  $\mathcal{P}_{k+1}(\partial)$  for differentials  $\partial$  such that minimal differential  $\delta$  weakly equivalent to  $\partial$  is indecomposable and there exist elements  $q \in Q$ ,  $r \in R$  such that  $\delta(q) = r$ ,  $q, r \in G$  and  $\delta_{A \setminus B}(q_+) \neq r_+$ .

Let  $(q_1, p_1), \dots, (q_k, p_k)$  be all such pairs and  $q_1 \prec \dots \prec q_k$ . Consider the pair  $(q, p) = (q_k, p_k)$ .

Denote element  $\delta_{A \setminus B}(q_+)$  by  $n$ . Element  $n$  satisfy inequalities  $r_+ \prec n \prec q$ . Indeed,  $\langle \delta(n), r \rangle = -\langle \delta(q_+), q \rangle \neq 0$  by Lemma 5.1. Hence  $n \prec r$ . Since  $n \neq r_+$  we have  $r_+ \prec n$ . Second inequality  $n \prec q$  holds since  $n = \delta_{A \setminus B}(q_+)$  and  $n \neq q$ .

Consider all the various possibilities for  $n \in G_+$  and  $n \notin G_+$ . Denote by  $\beta$  the number  $\langle \delta(n), r \rangle$ .

Let  $n \in G_+$ . Then  $n = \tilde{r}_+$  for some  $\tilde{r} \in B$ . Since  $\delta^2(q_+) = 0$  it follows that  $\tilde{r} \in R$  and there exists an element  $\tilde{q} \in Q$  such that  $\delta(\tilde{q}) = \tilde{r}$ . Elements  $\tilde{q}, \tilde{r}$  satisfy inequalities  $r_+ \prec \tilde{r} \prec n \prec \tilde{q} \prec q$  (see notations on Fig. 9).

Denote by  $\gamma$  the number  $\langle \delta(n), \tilde{r} \rangle$ . Consider the differential  $\delta'(\delta) = S\delta S^{-1}$ , where

$$S^{-1}(r_+) = n - \gamma\tilde{q}, \quad S^{-1}(n) = r_+ - \alpha q + r\tilde{q}$$

and  $S^{-1}$  fixes all other basis elements.

If  $n \notin G_+$  we define  $\delta'(\delta)$  to be  $S\delta S^{-1}$ , where

$$S^{-1}(r_+) = n, \quad S^{-1}(n) = r_+ - \alpha q$$

and  $S^{-1}$  fixes all other basis elements.

**Lemma 5.8.** *Differential  $\delta'(\delta)$  is a decomposable quasi-elementary differential. If  $\delta_1$  is similar to  $\delta_2$  then  $\delta'(\delta_1)$  is similar to  $\delta'(\delta_2)$ .*

We prove Lemma 5.8 in the sec. 5.8. Since differential  $\delta'(\delta)$  is decomposable  $\mathcal{P}_{k+1}(\delta'(\delta))$  is already defined. We set  $\mathcal{P}_{k+1}(\delta)$  to be equal  $\mathcal{P}_{k+1}(\delta'(\delta))$ . Differential  $\mathcal{P}_{k+1}(\delta)$  is well-defined. Indeed, if  $\delta_1$  is another minimal differential weakly equivalent to  $\delta$ , then  $\delta$  is similar to  $\delta_1$  by Lemma 5.3. By Lemma 5.8 differentials  $\delta'(\delta)$  and  $\delta'(\delta_1)$  are similar. Therefore they decompose into similar quasi-elementary summands. By inductual hypothesis the values of  $\mathcal{P}_k$  coincide on corresponding summands.

The map  $\mathcal{P}_{k+1}$  satisfies the properties (1)-(5) of  $M$ -model Theorem automatically. It remains to show that  $\mathcal{P}_{k+1}$  satisfies the inductual hypothesis. Indeed, consider similar quasi-elementary differentials  $\partial_1$  and  $\partial_2$ . Let  $\delta_1$  ( $\delta_2$ , respectively) be a minimal differential weakly equivalent to  $\partial_1$  ( $\partial_2$ , respectively). By the second part of Lemma 5.3 differentials  $\delta_1, \delta_2$  are similar. Since, by our construction, the value of  $\mathcal{P}_{k+1}$  on minimal differentials depends only on similarity class of minimal differential,  $\mathcal{P}_{k+1}$  satisfies the inductual hypothesis. The proof of  $M$ -model theorem is finished.

*5.5. Minimal complexes.* We are not proving the results of this subsection. In particular these results are helpful to work with Morse functions on manifolds and, also, allows to prove that the map  $\mathcal{P}$  from  $M$ -model Theorem is unique.

Undecomposable minimal complexes admit a simple description. To formulate it we need the following definition. Consider new equivalence relation on  $M$ -pairs: two  $M$ -pairs  $\mathcal{M}_{A,B,G,\partial}$  and  $\mathcal{M}_{A_1,B_1,G_1,\partial_1}$  are equivalent if (1)  $(A_1, B_1, G_1)$  is isomorphic to  $(A, B, G)$  as ordered triples of sets by an (unique) isomorphism  $h: A \rightarrow A_1$ ; (2)  $h^*$  maps

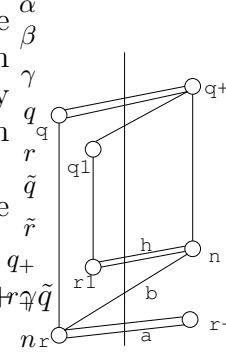

Figure 9.

grading on  $A_1$  into grading on  $A$  shifted by a constant; (3) the induced from  $\partial_1$  differential on  $\mathcal{F}(A)$  is similar to  $\partial$ . We call this equivalence relation similar equivalence. Obviously similar equivalence preserve  $\partial$ -trivial elements.

We draw classes of similar equivalence in similar fashion with pictures  $M$ -pairs: We place a circles corresponding to basis elements with respect to an order along the line (the subset of basis is on the left side), we connect a circles by segment or by double segment if the corresponding matrix elements is non-zero, we place double segment only if it ends in the set  $G$ .

Consider the following partially defined operation on  $M$ -pairs. Consider non-zero  $M$ -pairs  $\mathcal{M}_{A,B,G,\partial}$  and  $\mathcal{M}_{X,Y,Z,\delta}$ , such that  $A \cap X = \emptyset$ . Let  $A = \{a_1 \prec \dots \prec a_K\}$ ,  $X = \{x_1 \prec \dots \prec x_L\}$ . We suppose that degree of  $x_N$  is bigger by one than degree of  $x_N$  and that  $a_1 \notin G$ ,  $x_N \notin Z_+$ . We denote by  $A\#X$  the set  $A \cup X$  with the order  $x_1 \prec \dots \prec x_{L-1} \prec a_1 \prec x_L \prec a_2 \prec \dots \prec a_K$ . We define an linear operator  $\partial\#\delta$  on elements of  $A\#X$  as follows:  $\partial\#\delta(a_i) = \partial(a_i)$  for any  $i \in \{1, \dots, K\}$ ,  $\partial\#\delta(x_i) = \delta(x_i)$  for any  $i \in \{1, \dots, L-1\}$  and  $\partial\#\delta(x_L) = \delta(x_L) + a_1$ . Denote by  $G\#Z$  the set  $G \cup Z \cup \{a_1\}$ . Clearly,  $\partial\#\delta$  is an  $M$ -differential and the set  $G\#Z$  consists of  $\partial\#\delta$ -trivial elements. We denote  $M$ -pair  $\mathcal{M}_{A\#X, B\#Y, G\#Z, \partial\#\delta}$  ( $B\#Y = B \cup Y$ ) as  $\mathcal{M}_{A,B,G,\partial}\#\mathcal{M}_{X,Y,Z,\delta}$ . We set  $\mathcal{M}\#0 = \mathcal{M}$ ,  $0\#\mathcal{M} = \mathcal{M}$  for any  $M$ -pair  $\mathcal{M}$ .

Clearly the operation described above induce the operation on classes of similar equivalence, which we also denote by  $\#$ . Operation  $\#$  is obviously associative.

Consider the following classes of similar equivalence:

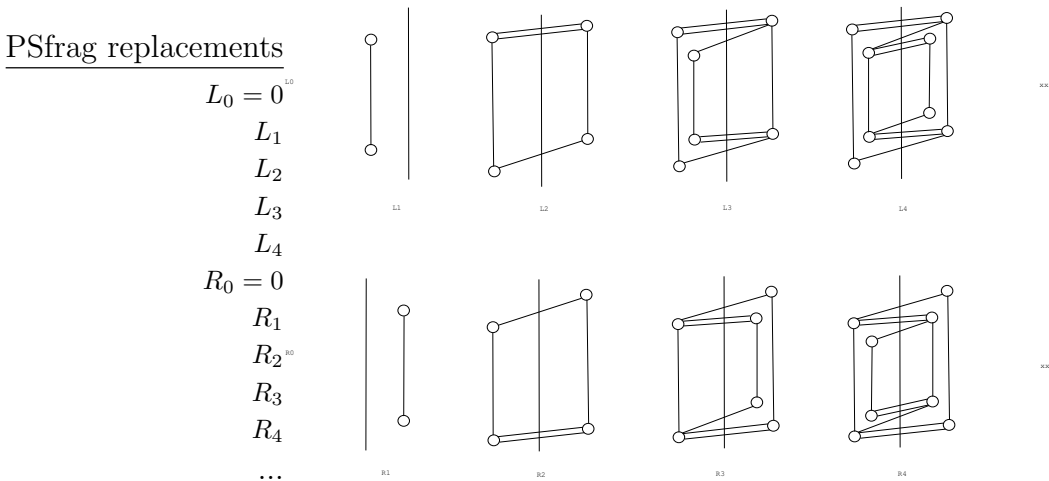

Figure 10.

**Proposition 5.9.** *Every non-zero indecomposable minimal pair of complexes belongs to one of the following classes of similar equivalence:*

$$L_k \# R_l \ (k + l > 0), \ L_k \# \begin{array}{c} \circ \\ \diagup \\ \diagdown \end{array} \# R_l \ (k + l \geq 0), \ L_k \# \begin{array}{c} | \\ \circ \end{array} \ (k \geq 0), \\ \begin{array}{c} | \\ \circ \end{array} \# R_k \ (k \geq 0), \ \begin{array}{c} \circ \\ \diagup \\ \diagdown \end{array}, \ \begin{array}{c} \circ \\ \diagup \\ \diagdown \end{array} \ . \quad \square$$

One can prove that if  $\mathcal{D}_{A,B,G}$  contains an indecomposable minimal differential  $\partial$ , then  $\mathcal{D}_{A,B,G}$  contains unique totally decomposable differential  $\delta$  such that  $H_*(\mathcal{M}_{A,\partial}) = H_*(\mathcal{M}_{A,\delta})$  and  $H(\partial) = H(\delta)$ . Since  $\mathcal{P}$  satisfies properties (1), (2) and (5) of  $M$ -model Theorem. We get the following:

????????????? UPPER

**Proposition 5.10.** *The map  $\mathcal{P}$  satisfying  $M$ -model theorem is unique.*  $\square$

It is easy to find explicitly the unique totally decomposable differential  $\delta$  mentioned above. Hence,  $\mathcal{P}$  could be defined directly, using the classification of Proposition 5.9.

Let us associate to a totally decomposable differential  $\delta$  the formal sum  $S(\delta) = \sum_{i=1}^{16} n_i \mathcal{M}_i$  where  $n_i$  is a number of direct summands in  $\mathcal{P}(\delta)$  equivalent to glyph  $\mathcal{M}_i$  (we do not take grading into account). If  $L$  is a class of similar equivalence of minimal differentials we define  $S(L) = S(\mathcal{P}(\delta))$  for a  $\delta \in L$ . Obviously,  $S(L)$  is well defined.

The following Statement describe  $S(L)$  for all classes of similar equivalence of minimal indecomposable differentials. Let  $k, l \in \mathbb{Z}_+$ .

$$\begin{aligned} \text{Statement 5.11. } & S(\begin{array}{c} \circ \\ \diagup \\ \diagdown \end{array}) = \begin{array}{c} \circ \\ \diagup \\ \diagdown \end{array}, \ S(\begin{array}{c} \circ \\ \diagup \\ \diagdown \end{array}) = \begin{array}{c} \circ \\ \diagup \\ \diagdown \end{array}, \ S(L_1) = \\ & \begin{array}{c} | \\ \circ \end{array}, \ S(L_{2+2k}) = k \begin{array}{c} \circ \\ \diagup \\ \diagdown \end{array} + \begin{array}{c} \circ \\ \diagup \\ \diagdown \end{array}, \ S(L_{3+2k}) = k \begin{array}{c} \circ \\ \diagup \\ \diagdown \end{array} + \begin{array}{c} \circ \\ \diagup \\ \diagdown \end{array}, \\ & S(L_{2k} \# R_{1+2l}) = (k+l) \begin{array}{c} \circ \\ \diagup \\ \diagdown \end{array} + \begin{array}{c} | \\ \circ \end{array}, \ S(L_{2k} \# R_{2+2l}) = (k+l) \begin{array}{c} \circ \\ \diagup \\ \diagdown \end{array} + \begin{array}{c} \circ \\ \diagup \\ \diagdown \end{array}, \\ & S(L_{1+2k} \# R_{1+2l}) = (k+l) \begin{array}{c} \circ \\ \diagup \\ \diagdown \end{array} + \begin{array}{c} \circ \\ \diagup \\ \diagdown \end{array}, \ S(L_{1+2k} \# R_{2+2l}) = (k+l) \begin{array}{c} \circ \\ \diagup \\ \diagdown \end{array} + \\ & \begin{array}{c} \circ \\ \diagup \\ \diagdown \end{array}, \ S(L_{2k} \# \begin{array}{c} \circ \\ \diagup \\ \diagdown \end{array}) = k \begin{array}{c} \circ \\ \diagup \\ \diagdown \end{array} + \begin{array}{c} \circ \\ \diagup \\ \diagdown \end{array}, \ S(L_{1+2k} \# \begin{array}{c} \circ \\ \diagup \\ \diagdown \end{array}) = k \begin{array}{c} \circ \\ \diagup \\ \diagdown \end{array} + \begin{array}{c} \circ \\ \diagup \\ \diagdown \end{array}, \\ & S(L_{2k} \# \begin{array}{c} \circ \\ \diagup \\ \diagdown \end{array} \# R_{1+2l}) = (k+l) \begin{array}{c} \circ \\ \diagup \\ \diagdown \end{array} + \begin{array}{c} \circ \\ \diagup \\ \diagdown \end{array} + \begin{array}{c} | \\ \circ \end{array}, \ S(L_{2k} \# \begin{array}{c} \circ \\ \diagup \\ \diagdown \end{array} \# R_{2+2l}) = \\ & (k+l) \begin{array}{c} \circ \\ \diagup \\ \diagdown \end{array} + \begin{array}{c} \circ \\ \diagup \\ \diagdown \end{array} + \begin{array}{c} \circ \\ \diagup \\ \diagdown \end{array}, \ S(L_{1+2k} \# \begin{array}{c} \circ \\ \diagup \\ \diagdown \end{array} \# R_{1+2l}) = (k+l) \begin{array}{c} \circ \\ \diagup \\ \diagdown \end{array} + \\ & \begin{array}{c} \circ \\ \diagup \\ \diagdown \end{array} + \begin{array}{c} \circ \\ \diagup \\ \diagdown \end{array}, \ S(L_{1+2k} \# \begin{array}{c} \circ \\ \diagup \\ \diagdown \end{array} \# R_{2+2l}) = (k+l) \begin{array}{c} \circ \\ \diagup \\ \diagdown \end{array} + \begin{array}{c} \circ \\ \diagup \\ \diagdown \end{array} + \begin{array}{c} \circ \\ \diagup \\ \diagdown \end{array}, \\ & S(L_{2k} \# \begin{array}{c} | \\ \circ \end{array}) = k \begin{array}{c} \circ \\ \diagup \\ \diagdown \end{array} + \begin{array}{c} | \\ \circ \end{array}, \ S(L_{1+2k} \# \begin{array}{c} | \\ \circ \end{array}) = k \begin{array}{c} \circ \\ \diagup \\ \diagdown \end{array} + \begin{array}{c} \circ \\ \diagup \\ \diagdown \end{array}, \ S(\begin{array}{c} | \\ \circ \end{array}) = \begin{array}{c} | \\ \circ \end{array}, \\ & S(\begin{array}{c} | \\ \circ \end{array} \# R_{1+2k}) = k \begin{array}{c} \circ \\ \diagup \\ \diagdown \end{array} + \begin{array}{c} \circ \\ \diagup \\ \diagdown \end{array}, \ S(\begin{array}{c} | \\ \circ \end{array} \# R_{2+2k}) = k \begin{array}{c} \circ \\ \diagup \\ \diagdown \end{array} + \begin{array}{c} \circ \\ \diagup \\ \diagdown \end{array}. \quad \square \end{aligned}$$

One can easily show (using Proposition 5.9) that any two similar minimal differentials are equivalent. We say that a minimal differential  $\delta$  is *distinguished* if for any  $e \in E$ ,  $f \in F$ ,  $d \in D$ ,  $b \in B$  we have  $\langle \delta(e), b \rangle, \langle \delta(d), b \rangle \in \{0, 1\}$  and  $\langle \delta(f), b \rangle \in \{0, -1\}$ . One can show that for every  $\partial \in \mathcal{D}_{A,B,G}$  there exists a unique distinguished minimal differential in  $\mathcal{D}_{A,B,G}$  weakly equivalent to  $\partial$ . Denote this distinguished differential  $\mathcal{P}_{\min}(\partial)$ . Thus, by construction, the map  $\mathcal{P}$  from  $M$ -model theorem is a composition of  $\mathcal{P}_{\min}$  with a uniquely defined map from distinguished differentials to totally decomposable differentials.

*5.6. On different equivalency relations.* It is easy to show that  $\mathcal{D}_{A,B,G}$  contains a finite number of totally decomposable differentials. Hence, by Theorem 3.3,  $\mathcal{D}_{A,B,G}$  is a disjoint union of finite number of  $G$ -equivalency classes.

One can show using results of Sec. 5.5 that each  $G$ -equivalency class is a disjoint union of a finite numbers of weak equivalency classes. The map  $\mathcal{P}$  itself generates an equivalence relation on  $\mathcal{D}_{A,B,G}$ :  $\partial \sim_{\mathcal{P}} \partial_1$  if  $\mathcal{P}(\partial) = \mathcal{P}(\partial_1)$ . This equivalence relation subdivides  $G$ -equivalence.

*5.7. Proof of Lemma 5.7.* The following Lemmas help to detect direct summands of minimal differentials.

**Lemma 5.12.** *Consider an  $M$ -pair  $\mathcal{M}_{A,B,G,\delta}$ ,  $A = \{a_1, \dots, a_n\}$ . Let  $\delta$  be a minimal differential.*

- (1) *An element  $p \in P$  appears in at most two vectors  $\delta(a_i)$ ,  $a_i \in A \setminus B$ . It appears in two such vectors if and only if  $p \in G$ ,  $p \in H(\delta)$  and  $p_+ \neq h_+(p)$ . The element  $p$  does not appear in all  $\delta(a_i)$  if and only if  $p \notin G$  and  $p \notin H(\delta)$ . In all other cases  $p$  appears in one vector  $\delta(a_i)$ .*
- (2) *For  $d \in D$  the vector  $\delta(d)$  contains at most two elements. It contains two elements if and only if  $d = h_+(p)$  and  $d = x_+$  for some elements  $p \in H(\delta)$ ,  $x$  in  $B$  such that  $p \neq x$ .*
- (3) *For  $e \in E$  the vector  $\delta(e)$  contains at most two elements from the set  $B$ . The vector  $\delta(e)$  contains two elements from  $B$  only if  $e \in G_+$ .*
- (4) *For  $f \in F$  the vector  $\delta(f)$  contains at most two elements from the set  $B$ . Let  $e \in E$  satisfies  $\delta_{A \setminus B}(e) = f$ . The vector  $\delta(f)$  contains two elements from the set  $B$  if and only if  $f \in G_+$ ,  $e \in G_+$ , such that  $e = q_+$  for  $q \in Q$  and  $(\delta(q), f)$  is not a  $G$ -pair. If  $f \notin G_+$  then  $\delta(f) \neq 0$  only if  $e = q_+$  for some element  $q \in Q$ .*
- (5) *An element  $r \in R$  appears in at most two vectors  $\delta(a)$ ,  $a \in A \setminus B$ .*

*Proof.* ????? left to reader □

Let  $\delta$  be a first case minimal differential.

**Lemma 5.13.** (1) *An element  $r \in R$  appears in at most one vector  $\delta(a)$ ,  $a \in A \setminus B$ .*



- (2) An element  $q \in Q$  appears in at most one vector  $\delta(a)$ ,  $a \in A \setminus B$ .  
 If  $q \notin G$  then it appears in one such a vector if and only if  
 $r = \delta(q) \in G$  and  $r_+ \in F$ .

*Proof.* Consider an element  $r \in R$ . If  $\langle \delta(a), r \rangle \neq 0$ , for  $a \in A \setminus B$  then  $(r, a)$  satisfy to at least one of conditions of Lemma 5.2. Note that there is at most one pair  $(r, a)$  which is not a  $G$ -pair and satisfying the condition (4). Hence, if  $r \notin G$  then  $r$  appears in at most one vector  $\delta(a)$  for  $a \in A \setminus B$ . If  $r \in G$  then suppose that there are two elements  $a_1, a_2 \in A \setminus B$  such that  $\langle \delta(a_i), r \rangle \neq 0$ . One of pairs  $(r, a_1)$   $(r, a_2)$  satisfy to the condition (1) of Lemma 5.2 and another satisfy to the condition (1). Without loss of generality we can assume that  $a_1 = r_+$ . Consider element  $q \in Q$  such that  $\delta(q) = r$ . Then  $(r, a_2)$  satisfy the condition (4) of Lemma 5.2. Since  $(r, a_2)$  is not a  $G$ -pair we get that  $q \in G$  and  $\delta$  is not a first case differential. This contradiction finishes the proof of the first claim of Lemma.

Let  $q \in Q$  appears in two vectors  $\delta(a)$  for  $a \in A \setminus B$ . Then  $q \in G$  and one of such elements  $a$  must be equal to  $q_+$ . For the second element  $a$  we have  $a \in E$  and  $(\delta(q), \delta_{A \setminus B})$  is a  $G$ -pair. Hence we  $\delta$  is not a first case differential.  $\square$

We study all the various possibilities. Let  $A = \{a_1, \dots, a_n\}$ . Consider the sets  $P, Q, R, E, F, D$  and the map  $h_+$  generated by  $\delta$ . In what follows we consider a full tree of possibilities and study all its vertexes. Instead of notations  $\mathcal{M}_i$  we will use corresponding pictures.

Firstly we split the further consideration into the following two possibilities: (1)  $B \neq \emptyset$  and (2)  $B = \emptyset$ .

Consider the case (1) firstly. We split the case (1) into (1.1)  $P \neq \emptyset$  and (1.2)  $P = \emptyset$ . Consider (1.1). Let us fix  $p \in P$ . We divide (1.1) into two subcases (1.1.1)  $p \in G$  and (1.1.2)  $p \notin G$ .

Consider the case (1.1.1). We divide it in (1.1.1.1)  $p \in H(\delta)$  and (1.1.1.2)  $p \notin H(\delta)$ .

In the case (1.1.1.1) there are two possibilities  $p_+ = h_+(p)$  and  $p_+ \neq h_+(p)$ .

For the first possibility we have that the space spanned on  $p, h_+(p)$  is a direct summand. Indeed,  $\delta(p_+)$  contains the element  $p$  only by Lemma 5.12(2). Hence  $\mathbb{E} \otimes \{p, h_+(p)\}$  is  $\delta$ -invariant. The element  $p$  appears in  $\delta(a_i), a_i \in A \setminus B$  only if  $a_i = p_+$  by Lemma 5.12(1). Since  $\delta$  is indecomposable we get:  $A = \{p, p_+\}$  and  $\mathcal{M}_\delta$  is similar to .

For the second possibility we consider the element  $p_+$  and  $h_+(p)$  (see notations on Fig??). These elements satisfy inequalities  $p \prec p_+ \prec h_+(p)$  and  $p_+ \in E$  because the possibility  $p_+ \in D$  is impossible since  $\delta$  is quasi-elementary and  $p_+ \in F$  is impossible since  $\delta^2 = 0$ . Hence the set  $A$  contains at least four elements  $p, h_+(p), p_+, \delta_{A \setminus B}(p_+)$ . There are four new cases  $(\delta_{A \setminus B}(p_+) \in G_+, h_+(p) \in G_+)$ ,  $(\delta_{A \setminus B}(p_+) \in G_+, h_+(p) \notin G_+)$ ,  $(\delta_{A \setminus B}(p_+) \in G_+, h_+(p) \notin G_+)$  and  $(\delta_{A \setminus B}(p_+) \notin G_+, h_+(p) \notin G_+)$ .



We claim that in those cases  $\delta$  is similar to  $\mathcal{A}_i$ ,  $i \in \{1, \dots, 4\}$  respectively. Let us prove the first claim, namely  $(\delta_{A \setminus B}(p_+) \in G_+, h_+(p) \in G_+)$  implies  $\mathcal{M}_\delta$  is similar to  $\mathcal{A}_1$ .

Since  $h_+(p) \in G_+$   $h_+(p) = r_+$  for some element  $r$ . It follows from the minimality of  $\delta$  that  $r \in R$  and hence there exists  $q \in Q$  such that  $\delta(q) = r$ . Analogously there exist elements  $\tilde{q} \in Q, \tilde{r} \in R$  such that  $\delta(\tilde{q}) = \tilde{r}$  and  $\tilde{r}_+ = \delta_{A \setminus B}(p_+)$ . By the assumption of Lemma neither  $q$  nor  $\tilde{q}$  contains in  $G$ . The vector space spanned on  $C = \{p, p_+, h_+(p), \delta_{A \setminus B}(p_+), q, r, \tilde{q}, \tilde{r}\}$  is a direct summand of  $\delta$ . Indeed, applying Lemma 5.12(3), 5.12(1) and 5.12(4) correspondingly to elements  $p_+, h_+(p), \delta_{A \setminus B}(p_+)$  we get  $\delta(p_+), \delta(h_+(p)), \delta(\delta_{A \setminus B}(p_+)) \in E \otimes C$ . The value of  $\delta$  on all other elements of  $C$  belongs to  $E \otimes C$  since  $\delta$  is quasi-elementary. Hence  $E \otimes C$  is  $\delta$ -invariant. Applying Lemma 5.12(1) to the element  $p$  we see that  $p$  contains in  $\delta(a_i), a_i \in A \setminus B$  only if  $a_i \in C$ . By Lemma 5.13 elements  $q, r, \tilde{q}, \tilde{r}$  contains in  $\delta(a_i), a_i \in A \setminus B$  only if  $a_i \in C$ . Hence  $E \otimes C$  is a direct summand of  $M_\delta$ . Since  $\delta$  is indecomposable it follows that  $\mathcal{M}_\delta$  is similar to  $\mathcal{A}_1$ . Consideration of the remaining three cases is completely analogous to the case considered. We are finished with (1.1.1.1).

Further considerations are similar to previous one. In each case we construct a corresponding set  $C$  and prove (using Lemma 5.12 and Lemma 5.13) that  $E \otimes C$  is a direct summand of  $M_\delta$ . We leave the proof of last statement to the reader and only describe  $C$  and answer.

Now we consider the case (1.1.1.2). For that case  $p_+ \in E$  and there are two possibilities  $\delta_{A \setminus B}(p_+) \notin G_+$  and  $\delta_{A \setminus B}(p_+) \in G_+$ . For the first possibility we get  $C = \{p, p_+, \delta_{A \setminus B}(p_+)\}$  and  $\mathcal{M}_\delta$  is similar to . For the second possibility we consider  $r$  such that  $r_+ = \delta_{A \setminus B}(p_+)$ . The element  $r$  belongs to  $R$  since  $\delta^2(p_+) = 0$ , hence there exists  $q \in Q$  such that  $\delta(q) = r$ . The following inequalities holds  $r \prec \delta_{A \setminus B}(p_+) \prec q \prec p \prec p_+$  and  $C = \{p, p_+, \delta_{A \setminus B}(p_+), q, r\}$ . In this case  $\mathcal{M}_\delta$  is similar to



Consider the case (1.1.2)( $p \notin G$ ). If  $p \in H(\delta)$  we consider element  $h_+(p)$ . If  $h_+(p) \notin G_+$  then  $C = \{p, h_+(p)\}$  and  $\mathcal{M}_\delta$  is similar to . If  $h_+(p) \in G_+$  then  $h_+(p) = r_+$  for some element  $r \in R$ . Hence there exists  $q \in Q$  such that  $\delta(q) = r$ . In that case  $C = \{p, h_+(p), q, r\}$  and  $\mathcal{M}_\delta$  is similar to . If  $p \notin H(\delta)$  then  $C = \{p\}$  and  $\mathcal{M}_\delta$  is similar to .



Now we consider (1.2) ( $P = \emptyset$ ). In that case  $B$  contains at least two elements  $q, r$  such that  $\delta(q) = r$ . We fix such a pair of elements and split (1.2) into four cases: (1.2.1) ( $q \in G, r \in G$ ), (1.2.2) ( $q \in G, r \notin G$ ), (1.2.3) ( $q \notin G, r \in G$ ) and (1.2.4) ( $q \notin G, r \notin G$ ).

In the case (1.2.1) we have  $\delta_{A \setminus B}(q_+) = r_+$  since  $\delta$  is a first case minimal differential,  $C = \{q, r, q_+, r_+\}$  and  $\mathcal{M}_\delta$  is similar to .



In the case (1.2.2) we consider element  $\delta_{A \setminus B}(q_+)$ . If  $\delta_{A \setminus B}(q_+) \notin G_+$  then  $C = \{q, r, q_+, \delta_{A \setminus B}(q_+)\}$  and  $\mathcal{M}_\delta$  is similar to . If  $\delta_{A \setminus B}(q_+) \in G_+$  then  $\delta_{A \setminus B}(q_+) = \tilde{r}$  for some  $\tilde{r} \in R$ , there exists  $\tilde{q} \in Q$  such that  $\delta(\tilde{q}) = \tilde{r}$ , elements of the set  $C = \{q, r, q_+, \delta_{A \setminus B}(q_+), \tilde{q}, \tilde{q}\}$  satisfy inequalities



$$r \prec \tilde{r} \prec \delta_{A \setminus B}(q_+) \prec \tilde{q} \prec q \prec q_+$$

and  $M_\delta$  is similar to .

In the case (1.2.3) consider element  $r_+$ . There are three possibilities:  $r_+ \in D$ ,  $r_+ \in E$  and  $r_+ \in F$ . For the first one we get  $C = \{q, r, r_+\}$  and  $\mathcal{M}_\delta$  is similar to . In the second case consider element  $\delta_{A \setminus B}(r_+)$ . If  $\delta_{A \setminus B}(r_+) \notin G_+$  then  $C = \{q, r, r_+, \delta_{A \setminus B}(r_+)\}$  and  $M_\delta$  is similar to . If  $\delta_{A \setminus B}(r_+) \in G_+$  consider  $\tilde{r}$ , such that  $\tilde{r}_+ = \delta_{A \setminus B}(r_+)$ . Since  $\delta^2(r_+) = 0$  we have  $\tilde{r} \in R$  and there exists  $\tilde{q} \in Q$  such that  $\delta(\tilde{q}) = \tilde{r}$ .

In that case  $C = \{q, r, r_+, \delta_{A \setminus B}(r_+), \tilde{r}, \tilde{q}\}$  and  $M_\delta$  is similar to . In the last subcase of (1.2.3)  $r_+ \in F$  consider  $e \in E$  such that  $\delta_{A \setminus B}(e) = f$ .

If  $e \notin G_+$   $C = \{q, r, r_+, e\}$  and  $M_\delta$  is similar to . The possibility  $e \in G_+$  leads to either to already considered case of  $M$ -pair similar to  or to  $M$ -pair from (1.2.2) or to  $P \neq \emptyset$ .

In the case (1.2.4)  $C = \{q, r\}$  and  $M_\delta$  is similar to . It finishes the consideration of (1). The case (2) is very short: either  $A$  is one element set and  $M_\delta$  is similar to  or  $A$  is a set of two elements and  $M_\delta$  is similar to .

The proof of Lemma 5.7 is finished.

**5.8. Proof of Lemma 5.8.** We are proving Lemma 5.8 for the case  $n \in G_+$ . By  $P, Q, R, E, F, D$  and  $h_+$  we denote sets and the map generated by  $\delta$ .

First of all we prove that  $\delta' = \delta'(\delta)$  is  $M$ -differential. In order to prove that  $\delta'$  is  $M$ -differential we must show that  $\delta'$  satisfies the “decreasing order” (see sec. 2.7) on such elements  $a \in A$  that  $\delta'(a) \neq \delta(a)$ . Since  $\delta$  is quasi-elementary  $\delta'(a_i) \neq \delta(a_i)$  for an element  $a_i \in A$  only if  $a_i \in \{r_+, n\}$  or  $\delta(a_i)$  contains either  $r_+$  or  $n$ .

Let us show that  $\delta'$  satisfies the “decreasing order” on  $r_+$ . Indeed,  $\delta'(r_+) = \delta(n - \gamma\tilde{q}) = \delta(n) - \gamma\tilde{r}$ . By Lemma 5.12(4)  $\delta(n) = \gamma\tilde{r} + \beta r$ .

Hence  $\delta'(r_+) = \beta r$  and  $\delta'$  satisfies the “decreasing order” condition on  $r_+$ .

Let us show that  $\delta'$  satisfies the “decreasing order” on  $n$ . Indeed,  $\delta'(n) = \delta(r_+ - \alpha q + \gamma \tilde{q}) = \delta(r_+) - \alpha r + \gamma \tilde{r}$ . Since  $r_+ \prec n$  and  $\delta$  satisfies the “decreasing order” condition on  $r_+$ ,  $\delta'(n)$  contains only elements less than  $n$ .

Since  $\delta$  is quasi-elementary the element  $n$  appears in a vector  $\delta(a)$ ,  $a \in A$  if and only if  $a = q_+$ . Let us show that  $\delta'$  decrease order on  $q_+$ . Indeed, by Lemma 5.12(3) and Lemma 5.1  $\delta(q_+) = n - \gamma \tilde{q} - \beta q$ . Hence  $\delta'(q_+) = S(n - \gamma \tilde{q} - \beta q) = r_+ - \beta q$ , since  $S(r_+) = n + \gamma \tilde{q}$ .

Element  $r_+$  appears in a vector  $\delta(a)$ ,  $a \in A$  only if  $r_+ \in F$ . In that case there exists a unique element  $e \in E$  such that  $\delta_{A \setminus B} = r_+$ . Element  $e$  bigger than  $q_+$ . Indeed, by Lemma 5.1  $q \prec e$  and  $e \neq q_+$  since  $\delta_{A \setminus B}$  is elementary. Hence,  $\delta'(e) = \delta(e) - r_+ + S(r_+) = \delta(e) - r_+ + n + \alpha q - \gamma \tilde{q}$ . The latter implies that  $\delta'$  satisfies the “decreasing order” condition on  $e$ . Hence  $\delta'$  is an  $M$ -differential.

Let us show that  $\delta' \in \mathcal{D}_{A,B,G}$ . Let  $r_+ \in F$ . Consider a  $G$ -pair  $(x, x_+)$ . If  $x_+ \notin \{r_+, n, q_+, e\}$  then  $\delta'(x_+) = \delta(x_+)$  and  $x$  is  $\delta'$ -trivial element. If  $x_+ \in \{r_+, n, q_+\}$  then  $x$  is a  $\delta'$ -trivial element by computations of  $\delta'(x_+)$  above. If  $e = x_+$  for  $x \in G$  then  $q_+ \prec x$  and by Lemma 5.12(3) and Lemma 5.1  $\delta(e) = \tau x - \alpha q + r_+$  for  $\tau \neq 0$ . Hence,  $\delta'(e) = \tau x - \gamma \tilde{q} + n$  and  $(x, e)$  is  $\delta'$ -pair. Thus  $\delta' \in \mathcal{D}_{A,B,G}$ .

$M$ -differential  $\delta'$  is quasi-elementary. Indeed,  $\delta'_B = \delta_B$ ,  $\delta'_i \circ A \setminus B = T\delta_i \circ A \setminus B$  where  $T$  is a transposition sending  $n$  to  $r_+$ . Hence  $\delta'_B, \delta'_{A \setminus B} = T\delta_{A \setminus B}$  are elementary differentials. For elements  $p \in P$ ,  $d \in D \setminus \{r_+\}$   $\langle \delta'(d), p \rangle = \langle \delta(d), p \rangle$ . It proves that that  $\delta'$  is quasi-elementary and  $h_+(\delta') = h_+(\delta)$  in the case  $r_+ \notin D$ . If  $r_+ \in D$  then  $h_+(\delta') = Th_+(\delta)$ .

Differential  $\delta'$  is decomposable. Let us show that  $\mathbb{E} \otimes \{q, r, r_+, q_+\}$

is a direct summand. (This summand, in fact, is similar to . It is the place in the proof where we use minimality of  $\delta$ .) The subspace  $\mathbb{E} \otimes \{q, r, r_+, q_+\}$  is  $\delta'$ -invariant by computations above. The element  $q$  appears in  $\delta(a)$  for  $a \in A$  only if  $a = q_+$  by Lemma 5.13(2). Hence  $q$  appears in  $\delta'(a)$  for  $a \in A$  only if  $a = q_+$ . The element  $r$  appears in  $\delta(a)$  for  $a \in A \setminus B$  only if  $a \in \{r_+, n\}$  by Lemma 5.12(5). Hence, using the above computations we get that  $r$  appears in  $\delta'(a)$ ,  $a \in A \setminus B$  only if  $a = r_+$ . The set  $A \setminus \{q, r, r_+, q_+\}$  contains the element  $n$  and therefore non-empty. It proves that  $\delta'$  is decomposable.

Differentials  $\delta'_1 = \delta'(\delta_1)$  and  $\delta'_2 = \delta'(\delta_2)$  are similar if  $\delta_1, \delta_2$  are similar. Indeed, if  $\delta'_1(x)$  contains  $v$  for  $x \in A \setminus B, v \in B$  then  $\delta'_2(x)$  is also containing  $v$ . For  $x \notin \{q_+, r_+, n, e\}$  it is true since  $\delta'_i(x) = \delta_i(x)$ ,  $i \in \{1, 2\}$ , for  $x \in \{q_+, r_+, n, e\}$  it follows from the above computations.

To prove Lemma for  $n \notin G$  it is sufficiently to substitute  $\gamma = 0$  into the proof for the case  $n \in G$  above. The proof of Lemma 5.8 is finished.

## 6. GRAPH AND COLORINGS

Consider the finite graded linearly ordered set  $B$  (grading is a function  $\text{deg}: B \rightarrow \mathbb{Z}$ ). We suppose that  $B$  is equipped with a decomposition into disjoint union of pairs of elements and single elements. Let  $G$  be a subset of  $B$ ,  $H$  be a subset of the set of all single elements in  $B$ . Any  $M$ -differential  $\partial \in \mathcal{D}_{A,B,G}$  generates such a combinatorial structure, where decomposition of  $B$  is the decomposition in  $\partial_B$ -pairs and  $\partial_B$ -homologically essential elements and  $H = H(\partial)$  is a set of all boundary essential elements (see ???). Motivated by this example we call pairs from the decomposition of  $B$  into disjoint union of pairs and single elements by  $\partial_B$ -pairs and we call single elements  $\partial_B$ -homologically essential elements.

Let  $(d_k)_{k \in \mathbb{Z}}$  be an auxiliary data — collection of nonnegative integers such that all of them but finite number are zero. In such a situation we define the graph  $\Gamma = \Gamma(B, G, H, (d_k)_{k \in \mathbb{Z}})$  as follows.

*6.1. Definition of vertices.* The graph  $\Gamma = \Gamma(\partial, G)$  has vertices of five different graded types  $A_k, B_k, C_k, D_k$  and  $E_k, k \in \mathbb{Z}$ .

(1) Let  $(b_i, b_j), i > j$  be a  $\partial_B$ -pair, such that  $b_j \in G, b_i \notin G$ . To each such a pair we correspond a vertex in the graph  $\Gamma$ . We say that this vertex is the vertex of type  $A_k$  (or  $\Downarrow_k$ ), where  $k = \text{deg}(b_j)$ .

(2) Let  $(b_i, b_j), i > j$  be a  $\partial_B$ -pair, such that  $b_j \notin G, b_i \in G$ . To each such a pair we correspond a vertex in the graph  $\Gamma$ . We say that this vertex is the vertex of type  $B_k$  (or  $\Uparrow_k$ ), where  $k = \text{deg}(b_j) + 1$ .

(3) Let  $b_i \in G$  be  $\partial_B$ -homologically essential element, such that  $b_i \notin H$ . To each such an element we correspond a vertex in the graph  $\Gamma$ . We say that this vertex is the vertex of type  $C_k$  (or  $\dashv_k$ ), where  $k = \text{deg}(b_i)$ .

(4) Let  $b_i \in H(\partial)$  satisfy  $b_i \notin G$ . To each such an element we correspond a vertex in the graph  $\Gamma$ . We say that this vertex is the vertex of type  $D_k$  (or  $\Uparrow_k$ ), where  $k = \text{deg}(b_i) + 1$ .

(5) For each  $k$  the graph  $\Gamma$  contains  $d_k$  vertexes of type  $E_k$ .

We say that the number  $k$  above is a *degree* of a vertex. The degree  $k$  of a vertex  $v$  we denote by  $k(v)$ .

*6.2. Definition of edges.* Two vertexes of  $\Gamma$  are connected by at most one edge. All edges of the graph  $\Gamma$  are oriented. Each edge starts at a vertex of the type  $A_k$  for some  $k$  and finishes at a vertex of degree  $k + 1$ . Consider a vertex  $(b_i, b_j)$  of the type  $A_k$ . There are following possibilities only:

(1) The vertex  $(b_i, b_j)$  is connected with a vertex  $(b_l, b_m)$  of the type  $A_{k+1}$  if and only if  $i < m$ .

(2) The vertex  $(b_i, b_j)$  is connected with a vertex  $(b_l, b_m)$  of the type  $B_{k+1}$  if and only if  $i < l, m < j$ .

(3) The vertex  $(b_i, b_j)$  is connected with a vertex  $b_l$  of the type  $C_{k+1}$  if and only if  $i < l$ .

(4) The vertex  $(b_i, b_j)$  is connected with a vertex  $b_l$  of the type  $D_{k+1}$  if and only if  $l < j$ .

(5) The vertex  $(b_i, b_j)$  is connected with each vertex of the type  $E_{k+1}$ .

The construction of the graph  $\Gamma$  is finished.

For  $\partial \in \mathcal{D}_{A,B,G}$  we define the graph  $\Gamma(\partial, G)$  to be  $\Gamma = \Gamma(B, G, H, (d_k)_{k \in \mathbb{Z}})$ , where  $d_k$  is the dimension of the kernel of the connecting homomorphism  $H_k(\mathcal{M}_{A,\partial}, \mathcal{M}_{B,\partial_B}) \rightarrow H_{k-1}(\mathcal{M}_{B,\partial_B})$  from the long exact sequence of the pair  $(\mathcal{M}_{A,\partial}, \mathcal{M}_{B,\partial_B})$ .

*6.3. Remark.* Inequalities from the definition of edges (1)–(4) mean that the considered in the definition vertex of the type  $A_k$  and the vertex of the type  $A_{k+1}$  ( $B_{k+1}$ ,  $C_{k+1}$ ,  $D_{k+1}$  respectively) could be left

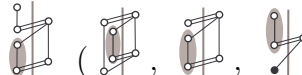
part of a corresponding glyph:  ( , , , respectively). The vertex  $(b_i, b_j)$  is marked on these pictures.

*6.4. Colorings of the graph  $\Gamma$ . Admissible polynomials.* Consider the graph  $\Gamma = \Gamma(B, G, H, (d_k)_{k \in \mathbb{Z}})$ . A *matching* of a graph is a collection of edges without common vertexes. Consider a matching  $\Sigma$ , denote by  $V_\Sigma$  the set of all vertexes of  $\Gamma$  which are not ends of edges from  $\Sigma$ . We say that  $s: V_\Sigma \rightarrow \{0, 2\}$  is an *admissible* map, if for any  $k$  and any vertex  $v$  of type  $B_k$ ,  $C_k$ ,  $D_k$  or  $E_k$  holds  $s(v) = 0$ . A *coloring* of the graph  $\Gamma$  is a pair  $(\Sigma, s)$  of a matching and an admissible map.

We correspond to a coloring  $(\Sigma, s)$  of  $\Gamma$  a polynomial  $P_{\Sigma,s}$  by the following rule. To a vertex  $v \in V_\Sigma$  we assign the monomial  $t^{k(v)+s(v)}$ . We define the polynomial  $P_{\Sigma,s}$  to be a sum of all the monomials over  $V_\Sigma$  if  $V_\Sigma \neq \emptyset$ , if  $V_\Sigma = \emptyset$  we define  $P_{\Sigma,s}$  to be zero polynomial. We call such a polynomials as admissible polynomials. The set of all admissible polynomials we denote by  $\mathcal{P}_{\text{Adm}}(B, G, H, (d_k)_{k \in \mathbb{Z}})$ . If  $\Gamma = \Gamma(\partial, G)$  we will also denote the set of admissible polynomials by  $\mathcal{P}_{\text{Adm}}(\partial, G)$ . Obviously, the set of all colorings of  $\Gamma$  and, hence, the set of all admissible polynomials is finite.

*6.5. Isomorphism between graphes.* Consider two triples of  $(A \supset B \supset G)$  and  $(A' \supset B \supset G)$  of finite linearly ordered graded sets. We assume that the grading and order on  $B$  induced from  $A$  and from  $A'$  coincide. Let  $\partial \in \mathcal{D}_{A,B,G}$ ,  $\partial' \in \mathcal{D}_{A',B,G}$ .

**Lemma 6.1.** *Suppose that  $\partial_B$  is equivalent to  $\partial'_B$ ,  $H(\partial) = H(\partial')$  and  $H_*(\mathcal{M}_{A,\partial}, \mathcal{M}_{B,\partial_B}) \approx H_*(\mathcal{M}_{A',\partial'}, \mathcal{M}_{B,\partial'_B})$ ,  $H_*(\mathcal{M}_{A,\partial}) \approx H_*(\mathcal{M}_{A',\partial'})$ . Then there exists an isomorphism  $\Gamma(\partial, G) \rightarrow \Gamma(\partial', G)$  which preserves the type of vertexes.*

*Proof.* Indeed, the graph  $\Gamma(\partial, G)$  was constructed by  $\partial_B$ -pairs, the set  $H(\partial)$  and the numbers  $d_k$ . Since  $\partial_B \sim \partial'_B$  we have  $H_*(\mathcal{M}_{B,\partial}) \approx H_*(\mathcal{M}_{B,\partial'_B})$ . Therefore, it is sufficient to show that the numbers  $d_k$  depends on  $H_*(\mathcal{M}_{A,\partial}, \mathcal{M}_{B,\partial_B})$ ,  $H_*(\mathcal{M}_{A,\partial})$ ,  $H_*(\mathcal{M}_{B,\partial})$  only.

Consider Poincaré-Laurent polynomials  $P(\mathcal{M}_{A,\partial}, \mathcal{M}_{B,\partial_B})$ ,  $P(\mathcal{M}_{A,\partial})$  and  $P(\mathcal{M}_{B,\partial_B})$  which are equal  $\sum \dim H_k(\mathcal{M}_{A,\partial}, \mathcal{M}_{B,\partial_B})t^k$ ,  $\sum \dim H_k(\mathcal{M}_{A,\partial})t^k$  and  $\sum \dim H_k(\mathcal{M}_{B,\partial_B})t^k$  correspondingly.

Denote by  $i_{k-1}$  the dimension of the image of the map  $H_k(\mathcal{M}_{A,\partial}, \mathcal{M}_{B,\partial_B}) \rightarrow H_{k-1}(\mathcal{M}_{B,\partial_B})$  from the long exact sequence of the pair  $(\mathcal{M}_{A,\partial}, \mathcal{M}_{B,\partial_B})$ . Consider Laurent polynomials  $D, I$  defined by  $D(t) = \sum d_k t^k$ ,  $I(t) = \sum i_k t^k$ . Lemma 6.1 follows from next Lemma.

**Lemma 6.2.** *The polynomials  $I$  and  $D$  satisfy the equalities:*

$$P(\mathcal{M}_{A,\partial}, \mathcal{M}_{B,\partial_B})(t) = D(t) + \frac{1}{t}I(t),$$

$$P(\mathcal{M}_{B,\partial})(t) + P(\mathcal{M}_{A,\partial}, \mathcal{M}_{B,\partial_B})(t) = P(\mathcal{M}_{A,\partial})(t) + I(t)(1+t).$$

*Proof.* Indeed,  $\dim H_k(\mathcal{M}_{A,\partial}, \mathcal{M}_{B,\partial_B}) = d_k + i_{k-1}$ . It is equivalent to the first equality. Let  $l_k$  be the dimension of the image the map  $H_k(\mathcal{M}_{B,\partial_B}) \rightarrow H_k(\mathcal{M}_{A,\partial})$  from the long exact sequence of the pair  $(\mathcal{M}_{A,\partial}, \mathcal{M}_{B,\partial_B})$ . Exactness of the long exact sequence implies  $\dim H_k(\mathcal{M}_{B,\partial_B}) = i_k + l_k$ ,  $\dim H_k(\mathcal{M}_{A,\partial}) = l_k + d_k$ . Hence,

$$\dim H_k(\mathcal{M}_{B,\partial_B}) + \dim H_k(\mathcal{M}_{A,\partial}, \mathcal{M}_{B,\partial_B}) = \dim H_k(\mathcal{M}_{A,\partial}) + i_k + i_{k-1},$$

which is equivalent to the second equality.  $\square$

The following lemma is an obvious corollary of Lemma 6.1.



**Lemma 6.3.** *If differentials  $\partial, \partial'$  satisfy the assumptions of Proposition 6.1, then  $\mathcal{P}_{\text{Adm}}(\partial, G) = \mathcal{P}_{\text{Adm}}(\partial', G)$ .*  $\square$

**6.6. The construction of colorings from  $M$ -differentials.** We are going to construct a distinguished coloring of the graph  $\Gamma(\partial, G)$ .

Consider the  $M$ -model  $\mathcal{P}(\partial)$  of a  $M$ -differential  $\partial$  given by Theorem 3.3. We label each glyph by the smallest degree of its basis elements. We define a map  $\Psi$  from the set of vertexes of  $\Gamma(\partial, G)$  to the set of glyphs from  $\mathcal{P}(\partial)$  as follows:

Each vertex of the type  $\Downarrow_k, \Uparrow_k, \dagger_k$  or  $\downarrow_k$  naturally corresponds either to a single element or a pair of elements of the set  $B$ . This element or a pair of elements is a part of a basis of a single glyph from  $\mathcal{P}(\partial)$ . Let  $\Psi$  maps each vertex of the type  $\Downarrow_k, \Uparrow_k, \dagger_k$  or  $\downarrow_k$  to a glyph from  $\mathcal{P}(\partial)$ , such that its basis contains the elements generating the vertex. Thus,  $\Psi$  is defined on all vertexes of types  $A_k, B_k, C_k$  and  $D_k$ . Now we define  $\Psi$  on vertexes of the type  $E_k$ .

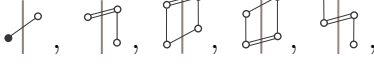
The number  $d_k$  from the definition of the graph  $\Gamma(\partial, G)$  is equal to the number of all glyphs of types  $\Downarrow_{k-1}, \mid^\circ_k$  from  $\mathcal{P}(\partial)$ . Denote by  $N_k$  the set of all glyphs of types  $\Downarrow_{k-1}, \mid^\circ_k$  from  $\mathcal{P}(\partial)$ . We somehow fix bijections  $\psi_k : E_k \rightarrow N_k$ . Let  $\Psi$  coincides with  $\psi_k$  on  $E_k$ . The construction of  $\Psi$  is finished.

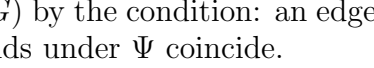
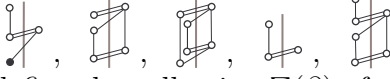
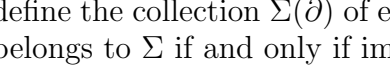
The glyphs of type  from  $\mathcal{P}(\partial)$  do not belong to the image of  $\Psi$ . Each glyph of the type , , , , is the image of a single vertex of  $\Gamma(\partial, G)$ . Each glyph of the type , , is the image of two vertexes. Let us define the collection  $\Sigma(\partial)$  of edges of  $\Gamma(\partial, G)$  by the condition: an edge belongs to  $\Sigma$  if and only if images of its ends under  $\Psi$  coincide.

Let us define  $s(\partial): V_\Sigma \rightarrow \{0, 2\}$  such that the set  $s^{-1}(2)$  is a preimage under  $\Psi$  of the set of all glyphs of the type . Obviously,  $(\Sigma(\partial), s(\partial))$  is a coloring of  $\Gamma(\partial, G)$ .

The coloring  $(\Sigma(\partial), s(\partial))$  depends only on choices of bijections  $\psi_k$ . Obviously, the polynomial  $P_{\Sigma(\partial), s(\partial)} = P(\partial)$  is independent of that choices.

*6.7. Decomposition of Morse polynomial.* It is easy to see looking on the construction of the polynomial  $P(\partial)$  that  $P(\partial)$  equals to the polynomial

$$\sum_k \left( \# \begin{array}{c} \circ \\ | \\ \circ \end{array} + \# \begin{array}{c} \circ \\ | \\ \circ \end{array} + \# \begin{array}{c} \circ \\ | \\ \circ \end{array} + \# \begin{array}{c} \circ \\ | \\ \circ \end{array} + \# \begin{array}{c} \circ \\ | \\ \circ \end{array} + \# \begin{array}{c} \circ \\ | \\ \circ \end{array} \right) t^k,$$

where  $\#$  is used to denote the number of corresponding glyphs in  $M$ -model of  $\partial$ .

Comparing this expression with the expression for Morse polynomial  $P_M(\partial, G)(t)$  (see sec. 3.8) from Proposition 3.4 we get the following theorem.

**Theorem 6.4.** *Morse polynomial  $P_M(\partial, G)(t)$  is canonically decomposed into the sum of the admissible polynomial  $P(\partial)$  and a polynomial  $(1+t)K(\partial)(t)$ , such that all coefficients of  $K(\partial)$  are nonnegative integers. Moreover*

$$K(\partial)(t) = \sum_k \left( \# \begin{array}{c} \circ \\ | \\ \circ \end{array} \right) t^k.$$

□

*6.8. Weak Morse inequalities.* Consider an  $M$ -differential  $\partial \in \mathcal{D}_{A,B,G}$ . Recall that we denote the number of vertexes of a graph  $\Gamma$  by  $v(\Gamma)$  and  $m(\Gamma)$  denotes the doubled maximal number of edges in a matching of  $\Gamma$ .

**Lemma 6.5.** *The number of elements in  $A \setminus (B \cup G_+)$  is greater than or equal to  $v(\Gamma(\partial, G)) - m(\Gamma(\partial, G)) = \min_{P \in \mathcal{P}_{\text{Adm}}(\partial, G)} P(1)$ .*

*The number of elements in  $A \setminus (B \cup G_+)$  of degree  $k$  is greater than or equal to  $\#B_k + \#C_k + \#D_k + \#E_k - \#A_{k-1}$ , where  $\#$  denotes the number of corresponding vertexes of  $\Gamma(\partial, G)$ .*



*Proof.* Indeed, the number  $\#A \setminus (B \cup G_+)$  equals to  $P(\partial)(1) + (1+t)K(\partial)(t)|_{t=1}$  by Theorem 6.4. The number  $P(\partial)(1)$  equals to the number of elements in  $V_{\Sigma(\partial)} \subset \#A \setminus (B \cup G_+)$ , where  $\Sigma(\partial)$  is a distinguished matching constructed above. By definition  $\#V_{\Sigma(\partial)} = v(\Gamma(\partial, G)) - 2\#\Sigma(\partial)$ . First claim of Lemma holds, since  $(1+t)K(\partial)(t)|_{t=1}$  is non-negative.

The number of elements of degree  $i$  in  $A \setminus (B \cup G_+)$  is greater than or equal to the coefficient of  $t^i$  of  $P(\partial)$  by Theorem refMorsedecomp. This coefficient, by definition of  $P(\partial)$ , equals to the number of vertexes from  $V_{\Sigma(\partial)}$  such that  $s(\partial)$  takes value  $k$ . The admissible map  $s(\partial)$  takes value  $k$  on each vertex of the type  $B_k, C_k, D_k$  or  $E_k$  from  $V_{\Sigma}$  by definition. The number of edges of any matching having one end in the union of vertexes of the type  $B_k, C_k, D_k$  or  $E_k$  is at most  $\#A_{k-1}$  since all such edges start at vertexes from  $A_{k-1}$ . It proves the second claim.  $\square$



*6.9. All colorings are induced by an  $M$ -differential.* An  $M$ -differential  $\partial \in \mathcal{D}_{A,B,G}$  generates a graph  $\Gamma(\partial, G)$  and distinguished coloring  $(\Sigma(\partial), s(\partial))$ . Consider (another) a coloring  $(\Sigma, s)$  of  $\Gamma(\partial, G)$ .

**Lemma 6.6.** *There exists linearly ordered set  $A'$  containing  $B$  (the order and grading induced from  $A'$  on  $B$  coincides with the order and grading induced from  $A$ ) and differential  $\partial' \in \mathcal{D}_{A',B,G}$  such that*



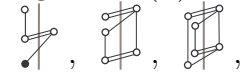

- (1)  $\partial_B \sim \partial'_B$ ,  $H(\partial) = H(\partial')$ ,  $H_*(\mathcal{M}_{A,\partial}) \approx H_*(\mathcal{M}_{A,\partial'})$ ,  
 $H_*(\mathcal{M}_{A,\partial}, \mathcal{M}_{B,\partial_B}) \approx H_*(\mathcal{M}_{A',\partial'}, \mathcal{M}_{B,\partial'_B})$ ;
- (2)  $M$ -model of  $\partial'$  does not contain glyphs of type  $\begin{array}{c} | \\ \circ \\ | \end{array}$ ;
- (3)  $(\Sigma, s) = (\Sigma(\partial'), s(\partial'))$  after a suitable natural isomorphism of Lemma 6.1.

*Proof.* Consider firstly the case of empty matching  $\Sigma$  and zeroes admissible map  $s$ . We will assume that  $\partial$  is totally decomposable. To construct  $\partial'$  we change glyphs in  $\partial$  as follows. Edges in  $\Sigma(\partial)$  are

in one-to-one correspondence with glyphs of types ,

 and . We replace somehow each such a glyph by two glyphs:

 by  and ,  by  and ,  by  and ,

 by  $\begin{array}{c} | \\ \circ \end{array}$  and  and  by two . Vertexes in  $s(\partial)^{-1}(2)$  are

in one-to-one correspondence with glyphs of type . We replace

somehow each of these glyphs by a glyph of the type . At last,

we cancel all glyphs of type  $\begin{array}{c} | \\ \circ \\ | \end{array}$ . Note that this operation on  $\partial$  is not unique, since an order on  $A'$  is not uniquely defined. However,

the resulting differential  $\partial_{\emptyset}$ , obviously, has the same graph and empty distinguished matching and zeroes admissible map.

To obtain the differential with an arbitrary coloring we change the glyphs of by  $\partial_{\emptyset}$  by obvious “inverse” rule to the rule described above. Obviously, this operation does not change the graph and homological properties of the differential.  $\square$

## 7. PROOF OF GENERALIZED MORSE INEQUALITIES.

### COMBINATORIAL STRUCTURE ON THE SET OF CRITICAL POINTS.

*7.1. Construction of the set  $\mathcal{P}_{\mathbb{E}}(f, M)$ .* Starting from the topological data of sec. 0.4 we construct the set  $\mathcal{P}_{\mathbb{E}}(f, M)$  of sec. 0.1. We continue in notations of sec. 0.4.

Let  $f$  be a strong Morse germ on a boundary  $\partial M$  of the compact manifold  $M$ .

Consider the graded finite set  $B_f = \{c_1 < \dots < c_N\}$  of critical values of function  $g = f|_{\partial M}$ , grading is a mapping to  $\mathbb{Z}$ ,  $c_i \mapsto \deg(c_i)$ , where  $\deg(c_i)$  is the Morse index of  $g$  in the corresponding critical point (see sec. 2.9). Denote by  $G_f \subset B_f$  the set of values of  $g$  at all outward critical points of  $g$ . This construction depends on the part (2) of the topological data only.

Denote by  $\partial M^a$  the sublevel set  $\{x \in \partial M | g(x) \leq a\}$ . We say that two critical values  $c_i < c_j$  of  $g$  generate a pair if

$$\begin{aligned} \dim H_*(\partial M^{a_{j+1}}, \partial M^{a_i}) &= \dim H_*(\partial M^{a_{j+1}}, \partial M^{a_{i+1}}) - 1 = \\ &= \dim H_*(\partial M^{a_j}, \partial M^{a_{i+1}}) = \dim H_*(\partial M^{a_j}, \partial M^{a_i}) - 1. \end{aligned}$$

It turns out, that any critical value of  $g$  could be a member of at most one pair and  $(c_i, c_j)$  is such a pair only if  $\deg(c_j) = \deg(c_i) + 1$ . Thus,  $B_f$  is decomposed into disjoint pairs and single elements. This decomposition uses the part (3) of the topological data only.

We define  $H_f \subset B_f$  to be the set of all boundary homologically essential critical values of  $g$  (see sec. 2.10). Definition of a boundary homologically essential critical value require the part (4) of the topological data only. It turns out that set  $H_f$  of all boundary homologically essential critical values is a subset of the subset of all single critical values in  $B_f$ .

Let us define a number  $d_k$  to be equal the dimension of the kernel of the connecting homomorphism  $H_k(M, \partial M) \rightarrow H_{k-1}(M)$ . Consider the graph  $\Gamma(B_f, G_f, H_f, (d_k)_{k \in \mathbb{Z}})$  constructed in sec. 6.1, 6.2. We define  $\Gamma_{\mathbb{E}}(f, M)$  to be equal  $\Gamma(B_f, G_f, H_f, (d_k)_{k \in \mathbb{Z}})$  and  $\mathcal{P}_{\mathbb{E}}(f, M)$  from Theorem 0.1 to be  $\mathcal{P}_{\text{Adm}}(B_f, G_f, H_f, (d_k)_{k \in \mathbb{Z}})$ , which is defined in 6.4.

*7.2. Examples.* Consider a germ  $f$  along the boundary of closed interval  $M$  from Sec. 0.3. The corresponding graph  $\Gamma_{\mathbb{E}}(f, M)$  has two vertexes: vertex of the type  $C_0$  and vertex of the type  $D_1$ . Hence,  $\Gamma_{\mathbb{E}}(f, M)$

has no edges and  $\mathcal{P}_{\mathbb{E}}(f, M) = \{1 + t\}$ . For a closed manifold  $M$  the graph  $\Gamma_{\mathbb{E}}(f, M)$  has no vertexes of types A, B, C and D, the number of vertexes of the type  $E_k$  is equal  $b_k^{\mathbb{E}}(M)$ . Thus  $\mathcal{P}_{\mathbb{E}}(f, M)$  consists of a single polynomial, which is a Poincaré polynomial of  $M$ .

7.3. Let us prove that the combinatorial structure on  $B_f$  introduced above is sound. Let  $F$  be a strong Morse function extending the germ  $f$ . Consider a Morse chain  $\mathbf{M}$  (see sec. 2.3) of the function  $F$ , containing a chain of inclusions of  $CW$ -pairs  $(X_0, Y_0) \subset \dots \subset (X_{2N}, Y_{2N})$  and a filtered homotopy equivalence  $h: (M, \partial M) \rightarrow (X, Y)$ . Let  $\mathcal{M}_{A_F, B_F, \partial}$  be the corresponding algebraic model (see sec. 2.9) (The set  $B_F$  is in a natural one-to-one correspondence with  $B_f$ ). The map  $h$  induces an isomorphisms between singular homologies of a pair  $(F_{a_i}^{\partial}, F_{a_j}^{\partial})$  and cellular homologies of a corresponding pair  $(Y_{2i}, Y_{2j})$  for any  $i \geq j$ . Last homologies are exactly the homologies characterizing  $\partial$ -pairs by Lemma 4.2. Thus, any  $\partial_{B_F}$ -pair naturally is a pair defined in sec. 7.1 and vice versa.

Analogous consideration shows that boundary homologically essential critical values coincide with the values of  $F$  on  $\partial$ -boundary homologically essential elements of  $B_F$  defined in sec. 3.1. By Lemma 4.3 any homologically essential critical value is not a member of  $\partial$ -pair.

Applying considerations of Lemma 6.2 it is easy to see that numbers  $d_k$  depend on the part (1) of the topological data only. Therefore, combinatorial structure of sec. 7.1 is well defined.

????????????????Skazat', chto graphy sovpadayut!!! Moreover, the graph  $\Gamma_{\mathbb{E}}()$

7.4. *Algebraic model.* Let  $F$  be a strong Morse function on a compact manifold  $M$ . Consider an algebraic model (with coefficients in  $\mathbb{E}$ )  $\mathcal{M}_{A_F, B_F, \partial}$  of  $F$ , let  $G_F$  be a set of all outward critical points of  $F|_{\partial M}$ .

**Lemma 7.1.** *Each element of  $G_F$  is  $\partial$ -trivial element.*

*Proof.* Consider  $b \in G_F$ . Let  $F(b) = c_i$  in the notations of sec. 2.3. An element  $b_+$  next to  $b$  in  $A_F$  does not belong to  $B_F$  by the definition of  $A_F$ . The element  $b_+$  corresponds to a cell attaching to the pair  $(F_{a_{i-1}} \cup F_{a_i}^{\partial}, F_{a_i}^{\partial})$  by Proposition 2.1(3). By Proposition 2.1(3) the set  $F_{a_{i-1}}$  is a strong deformation retract of  $F_{a_i}$ . Thus  $H_*(F_{a_i}, F_{a_{i-1}}) = 0$  and hence  $\partial(b_+)$  contains  $b$ .  $\square$

The following Lemma deduces immediately from Lemma 7.1.

**Lemma 7.2.** *Let  $f$  be a strong Morse germ and  $F$  be a strong Morse function extending  $f$ . For any algebraic model  $\mathcal{M}_{A_F, B_F, \partial}$  with  $\mathbb{E}$ -coefficients the graph  $\Gamma(\partial, G_F)$  is naturally isomorphic to  $\Gamma_{\mathbb{E}}(f, M)$ .*



*Proof.* Definitions for these graphs coincide up to replacement  $B_f$  by  $B_F$ ,  $G_f$  by  $G_F$  and  $H_f$  by  $H(\partial)$ .  $\square$

We summarize useful properties of an algebraic model in the following Proposition.

**Proposition 7.3.** *Let  $F$  be a strong Morse function on  $(M, \partial M)$ ,  $M_{A_F, B_F, G_F, \partial}$  be an algebraic model of  $F$ .*

- (1) *For any  $i$   $H_i(\mathcal{M}_{A_F, \partial}, \mathcal{M}_{B_F, \partial_{B_F}}) = H_i(M, \partial M)$ ,  $H_i(\mathcal{M}_{B_F, \partial_{B_F}}) = H_i(\partial M)$ ,  $H_i(\mathcal{M}_{A_F, \partial}) = H_i(M)$ ;*
- (2) *An  $M$ -complex  $\mathcal{M}_{B_F, \partial_{B_F}}$  is an algebraic model for a function  $F|_{\partial M}$  and, therefore, depends (up to the equivalence) on that function only;*
- (3) *Any element of the set  $G_F \subset B_F$ , consisting of all outward critical points is  $\partial$ -trivial;*
- (4) *The set  $H_F \subset B_F$ , consisting of all boundary homologically essential critical points of the function  $F|_{\partial M}$ , coincides with the set of all boundary homologically essential elements of the pair  $M_{A_F, B_F, \partial}$*
- (5) *An algebraic model of a function  $F$  is naturally isomorphic to a suitable algebraic model of a function  $\psi \circ F \circ \varphi$ , where  $\psi: \mathbb{R} \rightarrow \mathbb{R}$  is a preserving orientation diffeomorphism and  $\varphi: M \rightarrow M$  is a diffeomorphism. The isomorphism class of an algebraic model preserves while  $F$  continuously deforms in the space of all strong Morse functions.  $\square$*

*7.5. Combinatorial structures.*  $M$ -differential  $\partial$  of  $\mathcal{M}_{A_F, B_F, \partial}$  belongs to  $\mathcal{D}_{A_F, B_F, G_F}$  by Lemma 7.1, therefore we can apply  $M$ -model theorem to it. The corresponding  $M$ -model  $\mathcal{P}(\partial)$  is independent from a choice of an algebraic model by Statement 2.9.

Each critical point of the function  $F$  is a basic element of a unique glyph of types  from  $\mathcal{P}(\partial)$ . We define  $\text{Add}_{\mathbb{E}}(F) \subset \text{Crit}(F)$  mentioned in sec. 0.1 to be all critical points of  $F$  which are basic elements of glyphs of the type . The set  $\text{Top}_{\mathbb{E}}(F)$  is, by definition, a complement to  $\text{Add}_{\mathbb{E}}(F)$ . The set  $\text{Add}_{\mathbb{E}}(F)$  is naturally decomposed into disjoint union of pairs of critical points having consecutive Morse indexes, since the basis of a glyph of the type  consists of two elements of consecutive degrees. The set  $\text{Top}_{\mathbb{E}}(F)$  carries natural disjoint decomposition according to type and degree of corresponding glyphs.

*7.6. Proof of generalized Morse inequalities.* *Theorems 0.1, 0.1, 1.1 and 0.2.* Let us prove Theorem 0.1.

Let  $F$  be a strong Morse function  $F$  on  $M$  extending a strong Morse germ. Let  $\partial$  be a differential of an algebraic model of  $F$ . Decomposition of Theorem 6.4 of Morse polynomial of  $\partial$  into the

sum of two polynomials coincides with the decomposition of the Morse polynomial  $P(F)$  corresponding to the decomposition  $\text{Crit}(F) = \text{Top}_{\mathbb{E}}(F) \cup \text{Add}_{\mathbb{E}}(F)$ . First summand belongs to the finite set  $\mathcal{P}_{\mathbb{E}}(f, M)$  constructed above. Theorem 0.1 is proved.

Number of critical points (of index  $i$ ) of a Morse function equals to the value of its Morse polynomial at 1 (coefficient of  $t^i$  in its Morse polynomial, respectively). Any Morse function having a strong Morse germ along the boundary could be slightly perturb without changing its critical points and its germ along the boundary to the strong Morse function. Therefore, Theorem 0.2 is a corollary of Theorem 0.1.

Theorems 1.1 and 0.2 are obvious corollaries of Lemma 6.5 applied to an algebraic model of suitably perturbed Morse function.

*7.7. Remarks.* (1). Consider the space of all functions extending a given strong Morse germ. Let  $F(t)_{t \in [-1, 1]}$  be a generic path realizing a “birth” of two critical points at  $t = 0$  and such that for any  $t \neq 0$   $F(t)$  is a strong Morse function. Consider a natural injection  $i: \text{Crit}(F(-1)) \rightarrow \text{Crit}(F(1))$  generated by a unique continuous extension of critical points of  $F(t)$  along the path  $F(t)_{t \in [-1, 1]}$ . One can show that newborn pair of critical points lies in the additional subset and forms a pair in it, moreover, an image under  $i$  of  $\text{Top}_{\mathbb{E}}(F(-1))$  is  $\text{Top}_{\mathbb{E}}(F(1))$  and an image of any pair from  $\text{Add}_{\mathbb{E}}(F(-1))$  is a pair in  $\text{Add}_{\mathbb{E}}(F(1))$ .

(2). The definition of sets  $\text{Top}_{\mathbb{E}}(F)$  and  $\text{Add}_{\mathbb{E}}(F)$  is a product of  $M$ -model theorem applied to a differential of an algebraic model of  $F$ . One can vary, in a natural way,  $M$ -model theorem and it leads to another admissible and topologically essential sets, another decomposition of Morse polynomial of the function  $F$  which are also “canonical”. For example, consider the map  $\mathcal{P}_{\min}$  from sec. 5.5 and apply it to a differential from an algebraic model. The resulting minimal differential contains direct summands, which are glyphs of

$\begin{array}{c} \circ \\ | \\ \circ \end{array}$ . One can call critical points from the union of bases of such summands by additional critical points and its complement in the set  $\text{Crit}(F)$  by topologically essential critical points. Let us denote this sets as  $\widetilde{\text{Add}}_{\mathbb{E}}(F)$  and  $\widetilde{\text{Top}}_{\mathbb{E}}(F)$  correspondingly. The disjoint decomposition  $\text{Crit}(F) = \widetilde{\text{Top}}_{\mathbb{E}}(F) \cup \widetilde{\text{Add}}_{\mathbb{E}}(F)$  leads to decomposition of Morse polynomial into two summands. It is possible to explicitly construct the corresponding finite set  $\widetilde{\mathcal{P}}_{\mathbb{E}}(f, M)$  and the summand generated by  $\widetilde{\text{Top}}_{\mathbb{E}}(F)$  belongs to  $\widetilde{\mathcal{P}}_{\mathbb{E}}(f, M)$ .

One can show that newborn pair from a family of functions of the first remark is pair of additional points (in that local sense) also. So, that varying of the definition is natural. But, obviously,  $\widetilde{\text{Add}}_{\mathbb{E}}(F) \subset \text{Add}_{\mathbb{E}}(F)$  and each pair from  $\widetilde{\text{Add}}_{\mathbb{E}}(F)$  is a pair from  $\text{Add}_{\mathbb{E}}(F)$ . Moreover,  $\widetilde{\mathcal{P}}_{\mathbb{E}}(f, M) \subset \mathcal{P}_{\mathbb{E}}(f, M)$  and any polynomial from

$\widetilde{\mathcal{P}_{\mathbb{E}}}(f, M)$  is a sum of a polynomial from  $\mathcal{P}_{\mathbb{E}}(f, M)$  with a summand  $(1+t)k(t)$ , where all coefficients of  $k$  are non-negative. Therefore, the resulting Morse-type inequalities in Arnol'd problem coincide with inequalities given by  $M$ -model theorem.

Instead of considering  $\mathcal{P}_{\text{ind}}$  one can consider a composition of  $\mathcal{P}_{\text{ind}}$  with subsequent applying of  $\mathcal{P}$  to direct summands of certain types in distinguished differentials. It leads to another additional and topologically essential sets.

(3). Let us describe a manifold  $M$  and a strong Morse germ  $f$  along  $\partial M$  such that  $\mathcal{P}_{\mathbb{E}}(f, M)$  consists from more than one element and there exists strong Morse extensions  $F_1$  and  $F_2$  such that polynomials  $P_{\mathbb{E}}(F_1)$  and  $P_{\mathbb{E}}(F_2)$  are not coincide. Such a situation does not realize for  $\dim M = 1$ , the simplest example of such a manifold is two-dimensional disk.

Consider a strong Morse function  $F$  with two local maximums, one saddle and one minimum on the sphere  $S^2$ . Let  $U$  be sufficiently small open round neighborhood of a saddle. Manifold  $M$  is a complement of  $U$ . For a generic  $U$  the germ of  $F$  along  $\partial U = \partial M$  is a strong Morse germ. Let  $f$  be such a germ. One can show that  $\mathcal{P}_{\mathbb{E}}(f, M) = \{2+t^2, 1+2t^2\}$  for any  $\mathbb{E}$ . Obviously,  $P_{\mathbb{E}}(F|_M) = 1+2t^2$  and  $P_{\mathbb{E}}(H) = 2+t^2$ , where  $H$  is an extension of  $f$  with two local minimums and one maximum.

## 8. CLASSICAL AND GENERALIZED MORSE INEQUALITIES. ARNOLD'S EXAMPLE.

In this section we prove that generalized Morse inequalities of Theorems 0.1 and 1.2 are not weaker than classical Morse inequalities consider Arnold example??? in details.

*8.1. Classical and generalized Morse inequalities.* Let us fix a strong Morse germ  $f$  along the boundary  $\partial M$  of a compact manifold  $M$ . We show that for any  $P \in \mathcal{P}_{\mathbb{E}}(f, M)$  there exists a polynomial  $Q$  with nonnegative integer coefficients such that  $P(t) = P_{\mathbb{E}}(M)(t) - P_-(f, M)(t) + (1+t)Q(t)$ .

A polynomial  $P$  is, by definition, generated by a coloring  $(\Sigma, s)$  of the graph  $\Gamma_{\mathbb{E}}(f, M)$ ,  $P = P_{\Sigma, s}$ . The graph  $\Gamma_{\mathbb{E}}(f, M)$  by Lemma 7.2 naturally isomorphic to a graph  $\Gamma(\partial, G_F)$ , where  $\partial$  is a differential of an algebraic model  $\mathcal{M}_{A_F, B_F, \partial}$  of a strong Morse function extending  $F$ .

By Lemma 6.6 applying to  $\partial$  there exists a linearly ordered set  $A'$  containing  $B_f$  and an  $M$ -differential  $\delta \in \mathcal{D}_{A', B_f, G_f}$ , such that  $(\Sigma, s)$  is a coloring generated by  $\delta$  (see sec. 6.6) and homologies of  $\delta$  coincide with homologies of  $M$ . We may assume that  $\delta$  is totally decomposable and use its glyphs to calculate polynomials  $P_{\mathbb{E}}(M)(t) - P_-(f, M)(t)$  and  $P$ . The polynomial  $P_{\mathbb{E}}(M)(t) - P_-(f, M)(t)$  equals to

$$\begin{aligned}
 & \sum_k \left( \# \begin{array}{c} \circ \\ | \\ \circ \end{array}_{k-1} + \# \begin{array}{c} \circ \\ | \\ \circ \\ | \\ \circ \end{array}_{k-1} + \# \circ \big|_k + \# \big| \circ_k + \# \begin{array}{c} \circ \\ | \\ \circ \end{array}_k \right) t^k - \\
 & - \left( \sum_k \left( \# \begin{array}{c} \circ \\ | \\ \circ \end{array}_{k-1} + \# \begin{array}{c} \circ \\ | \\ \circ \\ | \\ \circ \end{array}_{k-1} + \# \begin{array}{c} \circ \\ | \\ \circ \end{array}_{k-1} + \# \begin{array}{c} \circ \\ | \\ \circ \\ | \\ \circ \end{array}_{k-1} + \# \begin{array}{c} \circ \\ | \\ \circ \\ | \\ \circ \end{array}_k + \# \circ \big|_k + \right. \\
 & \left. + \# \begin{array}{c} \circ \\ | \\ \circ \end{array}_k \right) t^k + \sum_k \left( \# \circ \big|_k + \# \begin{array}{c} \circ \\ | \\ \circ \\ | \\ \circ \end{array}_k + \# \begin{array}{c} \circ \\ | \\ \circ \end{array}_k \# \begin{array}{c} \circ \\ | \\ \circ \\ | \\ \circ \end{array}_{k-1} \right) t^k (1+t) = \\
 & = \sum_k \left( \# \big| \circ_k + \# \begin{array}{c} \circ \\ | \\ \circ \end{array}_k - \# \begin{array}{c} \circ \\ | \\ \circ \end{array}_{k-1} - \# \begin{array}{c} \circ \\ | \\ \circ \\ | \\ \circ \end{array}_{k-1} - \# \begin{array}{c} \circ \\ | \\ \circ \\ | \\ \circ \end{array}_k - \# \begin{array}{c} \circ \\ | \\ \circ \end{array}_k \right) t^k - \\
 & \quad - \sum_k \left( \# \circ \big|_k + \# \begin{array}{c} \circ \\ | \\ \circ \\ | \\ \circ \end{array}_k + \# \begin{array}{c} \circ \\ | \\ \circ \end{array}_k + \# \begin{array}{c} \circ \\ | \\ \circ \\ | \\ \circ \end{array}_{k-1} \right) t^k (1+t),
 \end{aligned}$$

while  $P$  equals to:

$$P(t) = \sum_k \left( \# \begin{array}{c} \circ \\ | \\ \circ \end{array}_k + \# \big| \circ_k + \# \begin{array}{c} \circ \\ | \\ \circ \end{array}_k + \# \begin{array}{c} \circ \\ | \\ \circ \\ | \\ \circ \end{array}_{k-1} + \# \begin{array}{c} \circ \\ | \\ \circ \end{array}_{k-1} + \# \begin{array}{c} \circ \\ | \\ \circ \\ | \\ \circ \end{array}_{k-2} \right) t^k.$$

The difference  $P - (P_{\mathbb{E}}(M) - P_-(F, dM))$  is equal, obviously:

$$\begin{aligned}
 & \sum_k \left( \# \begin{array}{c} \circ \\ | \\ \circ \end{array}_k + \# \begin{array}{c} \circ \\ | \\ \circ \\ | \\ \circ \end{array}_k + \# \begin{array}{c} \circ \\ | \\ \circ \end{array}_k + \# \begin{array}{c} \circ \\ | \\ \circ \\ | \\ \circ \end{array}_{k-1} \right) (t^k + t^{k+1}) + \\
 & \quad + \sum_k \left( \# \circ \big|_k + \# \begin{array}{c} \circ \\ | \\ \circ \\ | \\ \circ \end{array}_k + \# \begin{array}{c} \circ \\ | \\ \circ \end{array}_k + \# \begin{array}{c} \circ \\ | \\ \circ \\ | \\ \circ \end{array}_{k-1} \right) t^k (1+t).
 \end{aligned}$$

Hence, generalized Morse inequalities of Theorem 0.1 are not weaker than classical Morse inequalities.

Consider now classical weak inequalities  $m_k(F) \geq b_k^{\mathbb{E}}(M) - m_k^{\partial}(f, M)$  and inequalities of Theorem 1.2. Let  $\delta$  be a totally decomposable  $M$ -differential calculating the homology of  $M$  generating coloring of the graph  $\Gamma_{\mathbb{E}}(f, M)$  with empty matching and zeroes admissible map. Such a differential was constructed in the proof of Lemma 6.6. By

construction  $\delta$  has no glyphs of types  $\begin{array}{c} \circ \\ | \\ \circ \end{array}$ ,  $\begin{array}{c} \circ \\ | \\ \circ \\ | \\ \circ \end{array}$ ,  $\begin{array}{c} \circ \\ | \\ \circ \end{array}$ ,  $\begin{array}{c} \circ \\ | \\ \circ \end{array}$ ,  $\begin{array}{c} \circ \\ | \\ \circ \\ | \\ \circ \end{array}$  and  $\begin{array}{c} \circ \\ | \\ \circ \end{array}$ .

In terms of glyphs of  $\delta$ :

$$\begin{aligned}
b_k^{\mathbb{E}}(M) &= \# \circ \Big|_k + \# \Big|_k^\circ + \# \begin{array}{c} \diagup \\ \diagdown \end{array} \Big|_k, \\
m_k^{\partial}(f, M) &= \# \circ \Big|_k + \# \circ \Big|_{k-1} + \# \circ \Big|_k + \# \begin{array}{c} \bullet \\ \diagup \end{array} \Big|_k + \# \begin{array}{c} \circ \\ \diagup \end{array} \Big|_k + \# \begin{array}{c} \circ \\ \diagdown \end{array} \Big|_{k-1}, \\
\#B_k &= \# \begin{array}{c} \diagup \\ \diagdown \end{array} \Big|_k = \# \begin{array}{c} \circ \\ \diagup \end{array} \Big|_k, & \#C_k &= \# \begin{array}{c} \diagup \\ \diagdown \end{array} \Big|_k = \# \begin{array}{c} \circ \\ \diagdown \end{array} \Big|_k, \\
\#D_k &= \# \begin{array}{c} \diagup \\ \diagdown \end{array} \Big|_k = \# \begin{array}{c} \bullet \\ \diagup \end{array} \Big|_k, \#E_k = \# \Big|_k^\circ, \#A_{k-1} = \# \begin{array}{c} \circ \\ \diagdown \end{array} \Big|_{k-1} = \# \begin{array}{c} \circ \\ \diagdown \end{array} \Big|_{k-1}.
\end{aligned}$$

Therefore, the difference

$$\#B_k + \#C_k + \#D_k + \#E_k - \#A_{k-1} - (b_k^{\mathbb{E}}(M) - m_k(f, \partial M))$$

equals to

$$2\# \begin{array}{c} \bullet \\ \diagup \end{array} \Big|_k + 2\# \begin{array}{c} \circ \\ \diagdown \end{array} \Big|_{k-1} + \# \circ \Big|_k + \# \circ \Big|_{k-1} + \# \begin{array}{c} \diagup \\ \diagdown \end{array} \Big|_k + \# \begin{array}{c} \bullet \\ \diagup \end{array} \Big|_k,$$

and hence non-negative. It proves that inequalities of Theorem 1.2 are not weaker than classical weak Morse inequalities.

## 8.2. Arnold's example.

The following statement claims that inequalities of Theorem 0.1 gives good result for Arnold's example (see sec.???)

**Statement 8.1.** *Let  $M^{n+1}$  ( $n > 0$ ) be a closed manifold,  $F$  be a strong Morse function on  $M^{n+1}$  containing all its critical points in an embedded closed ball  $B^{n+1} \subset M^{n+1}$ . Suppose, that a germ of  $F$  along  $\partial B^{n+1} = S^n$  is a strong Morse germ.*

*For any  $P \in \mathcal{P}_{\mathbb{E}}(f, B^{n+1})$  there exists a polynomial  $Q$  with non-negative coefficients such that*

$$P(t) = P_{\mathbb{E}}(M) + (1+t)Q(t).$$

*Proof.* We denote by  $M_1$  the manifold  $(M^{n+1} \setminus B^{n+1}) \cup S^n$ , by  $\tilde{F}$  we denote the restriction  $F|_{M_1}$ ,  $f$  denotes a germ of  $F$  along  $S^n$  and  $h$  denotes the restriction  $F|_{S^n}$ . Points of global maximum and global minimum of  $h$  are only homologically essential critical point of  $h$  since the homologies of  $S^n$  are two-dimensional.

The point of global maximum (minimum) of  $h$  is inward (outward, respectively) directed for  $f$  (considered as a germ on the boundary of  $B^{n+1}$ ), since  $\tilde{F}$  has no critical points. All other critical points of function  $h$  is decomposed into disjoint pairs. Hence, the set  $V_{\Gamma}$  of all vertexes of  $\Gamma = \Gamma_{\mathbb{E}}(f, B^{n+1})$  contains one vertex of type  $\begin{array}{c} \diagup \\ \diagdown \end{array} \Big|_{n+1}$ , corresponding to the global maximum of  $h$ , one vertex of type  $\begin{array}{c} \diagup \\ \diagdown \end{array} \Big|_0$ , corresponding to the global minimum of  $h$ , and all other vertices are of types A or B, since for  $B^{n+1}$  all  $d_k$  are zero.







Let  $(\Sigma, s)$  be a coloring of  $\Gamma$ . Recall, that we denote by  $V_{\Sigma}$  the complement to the set of ends of edges from  $\Sigma$ . Consider a linearly









ordered set  $A$  containing  $B_f$  and totally decomposable differential  $\delta \in \mathcal{D}_{A, B_f, G_f}$  constructed in Lemma 6.6 such that  $\delta$  does not contain glyphs  and generates  $(\Sigma, s)$ . By definition





$$P(t) = \sum_{a \in A \setminus (B_f \cup (G_f)_+)} t^{\deg(a)} = \sum_{v \in V_\Sigma} t^{\deg(v) + s(v)}.$$



We will explicitly split  $\sum_{a \in A \setminus (B_f \cup (G_f)_+)} t^{\deg(a)}$  into a sum  $P_{\mathbb{E}}(M) + (1 + t)Q(t)$ .

We note that  $\delta$  does not contain glyphs of types , ,  and . Indeed,  is impossible, since it must contain global maximum, which is the unique boundary homologically essential critical point, but it contradicts maximality. Analogously, glyph of type  must contain global minimum, which contradicts with minimality.

Glyphes  and  are impossible, since they contribute to relative homology, but relative homology of disk are of dimension one and contains in a unique glyph  generated by global maximum of  $h$ . Therefore, vertexes corresponding to global maximum and global minimum of  $h$  belong to  $V_\Sigma$ .

We will describe  $V_\Sigma$  in terms of the following mapping  $n_\Sigma: V_\Gamma \rightarrow V_\Gamma$ . We set  $n_\Sigma(v) = v$  for vertices generated by global maximum and global minimum of  $h$ . Each inward (outward) critical point of  $f|_{S^n}$  relatively  $B^{n+1}$  is outward (inward, respectively) critical point of  $f|_{S^n}$  relatively  $M_1$ . Hence, there is a natural correspondence between vertexes of type  in  $\Gamma$  and vertexes of type  in  $\Gamma(f, M_1)$ . Similarly there is a natural correspondence between vertexes of type  in  $\Gamma$  and vertexes of type  in  $\Gamma(f, M_1)$ .

We define  $n_\Sigma(v)$  for a vertex  $v$  of the type . The vertex  $v$  corresponds to a vertex  $u_1 \in V_{\Gamma(f, M_1)}$  of type  in  $\Gamma(f, M_1)$ . Since  $\tilde{F}$  has no critical points,  $u_1$  is a part of a glyph of type  in  $M$ -model of  $\tilde{F}$ . Consider a vertex  $u_2 \in V_{\Gamma(f, M_1)}$  of the type  contributing in this glyph. This vertex corresponds to a vertex  $u \in V_\Gamma$  of the type . We set  $n_\Sigma(v) = u$ .

If  $v$  is a vertex of the type  then we set  $n_\Sigma(v) = v$  if  $v \in V_\Sigma$ . If  $v \notin V_\Sigma$  then  $v$  contributes in a glyph of type  from  $\delta$ . This glyph contains a vertex  $u \in V_\Gamma$  of the type . We set  $n_\Sigma(v) = u$ .

Note, that if  $n_\Sigma(v) \neq v$  and  $v = (b_i, b_j)$ ,  $i > j$ , then  $n_\Sigma(v) = (b_m, b_n)$  for some  $n, m$  such that  $i > m > n > j$ . It implies that  $n_\Sigma$  does not have periodic vertexes of (minimal) period greater than one. The second remark is the following: preimage of a vertex  $v$  under the mapping  $\Sigma$  contains at most one vertex differs with  $v$ . Therefore,  $V_\Gamma$  decomposes into the disjoint union of following *chains*. We call an ordered subset  $\{v_1, \dots, v_k\}$   $\Sigma$ -chain if either  $k = 1$ ,  $v_1 = n_\Sigma(v_1)$  and  $n_\Sigma^{-1}(v_1) = \{v_1\}$  or  $k > 1$ ,  $n_\Sigma^{-1}(v_1) = \emptyset$ ,  $n_\Sigma(v_i) = v_{i+1} \neq v_i$  for  $i < k$  and  $n_\Sigma(v_k) = v_k$ , we say that  $k$  is a length of a  $\Sigma$ -chain. We conclude, that  $V_\Gamma$  decomposes into the disjoint union of  $\Sigma$ -chains.

Each  $\Sigma$ -chain contributes one or two monomials into the  $\sum_{a \in A \setminus (B_f \cup (G_f)_+)} t^{\deg(a)}$ . Global maximum and minimum generates  $\Sigma$ -chains of length 1 and these chains contributes monomials  $t^{n+1}$  and  $t^0$  into the  $P(t) = \sum_{a \in A \setminus (B_f \cup (G_f)_+)} t^{\deg(a)}$ . Consider now all other  $\Sigma$ -chains

only. For any vertex  $v$  of the type  $\Downarrow_k$  for some  $k$ ,  $n_\Sigma(v) \neq v$ . Thus, each of chains under consideration ends at a vertex from  $V_\Sigma$  and this vertex

corresponds to a glyph of the type  in  $\delta$ . Consider now all chains starting from a vertex of  $\Downarrow_{k+1}$ . Each this chain contributes an exactly one monomial  $t^{k+1}$  into  $P(t)$ . Suppose now that  $M^{n+1}$  is orientable either  $\text{char}(\mathbb{E}) = 2$ . In that case the global maximum of  $h$  contributes

in a glyph of the type  of  $M$ -model of  $\tilde{F}$ , and  $M$ -model of  $\tilde{F}$  does

not contain glyphes of the type . Hence vertexes of type  $\Downarrow_{k+1}$  which starts  $\Sigma$ -chains are in one-to-one correspondence with vertexes







of type  $\Downarrow_k$  of  $\Gamma(f, M_1)$  which are contributes in glyphes of types 

and  only. The number of glyphes of type  $\Downarrow_k$  in  $M$ -model of  $\tilde{F}$  equals to  $b_{k+1}^{\mathbb{E}}(M)$  for  $k \in \{0, n-1\}$ . Hence  $\Sigma$ -chains starting from vertexes corresponding to these glyphes contribute  $\sum_{i=1}^n b_i^{\mathbb{E}}(M)$

into  $P(t)$ . Each glyph of the type  in  $M$ -model of  $\tilde{F}$  naturally generates two  $\Sigma$ -chains and they contributes a  $t^l + t^{l+1} = t^l(1+t)$  into  $P(t)$  for some  $l$ . Hence, the common contribution into  $P(t)$  of  $\Sigma$ -chains starting from vertexes of the type  $\Downarrow$  is  $\sum_{i=1}^n b_i^{\mathbb{E}}(M) + (1+t)K(t)$ , where all coefficients of  $K$  are non-negative. Hence,  $P(t)$  decomposes into the sum:

$$P(t) = t^{n+1} + t^0 + \sum_{i=1}^n b_i^{\mathbb{E}}(M) + (1+t)K(t) + R(t),$$

where  $R(t)$  is a contribution of  $\Sigma$ -chains starting from a vertexes of type  $\Downarrow$ . Each such a chain starts from either a vertex from  $V_\Sigma$  (those







vertexes, and therefore chains, corresponds to glyphs of types  and  in  $\delta$ ) or from an ends of edges in  $\Sigma$  which are generate glyphs of the type  in  $\delta$ . Each chains corresponding to  or  contains two elements of consecutive degree in  $A \setminus (B_f \cup (G_f)_+)$  and, therefore, contributes  $t^l + t^{l+1}$  for some  $l$  into  $P(t)$ . Each glyph of the type  in  $\delta$  generates two  $\Sigma$ -chains and those chains contains two elements of consecutive degree in  $A \setminus (B_f \cup (G_f)_+)$  also. Hence,  $R(t) = (1+t)N(t)$  where all coefficients of  $N$  are non-negative.

Remaining case  $M^{n+1}$  is non-orientable and  $\text{char}(\mathbb{E}) \neq 2$  is slightly different. In that case  $M$ -model of  $\tilde{F}$  contains exactly one glyph of the type  (containing the global maximum of  $h$ ). This glyph generate one  $\Sigma$ -chain which contributes  $t^n$  into  $P(t)$ . Hence, in that case

$$P(t) = t^{n+1} + t^n + P_{\mathbb{E}}(M)(t) + (1+t)K(t) + (1+t)N(t),$$

in the notation above. □

**8.3. Classical Morse estimates in Arnold's example for  $N \times S^1$ .** Consider a germ  $f$  in Arnold's example constructed from a manifold  $M^{n+1}$  which is a product of closed connected manifold  $N$  with  $S^1$ . More precisely, let  $B^{n+1}$  be an embedded into  $N \times S^1$  ball,  $F$  be a strong Morse function on  $N \times S^1$  and  $f$  be a strong Morse germ of  $F$  along  $\partial B^{n+1}$ . We will show that  $P_{\mathbb{E}}(B^{n+1}) - P_-(f, B^{n+1}) = -(1+t)Q(t)$  for a polynomial  $Q$  with non-negative coefficients. It implies that classical Morse inequalities do not guarantee critical points of an extension of  $f$  into  $B^{n+1}$ .

Consider a function  $\tilde{F}$  which is a restriction of  $F$  on  $M_1 = ((N \times S^1) \setminus B^{n+1}) \cup S^n$  and denote its  $M$ -model by  $\mathcal{M}(\tilde{F})$ . Consider the case of orientable manifold  $N$  or  $\text{char}(\mathbb{E}) = 2$ . In that case the global maximum of  $f|_{S^n}$  contributes into the unique glyph of the type , global minimum of  $f|_{S^n}$  contributes into the unique glyph of the type , all other glyphs of  $\mathcal{M}(\tilde{F})$  are of types , ,  and  only, since  $\tilde{F}$  has no critical points and  $\partial M_1 = S^n$ .

The polynomial  $P_-(f, B^{n+1}) - P_{\mathbb{E}}(B^{n+1})$  has the following expression in terms of glyphs contributing into  $\mathcal{M}(\tilde{F})$ :

$$\sum \left( \# \begin{array}{c} \circ \\ \text{---} \\ \circ \\ \text{---} \\ \circ \end{array} + \# \begin{array}{c} \circ \\ \text{---} \\ \circ \\ \text{---} \\ \circ \end{array} + \# \begin{array}{c} \circ \\ \text{---} \\ \circ \\ \text{---} \\ \circ \end{array} \right) t^{k-1}(1+t) + \sum \# \begin{array}{c} \circ \\ \text{---} \\ \circ \end{array} t^{k-1} + t^n - 1.$$

Thus it is sufficient to show that  $\sum \# \text{glyph}_{k-1} t^{k-1} + t^n - 1$  is divisible by  $(1+t)$  and the result of the division is a polynomial with non-negative coefficients. Indeed, the last polynomial equals to  $\frac{1}{t}(P_{\mathbb{E}}(M)(t) - 1) - 1$ . Using Kunnetth formula  $P_{\mathbb{E}}(M)(t) = (1+t)P_{\mathbb{E}}(N)(t)$  we get:  $t^{-1}(P_{\mathbb{E}}(M)(t) - 1) - 1 = t^{-1}(1+t)(P_{\mathbb{E}}(N)(t) - 1)$ . Coefficients of the polynomial  $t^{-1}(P_{\mathbb{E}}(N)(t) - 1)$  are obviously non-negative.

The case when  $N$  is non-orientable and  $\text{char}(\mathbb{E}) \neq 2$  is analogous. The formula for the polynomial  $P_-(f, B^{n+1}) - P_{\mathbb{E}}(B^{n+1})$  differs by the additional summand  $t^{n-1}$ , since global maximum is a part of a basis in a glyph of the type  which contributes  $t^{n-1} + t^n$  in  $P_-(f, B^{n+1})$ . However  $\sum \# \text{glyph}_{k-1} t^{k-1} + t^n + t^{n-1} - 1$  equals  $\frac{1}{t}(P_{\mathbb{E}}(M)(t) - 1) - 1 + t^n + t^{n-1}$  and we can apply considerations above.

8.4. *Realization of glyphs.* . Each glyph appears in an  $M$ -model of a suitable strong Morse function.

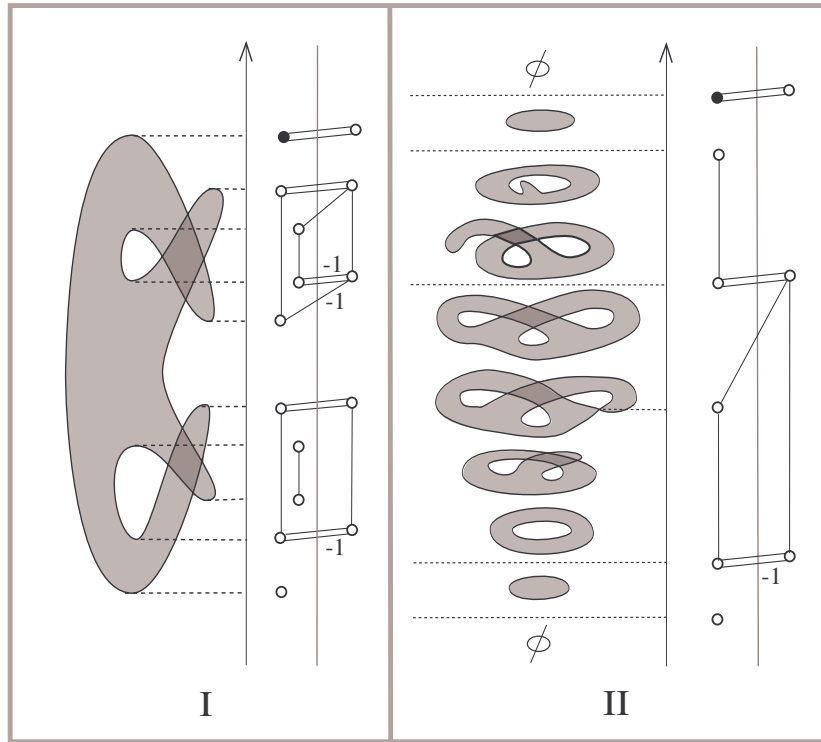

Figure 11. Functions on immersed disks and their  $M$ -models

## 9. CORRECTIONS

- (1) Reference to Arnold problem

- (2) Short intro to Section 3
- (3) Boundary map or connecting homomorphism?
- (4) Check the proof of Lemma 3.1.
- (5) Grading  $-j$  degree
- (6) Nuzhno li Statement PQRDEF?
- (7) Ispravil' dokazatel'stvo lemma 4.\* in view of the definition of weakly equivalence
- (8) Dopisat' v minimal complexes 1. – možno nasil'no opredelit' P po minimal indecomposable. 2. tuda zhe ili kuda-to esche chto ekvivalentnost' zadannaya P, est' "usilenie" ili "oslablenie" slaboj i chto klass P-ekvivalentnosti sodержit konechnoe chislo klassov weak equiv
- (9) proverit', chto gruppa deistvuet  $\partial \rightarrow S\partial S^{-1}$  a ne  $\partial \rightarrow S^{-1}\partial S$
- (10) emptyset -  $j$  varnothing
- (11) grading  $-j$  degree proverit' vsyudu
- (12)  $\mathcal{F}(A)$  ili  $\mathbb{E} \otimes A$  - (ne) sdelat' (li) edinoobrazno.
- (13) kak postavit' kvadrat v vyklyuchnoi formule v konec? (Theorem Morsedecomp for example)
- (14) dobavit' ssylku w d-trivial na primer iz topologii i sootw Lemmu w dokazatel'stve
- (15) proverit', podumat', ne nado li vsyudu zamenit'  $F_a$  na  $M^a$  i  $F_a^\partial$  i  $\partial M^a$
- (16) underlevel or sublevel
- (17) Predlozhenie pro algebr model' podvislo
- (18) znachok izomorphizma  $\sim$  ili *approx*??? Proverit' i vsyudu pomenyat'
- (19) The bibliography - chto nuzhno, chto net.

## REFERENCES

- [1] Arnold, V. I. Arnold's problems (in Russian)// Moscow, FAZIS, 2000.
- [2] S. A. Barannikov, *The framed Morse complex and its invariants*, Advances in Soviet Mathematics, Vol. 21, V. I. Arnold Ed., 1994, 93–115.
- [3] J. Cerf, *Stratification naturelle des espaces de fonctions différentiables réelles et le théorème de la pseudo-isotopie*, Inst. Hautes Études Sci. Publ. Math. **239** (1970), 371–372.
- [4] Chekanov Yu.V., Pushkar' P.E., Combinatorics of wave fronts. Arnold's four-cusp conjecture and invariants of legendrian knots. Russian Math. Surveys. (2005), no. 1.
- [5] S. Blanck, F. Laudenbach, *Extension à une variété de dimension 2 d'un germe de fonction donné le long de bord*, C.R. Acad. Sci., Paris **270**, (1970), 1663–1665.
- [6] C. Curley, *Non-singular extension of Morse functions*, Topology, Vol. 16, (1977), 89–97.
- [7] J. Milnor, *Morse theory*, Annals Studies 51, Princeton, N.J. (1963).
- [8] J. Milnor, *Lectures on the h-cobordism theorem*, Notes by L. Siebenmann and J. Sondow Princeton University Press, Princeton, N.J. 1965 v+116 pp.

- [9] M. Morse, *The analysis and analysis-situs of regular  $n$ -spreads in  $(n+r)$ -space*, Proceedings of the National Academy of Sciences, 13 (1927), 813-817.
- [10] M. Morse, G. B. Van Schaack, *The critical point theory under general boundary conditions*, Ann. of Math. (2) 35 (1934), no. 3, 545-571.
- [11] M. Schwartz, *Morse homology*, Progress in Mathematics, 111. Birkhuser Verlag, Basel, 1993. x+235 pp.
- [12] A. Banyaga, D. Hurtubise, *Lectures on Morse homology*, Kluwer Texts in the Mathematical Sciences, 29. Kluwer Academic Publishers Group, Dordrecht, 2004. x+324 pp.
- [13] F. Laudenbach, appendix to the paper: J-M. Bismut, W. Zhang *An extension of a theorem by Cheeger and Muller*. Asterisque No. 205 (1992), 235 pp.
- [14] Hatcher A., Wagoner J. Pseudo-isotopies of compact manifolds // Asterisque, **6**, 1973, 3-274
- [15] Pushkar, P. E. On functions, all of whose critical points are contained in a ball. Funct. Anal. Appl. 36 (2002), no. 4, 321-323